

CABLE SOLUTIONS FOR ELECTRONIC WIRE & CABLE



Electronic Wire & Cable

This catalog contains in-depth information on the most comprehensive line of copper Electronics products available today for data transmission, sound, security/fire alarm, professional audio and video broadcast.

In a rapidly changing industry with ever-growing demands, Prysmian Group continues to stay ahead of the curve with engineered products that guarantee future performance. Choose from the best cable in its class—CAROL® Brand.

Our products are readily available for immediate shipment through our network of authorized stocking distributors and distribution centers.



All information in this catalog is presented solely as a guide to product selection and is believed to be reliable. All printing errors are subject to correction in subsequent releases of this catalog. Although Prysmian has taken precautions to ensure the accuracy of the product specifications at the time of publication, the specifications of all products contained herein are subject to change without notice.

PRYSMIAN, CAROL, CAROLGRENE, COMMAND SERIES, DEMAND BETTER...EXPECT MORE, FLEXFOIL, LO-CAP, MOISTURE GUARD, ONE COMPANY CONNECTING THE WORLD, PULL-PAC, SMARTWRAP, SPOOL-PAC, SUPERFLEX, WIRE WIZARD and logos are trademarks of Prysmian North America.

© 2024. Prysmian North America.
Highland Heights, KY 41076
All rights reserved. Printed in USA.

Demand Better... Expect More™

FROM CAROL® BRAND

QUALITY



Prysmian is committed to meeting customer requirements through continuous quality improvements. As a significant part of our commitment to quality, Prysmian's manufacturing facilities are certified to the ISO 9001:2015 quality standard. Our telecommunications cable manufacturing facility has received TL 9000 quality standards registration

as a supplement to the ISO program. This quality system is based on the ISO 9001 program with added telecommunications-specific performance metrics. We strive to provide value optimization through innovation and quality solutions.

- Our in-house testing capabilities are extensive, with strict adherence to our product specifications as well as industry standards.
- Cables are safety listed and verified.
- Third-party testing labs like ETL and UL are utilized to quantify and confirm our quality and provide final qualification data that sets the foundation for our extended product warranty.
- Prysmian products have stood the test of time with proven reliability and performance.

CUSTOMER SERVICE



Prysmian is dedicated to customer service and satisfaction. Call our team of professionally trained sales associates at

888-295-5896

with any questions to meet your application needs.

na.prysmian.com

Table of Contents

SECTION

PAGES

1	COMMUNICATION & CONTROL CABLE, MULTI-CONDUCTOR	1-31
•	Multi-Conductor, Unshielded.....	2-13
•	Power-Limited Tray Cable, Unshielded.....	14
•	Multi-Conductor, Foil Shield.....	15-18
•	Multi-Conductor, Foil Shield (CSA).....	19-22
•	Power-Limited Tray Cable, Foil Shield.....	23
•	Multi-Conductor, Spiral Shield.....	24
•	Multi-Conductor, Braid Shield.....	25-27
•	Multi-Conductor, Foil/Braid Shield.....	28
•	Multi-Conductor, Rubber, Unshielded.....	29
•	Multi-Conductor, Rubber, Braid Shield.....	30
•	Multi-Conductor, Carolprene®, Braid Shield.....	31
2	COMMUNICATION & CONTROL CABLE, MULTI-PAIRED	33-45
•	Multi-Paired, Unshielded.....	34-35
•	Multi-Paired, Foil Shield.....	36-39
•	Multi-Paired, Individually Shielded (UL).....	40
•	Multi-Paired, Individually Shielded (CSA).....	41
•	Power-Limited Tray Cable, Individually Shielded.....	42
•	Power-Limited Tray Cable, Foil Shield.....	43
3	COMPUTER CABLE	44-58
•	Multi-Conductor, Foil Shield.....	45-46
•	Multi-Conductor, Foil/Braid Shield.....	47-48
•	Multi-Conductor, Foil/Braid Shield, Lo-Cap.....	49
•	Multi-Paired, Foil Shield.....	50
•	Multi-Paired, Foil Shield, Lo-Cap.....	51
•	Multi-Paired, Foil/Braid Shield.....	52
•	Multi-Paired, Foil/Braid Shield, Lo-Cap.....	53-55
•	Multi-Paired, Individually Foil Shielded.....	56
•	Multi-Paired, Individually Foil Shielded, Lo-Cap.....	57
•	Multi-Paired, Individually Foil/Braid Shielded, Lo-Cap.....	58

Table of Contents

SECTION

PAGES

4	EXZEL® HIGH-ENDURANCE CABLES	59-79
•	CAROL® Brand Exzel® For Complete Peace of Mind.....	60-62
•	Multi-Conductor, Unshielded.....	63
•	Multi-Conductor, Foil Shielded.....	64
•	Multi-Conductor, Foil/Braid Shielded.....	65
•	Multi-Paired, Unshielded.....	66
•	Multi-Paired, Foil Shielded.....	67
•	Multi-Paired, Foil/Braid Shielded.....	68
•	Multi-Conductor, Unshielded, Heavy Duty.....	69
•	Multi-Conductor, Foil Shielded, Heavy Duty.....	70
•	Multi-Conductor, Foil/Braid Shielded, Heavy Duty.....	71
•	Multi-Paired, Foil/Braid Shielded, Heavy Duty.....	72
•	LSZH Multi-Conductor, Unshielded.....	73
•	LSZH Multi-Conductor, Foil Shielded.....	74
•	LSZH Multi-Conductor, Foil/Braid Shielded.....	75
•	LSZH Multi-Paired, Unshielded.....	76
•	LSZH Multi-Paired, Foil Shielded.....	77
•	LSZH Multi-Paired, Foil/Braid Shielded.....	78
•	Color Code Charts.....	79
5	FIRE ALARM CABLES	80-94
•	Multi-Conductor, Unshielded, Non-Plenum.....	81
•	Multi-Conductor, Unshielded, Non-Plenum (CSA).....	82
•	Multi-Conductor, Shielded, Non-Plenum.....	83
•	Multi-Conductor, Shielded, Non-Plenum (CSA).....	84
•	Multi-Conductor, Unshielded, Plenum.....	85-86
•	Multi-Conductor, Shielded, Plenum.....	87-88
•	Multi-Conductor, Unshielded, Plenum.....	89
•	Multi-Conductor, Shielded, Riser.....	90
•	Mid-Capacitance, Unshielded, Riser.....	91
•	Mid-Capacitance, Shielded, Non-Plenum.....	92
•	Mid-Capacitance, Unshielded, Plenum.....	93
•	Mid-Capacitance, Shielded, Plenum.....	94

Table of Contents

SECTION

PAGES

6	SOUND, ALARM & SECURITY CABLE	95-105
	• Composite Access Control Cable, Plenum	96
	• Composite Access Control Cable, Riser	97
	• Multi-Conductor, Unshielded, Riser	98
	• Multi-Conductor, Shielded, Riser	99
	• Multi-Conductor, Unshielded, Plenum	100
	• Multi-Conductor, Shielded, Plenum	101
	• Telephone Station/Intercom & Speaker/Burglar Alarm	102
	• Thermostat Wire Type LVT	103
	• Thermostat Wire Type CL2	104
	• Thermostat Wire, Unjacketed	105
7	CATEGORY CABLES	106-110
	• Category 6A Cable	107-108
	• Category 6 Cable	109
	• Category 5e Cable	110
8	COAXIAL CABLE	111-130
	• RG 6/U Type	112-116
	• RG 8/U Type	117
	• RG 11/U Type	118-120
	• RG 58/U Type	121
	• RG 59/U Type	122-126
	• RG 62/U Type	127
	• RG 174/U Type	128
	• RG 213/U Type	129
	• Twinaxial Cables	130
9	SPECIALTY CABLE	131-141
	• Multi-Conductor, Flexfoil Shield®	132
	• Speaker Wire	133
	• Command® Series Home Entertainment Speaker Cable	134
	• CAROL® Brand DMX Lighting Control Cable	135
	• Special Audio, Communication & Instrumentation	136-137
	• Microphone Cable, Multi-Conductor, Carolprene®	138
	• Irrigation and Landscape Lighting	139-140
	• Low-Voltage Sprinkler Wire	141

Table of Contents

SECTION

PAGES

10	HOOK-UP WIRE	142-148
•	UL 1007, UL 1569, CSA TR-64	143
•	UL 1015, CSA TEW	144
•	UL Types MTW, TFF, AWM & CSA TEW	145
•	Heavy Wall UL Types MTW, AWM, NEC Type THW and CSA TEW	146
•	Rubber/PVC/Polyethylene.....	147
11	TECHNICAL INFORMATION	149-182
•	Insulation & Jacket Properties.....	150
•	Decimal Conversion Factors.....	151
•	Unit Conversion Factors.....	152
•	Temperature Conversion Chart.....	153
•	Conduit Capacity Chart.....	154
•	AWG Conductor Chart.....	155
•	Glossary.....	156-166
•	Abbreviations & Acronyms.....	167-169
•	Product Finder—Hook-Up Wire.....	170
•	Product Finder—Multi-Conductor Cable.....	171-176
•	Belden to CAROL® Brand Cross Reference Index	177-178
•	NEC/CEC Substitution Chart.....	179-180
•	Agency Symbols.....	181
•	Put-Ups and Color Codes.....	182
12	AGENCY APPROVAL INDEX	183-184
•	Agency Approval Index.....	183

Communication & Control Cable, Multi-Conductor 1

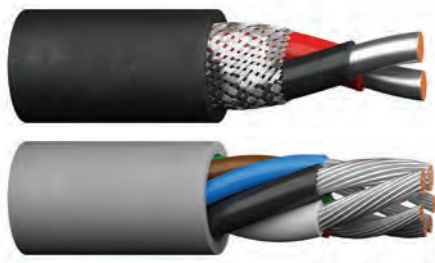

The multi-conductor array of communication and control cable facilitates cable pull-ins and single-site installations.

This cable is typically used for industrial equipment control, electric valve actuation and remote signaling, as well as communications and broadcast applications. These designs are available in a wide variety of insulation and jacketing materials, as well as shield designs to alleviate unwanted circuit noise.

Prysmian’s CAROL® Brand products are manufactured to meet the latest UL, CSA and NEC requirements and approvals.

A Design To Meet Every Application

PVC/PVC designs employ polyvinyl chloride insulations and jackets capable of meeting everyday, general purpose applications.

PE or PP/PVC designs employ high quality polyethylene or polypropylene insulations to assure faithful reproduction of transmitted signals across interconnection circuits.

Foamed PP/PVC designs use high speed, foamed polypropylene insulations for long-distance critical circuits, which would not perform if higher loss insulations were employed.

FEP/FEP designs employ fluoropolymer 200°C-rated materials. They are recommended for use in applications where high temperature, plenum rating, electrical and mechanical safety and chemical resistance are essential.

Rubber/Rubber is typically employed in installations characterized as severely hostile environments, where these designs provide unsurpassed service life.

Rubber/Carolprene® offers the ultimate performance for applications that demand the greatest protection from the environment, including physical abuse. The specially formulated Carolprene® jacket has been proven time and again to withstand all types of abuse, both mechanical and chemical.

Section	Page
Multi-Conductor, Unshielded	2-14
Power-Limited Tray Cable, Unshielded	15
Multi-Conductor, Foil Shield	16-20
Multi-Conductor, Foil Shield (CSA)	21-24
Power-Limited Tray Cable, Foil Shield	25
Multi-Conductor, Spiral Shield	26
Multi-Conductor, Braid Shield	27-29
Multi-Conductor, Foil/Braid Shield	30
Multi-Conductor, Foil & TC Braid Shield	31
Multi-Conductor, Rubber, Unshielded	32
Multi-Conductor, Rubber, Braid Shield	33
Multi-Conductor, Carolprene, Braid Shield	34

Multi-Conductor, Unshielded

UL 2464, NEC/CEC Type CMG UL/CSA**



CATALOG NUMBER	NO. OF COND.	AWG SIZE	COND. STRAND	NOM. INSULATION THICKNESS		NOM. JACKET THICKNESS		NOMINAL O.D.		COLOR CODE	NOM. C-C CAP.* pF/ft
				in	mm	in	mm	in	mm		
C4311A	2	20	Solid	0.010	0.25	0.032	0.81	0.166	4.22	Black/Red	28.0

*Capacitance between conductors

**CSA or c(UL)

Data subject to change.

Product Construction:

Conductor:

- Fully annealed tinned copper per ASTM B33 (C4311A)

Insulation:

- Premium-grade, color-coded PVC

Jacket:

- PVC, gray
- Temperature range: -20°C to +105°C

Applications:

- Public address systems
- Intercoms
- Remote control circuits
- Suggested voltage rating: 300 volts

Compliances:

- NEC Article 800 Type CM (UL: 105°C)
- UL Style 2464 (UL: 80°C, 300 V)
- CSA CMG (CSA: 105°C)
- RoHS Compliant Directive 2015/863/EU (RoHS-3)
- Passes CSA CMG Flame Test
- Sunlight Resistant

Packaging:

- Please contact Customer Service for packaging and color options



Multi-Conductor, Unshielded

UL 2464, NEC/CEC Type CMG UL/CSA**

Product Construction:

Conductor:

- 22 thru 18 fully annealed stranded tinned copper per ASTM B33

Insulation:

- Premium-grade, color-coded PVC
- Color code: See chart below

Jacket:

- PVC, gray
- Temperature range: -20°C to +105°C

Applications:

- TV antenna rotor control
- Satellite actuator control
- Public address systems
- Suggested voltage rating: 300 volts

Compliances:

- NEC Article 800 Type CM (UL: 105°C)
- UL Style 2464 (UL: 80°C, 300 V)
- CSA CMG (CSA: 105°C)
- RoHS Compliant Directive 2015/863/EU (RoHS-3)
- Passes CSA CMG Flame Test
- Sunlight Resistant

Packaging:

- Please contact Customer Service for packaging and color options

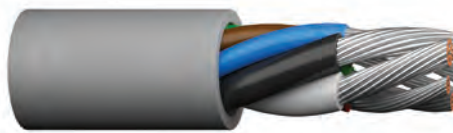

CATALOG NUMBER	NO. OF COND.	AWG SIZE	COND. STRAND	NOM. INSULATION THICKNESS		NOM. JACKET THICKNESS		NOMINAL O.D.		NOM. C-C CAP.* pF/ft
				in	mm	in	mm	in	mm	
C4081A	6	4-22 2-18	7/30 16/30	0.010 0.016	0.25 0.41	0.032	0.81	0.244	6.20	24.5 31.0
C4082A	7	5-22 2-18	7/30 16/30	0.010 0.016	0.25 0.41	0.032	0.81	0.253	6.43	24.5 31.0
C4083A	8	6-22 2-18	7/30 16/30	0.010 0.016	0.25 0.41	0.032	0.81	0.263	6.69	24.5 31.0
C4084A	9	7-22 2-18	7/30 16/30	0.010 0.016	0.25 0.41	0.032	0.81	0.273	6.94	24.5 31.0

*Capacitance between conductors

**CSA or c(UL)

Data subject to change.

COLOR CODE CHART

NO. OF COND.	COLOR
1 18 ga.	Black
2	White
1 22 ga.	Red
2	Green
3	Brown
4	Blue
5	Orange
6	Yellow
7	Purple



Multi-Conductor, Unshielded

UL 2464, UL 2576, NEC/CEC Type CMG UL/CSA**

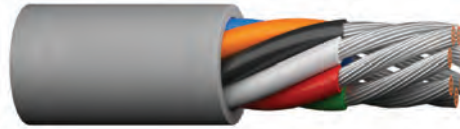

CATALOG NUMBER	NO. OF COND.	AWG SIZE	COND. STRAND	NOM. INSULATION THICKNESS		NOM. JACKET THICKNESS		NOMINAL O.D.		COLOR CODE	NOM. C-C CAP.* pF/ft
				in	mm	in	mm	in	mm		
C2461A	2	24	7/32	0.010	0.25	0.032	0.81	0.152	3.86	Black/Red	23.0
C2462A	3	24	7/32	0.010	0.25	0.032	0.81	0.163	4.14	Black/Red/Green	23.0
C2463A	4	24	7/32	0.010	0.25	0.032	0.81	0.174	4.42	1	23.0
C2464A	5	24	7/32	0.010	0.25	0.032	0.81	0.183	4.75	1	23.0
C2466A	6	24	7/32	0.010	0.25	0.032	0.81	0.200	5.08	1	23.0
C2488A	7	24	7/32	0.010	0.25	0.032	0.81	0.200	5.08	1	23.0
C2465A	8	24	7/32	0.010	0.25	0.032	0.81	0.214	5.44	1	23.0
C2470A	9	24	7/32	0.010	0.25	0.032	0.81	0.227	5.77	1	23.0
C2471A	10	24	7/32	0.010	0.25	0.032	0.81	0.244	6.20	1	23.0
C2467A	12	24	7/32	0.010	0.25	0.032	0.81	0.251	6.38	1	23.0
C2473A	15	24	7/32	0.010	0.25	0.032	0.81	0.275	6.99	2	23.0

*Capacitance between conductors

**CSA or c(UL)

Data subject to change.

COLOR CODE CHART 1

For cables up to and including 12 conductors

NO. OF COND.	COLOR	NO. OF COND.	COLOR	NO. OF COND.	COLOR	NO. OF COND.	COLOR
1	Black	4	Green	7	Orange	10	Gray
2	White	5	Brown	8	Yellow	11	Pink
3	Red	6	Blue	9	Purple	12	Tan

COLOR CODE CHART 2 PER ICEA

For cables with 15 conductors

NO. OF COND.	COLOR	NO. OF COND.	COLOR	NO. OF COND.	COLOR
1	Black	6	Blue	11	Blue/Black
2	White	7	White/Black	12	Black/White
3	Red	8	Red/Black	13	Red/White
4	Green	9	Green/Black	14	Green/White
5	Orange	10	Orange/Black	15	Blue/White

Product Construction:

Conductor:

- 24 AWG fully annealed stranded tinned copper per ASTM B33

Insulation:

- Premium-grade, color-coded PVC
- Color code: See charts below

Jacket:

- PVC, gray
- Temperature range: -20°C to +105°C

Applications:

- Public address systems
- Intercoms
- Internal telephones
- Remote control circuits
- Suitable for EIA RS-232 applications
- Suggested voltage rating: 300 volts

Compliances:

- NEC Article 800 Type CM (UL: 105°C)
- UL Style 2464 (UL: 80°C, 300 V)
- UL Style 2576 (UL: 80°C, 150 V)
- CSA CMG (CSA: 105°C)
- RoHS Compliant Directive 2015/863/EU (RoHS-3)
- Passes CSA CMG Flame Test
- Sunlight Resistant

Packaging:

- Please contact Customer Service for packaging and color options



Multi-Conductor, Unshielded

UL 2464, UL 2576, NEC/CEC Type CMG UL/CSA**

Product Construction:

Conductor:

- 22 AWG fully annealed, stranded tinned copper per ASTM B33

Insulation:

- Premium-grade, color-coded PVC
- Color code: See charts below

Jacket:

- PVC, gray
- Temperature range: -20°C to +105°C

Applications:

- Public address systems
- Intercoms
- Internal telephones
- Remote control circuits
- Suitable for EIA RS-232 applications
- Suggested voltage rating: 300 volts

Compliances:

- NEC Article 800 Type CM (UL: 105°C)
- UL Style 2464 (UL: 80°C, 300 V)
- UL Style 2576 (UL: 80°C, 150 V)
- CSA CMG (CSA 105°C)
- RoHS Compliant Directive 2015/863/EU (RoHS-3)
- Passes CSA CMG Flame Test
- Sunlight Resistant

Packaging:

- Please contact Customer Service for packaging and color options



CATALOG NUMBER	NO. OF COND.	AWG SIZE	COND. STRAND	NOM. INSULATION THICKNESS		NOM. JACKET THICKNESS		NOMINAL O.D.		COLOR CODE	NOM. C-C CAP.* pF/ft
				in	mm	in	mm	in	mm		
C6348A†	2	22	7/30	0.010	0.25	0.015	0.38	0.130	3.30	Black/Red	24.5
C4062A	3	22	7/30	0.010	0.25	0.032	0.81	0.176	4.47	Black/Red/Green	24.5
C4063A	4	22	7/30	0.010	0.25	0.032	0.81	0.182	4.80	1	24.5
C4064A	5	22	7/30	0.010	0.25	0.032	0.81	0.203	5.16	1	24.5
C4066A	6	22	7/30	0.010	0.25	0.032	0.81	0.218	5.54	1	24.5
C4088A	7	22	7/30	0.010	0.25	0.032	0.81	0.205	5.54	1	24.5
C4065A	8	22	7/30	0.010	0.25	0.032	0.81	0.230	5.94	1	24.5
C4070A	9	22	7/30	0.010	0.25	0.032	0.81	0.249	6.32	1	24.5
C4071A	10	22	7/30	0.010	0.25	0.032	0.81	0.268	6.81	1	24.5
C4067A	12	22	7/30	0.010	0.25	0.032	0.81	0.276	7.01	1	24.5
C4073A	15	22	7/30	0.010	0.25	0.032	0.81	0.303	7.70	2	24.5
C4075A	20	22	7/30	0.010	0.25	0.032	0.81	0.334	8.48	2	24.5
C4076A	25	22	7/30	0.010	0.25	0.032	0.81	0.368	9.35	2	24.5
C4077A	30	22	7/30	0.010	0.25	0.032	0.81	0.389	9.88	2	24.5
C4078A	40	22	7/30	0.010	0.25	0.032	0.81	0.434	11.02	2	24.5
C4079A	50	22	7/30	0.010	0.25	0.032	0.81	0.489	12.42	2	24.5

*Capacitance between conductors

**CSA or c(UL)

†CM-CSA CMG Only

Data subject to change.

COLOR CODE CHART 1

For cables up to and including 12 conductors

NO. OF COND.	COLOR	NO. OF COND.	COLOR	NO. OF COND.	COLOR	NO. OF COND.	COLOR
1	Black	4	Green	7	Orange	10	Gray
2	White	5	Brown	8	Yellow	11	Pink
3	Red	6	Blue	9	Purple	12	Tan

COLOR CODE CHART 2 PER ICEA

For cables of 15 thru 50 conductors

NO. OF COND.	COLOR	NO. OF COND.	COLOR	NO. OF COND.	COLOR	NO. OF COND.	COLOR	NO. OF COND.	COLOR
1	Black	11	Blue/Black	21	Orange/Green	31	Green/Black/Orange	41	Green/White/Blue
2	White	12	Black/White	22	Black/White/Red	32	Orange/Black/Green	42	Orange/Red/Green
3	Red	13	Red/White	23	White/Black/Red	33	Blue/White/Orange	43	Blue/Red/Green
4	Green	14	Green/White	24	Red/Black/White	34	Black/White/Orange	44	Black/White/Blue
5	Orange	15	Blue/White	25	Green/Black/White	35	White/Red/Orange	45	White/Black/Blue
6	Blue	16	Black/Red	26	Orange/Black/White	36	Orange/White/Blue	46	Red/White/Blue
7	White/Black	17	White/Red	27	Blue/Black/White	37	White/Red/Blue	47	Green/Orange/Red
8	Red/Black	18	Orange/Red	28	Black/Red/Green	38	Black/White/Green	48	Orange/Red/Blue
9	Green/Black	19	Blue/Red	29	White/Red/Green	39	White/Black/Green	49	Blue/Red/Orange
10	Orange/Black	20	Red/Green	30	Red/Black/Green	40	Red/White/Green	50	Black/Orange/Red



Multi-Conductor, Unshielded

UL 2464, UL 2576, NEC/CEC Type CMG UL/CSA**

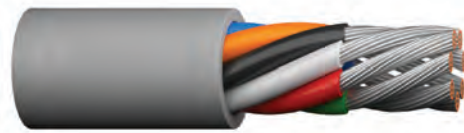

Product Construction:

Conductor:

- 20 or 18 AWG fully annealed stranded, tinned copper per ASTM B33

Insulation:

- Premium-grade, color-coded PVC per UL AWM Style 1007
- Color code: See charts below

Jacket:

- PVC, gray
- Temperature range: -20°C to +105°C

Applications:

- Public address systems
- Intercoms
- Internal telephones
- Remote control circuits
- Suitable for EIA RS-232 applications
- Suggested voltage rating: 300 volts

Compliances:

- NEC Article 800 Type CM (UL: 105°C)
- UL Style 2464 (UL: 80°C, 300 V)
- UL Style 2576 (UL: 80°C, 150 V)
- CSA CMG (CSA: 105°C)
- RoHS Compliant Directive 2015/863/EU (RoHS-3)
- Passes CSA CMG Flame Test
- Sunlight Resistant

Packaging:

- Please contact Customer Service for packaging and color options

CATALOG NUMBER	NO. OF COND.	AWG SIZE	COND. STRAND	NOM. INSULATION THICKNESS		NOM. JACKET THICKNESS		NOMINAL O.D.		COLOR CODE	NOM. C-C CAP.* pF/ft
				in	mm	in	mm	in	mm		
C6351A†	2	20	7/28	0.016	0.41	0.025	0.64	0.192	4.88	Black/Red	28.0
C6352A	3	20	7/28	0.016	0.41	0.032	0.81	0.216	5.50	1	28.0
C6353A	4	20	7/28	0.016	0.41	0.032	0.81	0.235	5.97	1	28.0
C6355A	5	20	7/28	0.016	0.41	0.032	0.81	0.254	6.46	1	28.0
C6356A	7	20	7/28	0.016	0.41	0.032	0.81	0.275	6.99	1	28.0
C6357A	9	20	7/28	0.016	0.41	0.032	0.81	0.317	8.05	1	28.0
C6360A	12	20	7/28	0.016	0.41	0.032	0.81	0.354	9.00	2	28.0
C6358A	15	20	7/28	0.016	0.41	0.032	0.81	0.392	9.96	2	28.0
C2830A†	2	18	16/30	0.016	0.41	0.015	0.64	0.190	5.33	Black/Red	30.5
C2831A	3	18	16/30	0.016	0.41	0.032	0.81	0.236	5.99	1	30.5
C2404A	4	18	16/30	0.016	0.41	0.032	0.81	0.258	6.55	1	30.5
C2420A	5	18	16/30	0.016	0.41	0.032	0.81	0.280	7.11	1	30.5
C2421A	7	18	16/30	0.016	0.41	0.032	0.81	0.309	7.85	1	30.5
C2422A	9	18	16/30	0.016	0.41	0.032	0.81	0.358	9.09	1	30.5
C2412A	12	18	16/30	0.016	0.41	0.032	0.81	0.401	10.19	2	30.5
C2423A	15	18	16/30	0.016	0.41	0.032	0.81	0.445	11.30	2	30.5
C2424A	19	18	16/30	0.016	0.41	0.032	0.81	0.469	11.91	2	30.5
C2433A	25	18	16/30	0.016	0.41	0.032	0.81	0.550	13.94	2	30.5

*Capacitance between conductors

**CSA or c(UL)

†CM (UL) c(UL), CSA CMG Only

Data subject to change.

COLOR CODE CHART 1

For cables up to and including 9 conductors

NO. OF COND.	COLOR	NO. OF COND.	COLOR	NO. OF COND.	COLOR
1	Black	4	Green	7	Orange
2	White	5	Brown	8	Yellow
3	Red	6	Blue	9	Purple

COLOR CODE CHART 2 PER ICEA

For cables of 12 thru 25 conductors

NO. OF COND.	COLOR	NO. OF COND.	COLOR	NO. OF COND.	COLOR	NO. OF COND.	COLOR	NO. OF COND.	COLOR
1	Black	6	Blue	11	Blue/Black	16	Black/Red	21	Orange/Green
2	White	7	White/Black	12	Black/White	17	White/Red	22	Black/White/Red
3	Red	8	Red/Black	13	Red/White	18	Orange/Red	23	White/Black/Red
4	Green	9	Green/Black	14	Green/White	19	Blue/Red	24	Red/Black/White
5	Orange	10	Orange/Black	15	Blue/White	20	Red/Green	25	Green/Black/White



Multi-Conductor, Unshielded

UL 2464, UL 2587, NEC Type CL3, NEC/CEC Type CMG UL/CSA**

Product Construction:

Conductor:

- 16 thru 12 AWG fully annealed stranded tinned copper per ASTM B33

Insulation:

- Premium-grade, color-coded PVC
- Color code: See chart below

Jacket:

- PVC, gray
- Temperature range: -20°C to +105°C



Applications:

- Public address systems
- Intercoms
- Internal telephones
- Remote control circuits
- Suitable for EIA RS-232 applications
- Suggested voltage rating: 300 volts

Compliances:

- NEC Article 725 Type CL3 (UL: 105°C)
- NEC Article 800 Type CM (UL: 105°C)
- UL Style 2464 (UL: 80°C, 300 V)
- UL Style 2587 (UL: 80°C, 600 V)
- CSA CMG (CSA: 105°C)
- RoHS Compliant Directive 2015/863/EU (RoHS-3)
- Passes CSA CMG Flame Test
- Sunlight Resistant

Packaging:

- Please contact Customer Service for packaging and color options

CATALOG NUMBER	NO. OF COND.	AWG SIZE	COND. STRAND	NOM. INSULATION THICKNESS		NOM. JACKET THICKNESS		NOMINAL O.D.		NOM. C-C CAP.* pF/ft
				in	mm	in	mm	in	mm	

NEC TYPE CM, UL STYLE 2464 (80°C, 300 VOLTS)

C2405A	2	16	19/0117	0.021	0.53	0.032	0.81	0.260	6.81	30.5
C2406A	3	16	19/0117	0.021	0.53	0.032	0.81	0.283	7.19	30.5
C2425A	4	16	19/0117	0.021	0.53	0.032	0.81	0.306	7.77	30.5
C2434A	5	16	19/0117	0.021	0.53	0.032	0.81	0.334	8.48	30.5
C2426A	7	16	19/0117	0.021	0.53	0.032	0.81	0.363	9.25	30.5
C2443A	8	16	19/0117	0.021	0.53	0.032	0.81	0.393	10.03	30.5
C2435A	9	16	19/0117	0.021	0.53	0.032	0.81	0.423	10.80	30.5
C2427A	12	16	19/0117	0.021	0.53	0.032	0.81	0.476	12.17	30.5
C2428A	15	16	19/0117	0.021	0.53	0.032	0.81	0.530	13.46	30.5
C2429A	19	16	19/0117	0.021	0.53	0.032	0.81	0.559	14.33	30.5
C2436A	25	16	19/0117	0.021	0.53	0.032	0.81	0.657	16.69	30.5

NEC TYPE CL3, UL STYLE 2587 (90°C, 600 VOLTS)

C2409A	2	14	19/0147	0.032	0.81	0.032	0.81	0.326	8.51	29.0
C2430A	4	14	19/0147	0.032	0.81	0.032	0.81	0.391	9.93	28.2
C2437A	5	14	19/0147	0.032	0.81	0.032	0.81	0.428	10.87	28.2
C2431A	7	14	19/0147	0.032	0.81	0.032	0.81	0.469	11.91	28.2
C2410A	2	12	19/0.0185	0.032	0.81	0.032	0.81	0.366	9.40	31.0
C2440A	4	12	19/0.0185	0.032	0.81	0.032	0.81	0.437	11.02	31.0

*Capacitance between conductors

**CSA or c(UL)

Data subject to change.

COLOR CODE CHART PER ICEA

NO. OF COND.	COLOR	NO. OF COND.	COLOR	NO. OF COND.	COLOR	NO. OF COND.	COLOR	NO. OF COND.	COLOR
1	Black	6	Blue	11	Blue/Black	16	Black/Red	21	Orange/Green
2	White	7	White/Black	12	Black/White	17	White/Red	22	Black/White/Red
3	Red	8	Red/Black	13	Red/White	18	Orange/Red	23	White/Black/Red
4	Green	9	Green/Black	14	Green/White	19	Blue/Red	24	Red/Black/White
5	Orange	10	Orange/Black	15	Blue/White	20	Red/Green	25	Green/Black/White



Multi-Conductor, Unshielded

NEC Type CMP (UL) c(UL) and/or CL2P



Product Construction:

Conductor:

- 22 thru 14 AWG fully annealed stranded tinned or bare copper per ASTM B3, B8 or B33

Insulation:

- Premium-grade, color-coded Flexguard® PVC
- Color code: See chart below

Jacket:

- Fluoropolymer, natural
- Temperature range: -20°C to +75°C
- Sequential footage marked to facilitate installation
- Abrasion-, chemical- and water-resistant
- Includes ripcord

Applications:

- Intercom systems
- Background music
- Audio systems
- Power-limited control circuits
- Suggested voltage rating: 150 volts

Compliances:

- NEC Article 725 (UL: 75°C, 150 V)
- NEC Article 800 (UL: 75°C, 300 V)
- Designed to meet NFPA 262 and CSA FT6 Steiner Tunnel Fire Tests for Plenum Applications

Packaging:

- Please contact Customer Service for packaging and color options

CATALOG NUMBER	NO. OF COND.	AWG SIZE	COND. STRAND	NOM. INSULATION THICKNESS		NOM. JACKET THICKNESS		NOMINAL O.D.		NOM. C-C CAP,* pF/ft
				in	mm	in	mm	in	mm	
C3105†	2	22	7/30 TC	0.006	0.15	0.010	0.25	0.089	2.26	29.0
C3106†	4	22	7/30 TC	0.006	0.15	0.010	0.25	0.121	3.07	29.0
C3102	2	18	7/26 BC	0.008	0.20	0.010	0.25	0.123	3.12	31.0
C3190	3	18	7/26 BC	0.008	0.20	0.010	0.25	0.143	3.63	31.0
C3103	4	18	7/26 BC	0.008	0.20	0.010	0.25	0.163	4.14	31.0
C3134	5	18	7/26 BC	0.008	0.20	0.010	0.25	0.187	4.75	30.8
C3192	6	18	7/26 BC	0.008	0.20	0.010	0.25	0.198	5.03	31.0
C3191	8	18	7/26 BC	0.008	0.20	0.010	0.25	0.223	5.66	31.0
C3178	10	18	7/26 BC	0.008	0.20	0.010	0.25	0.244	6.19	31.0
C3179	12	18	7/26 BC	0.008	0.20	0.010	0.25	0.263	6.68	31.0
C3193	2	16	19/0117 BC	0.008	0.20	0.010	0.25	0.141	3.58	33.0
C3194	3	16	7/0192 BC	0.008	0.20	0.010	0.25	0.164	4.17	33.0
C3195	4	16	7/0192 BC	0.008	0.20	0.010	0.25	0.187	4.75	33.0
C3126†	2	14	19/0147 BC	0.010	0.25	0.010	0.25	0.168	4.27	35.0
C3135†	2	12	19/0185 BC	0.010	0.25	0.010	0.25	0.238	6.05	37.0

*Capacitance between conductors

†CL2P only

Data subject to change.

COLOR CODE CHART

NO. OF COND.	COLOR	NO. OF COND.	COLOR	NO. OF COND.	COLOR	NO. OF COND.	COLOR
1	Black	4	Green	7	Orange	10	Gray
2	White	5	Brown	8	Yellow	11	Pink
3	Red	6	Blue	9	Purple	12	Tan



Designed to Meet
NFPA 262 and CSA FT6
Steiner Tunnel Fire Tests
for Plenum Applications

Underwriters Laboratories Inc.



Multi-Conductor, Unshielded

NEC Type CMP (UL) c(UL) and/or CL3P

Product Construction:

Conductor:

- 22 thru 12 AWG fully annealed solid, stranded tinned or bare copper per ASTM B3, B8 or B33

Insulation:

- Premium-grade, color-coded Flexguard® PVC
- Color code: See chart below

Jacket:

- Flexguard® PVC, natural
- Temperature range: -20°C to +75°C
- Sequential footage marked to facilitate installation
- Includes ripcord

Applications:

- Intercom systems
- Background music
- Audio systems
- Power-limited control circuits
- Suggested voltage rating: 150 volts

Compliances:

- NEC Article 725 (UL: 75°C, 150 V)
- NEC Article 800 (UL: 75°C, 300 V)
- RoHS Compliant Directive 2015/863/EU (RoHS-3)
- Designed to meet NFPA 262 and CSA FT6 Steiner Tunnel Fire Tests for Plenum Applications

Packaging:

- Please contact Customer Service for packaging and color options

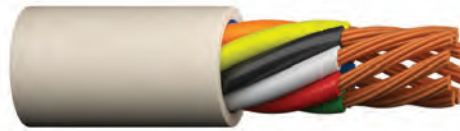

CATALOG NUMBER	NO. OF COND.	AWG SIZE	COND. STRAND	NOM. INSULATION THICKNESS		NOM. JACKET THICKNESS		NOMINAL O.D.		NOM.* C-C CAP. pF/ft
				in	mm	in	mm	in	mm	

22 AWG CONDUCTORS

C3115	2	22	7/32 TC	0.008	0.20	0.015	0.38	0.122	3.10	30.0
C3116	4	22	7/32 TC	0.008	0.20	0.015	0.38	0.141	3.58	30.0

18 AWG CONDUCTORS

C3110	2	18	Solid BC	0.008	0.20	0.015	0.38	0.142	3.61	37.0
C3114	3	18	Solid BC	0.008	0.20	0.015	0.38	0.151	3.84	37.0
C3111	4	18	Solid BC	0.008	0.20	0.015	0.38	0.166	4.22	37.0
C3117	5	18	Solid BC	0.008	0.20	0.015	0.38	0.182	4.62	37.0
C3118	6	18	Solid BC	0.008	0.20	0.015	0.38	0.199	5.05	37.0
C3119	8	18	Solid BC	0.008	0.20	0.015	0.38	0.216	5.49	37.0
C3112	2	18	7/26 BC	0.008	0.20	0.015	0.38	0.156	3.96	35.0
C3120	3	18	7/26 BC	0.008	0.20	0.015	0.38	0.166	4.22	35.0
C3113	4	18	7/26 BC	0.008	0.20	0.015	0.38	0.182	4.62	35.0
C3125	5	18	7/26 BC	0.008	0.20	0.015	0.38	0.200	5.08	54.6
C3121	6	18	7/26 BC	0.008	0.20	0.015	0.38	0.216	5.49	35.0
C3122	8	18	7/26 BC	0.008	0.20	0.015	0.38	0.239	6.07	35.0
C3123	10	18	7/26 BC	0.008	0.20	0.015	0.38	0.278	7.06	35.0
C3124	12	18	7/26 BC	0.008	0.20	0.015	0.38	0.287	7.29	35.0

16 AWG CONDUCTORS

C3127	2	16	19/0117 BC	.009	.227	0.015	0.38	0.178	4.52	40.0
--------------	---	----	------------	------	------	-------	------	-------	------	------

14 AWG CONDUCTORS

C3128†	2	14	19/0147 BC	0.010	0.20	0.015	0.38	0.212	5.38	40.0
---------------	---	----	------------	-------	------	-------	------	-------	------	------

12 AWG CONDUCTORS

C3129†	2	12	19/0185 BC	0.010	0.20	0.015	0.38	0.254	6.45	43.0
---------------	---	----	------------	-------	------	-------	------	-------	------	------

*Capacitance between conductors
 †CL3P only
 Data subject to change.

COLOR CODE CHART

NO. OF COND.	COLOR	NO. OF COND.	COLOR	NO. OF COND.	COLOR	NO. OF COND.	COLOR
1	Black	4	Green	7	Orange	10	Gray
2	White	5	Brown	8	Yellow	11	Pink
3	Red	6	Blue	9	Purple	12	Tan



Underwriters Laboratories Inc.



Multi-Conductor, Unshielded

AWM Style 2464, CSA Type AWM I/II A/B, NEC/CEC Type CMG (CSA C/US)



Product Construction:

Conductor:

- 20 or 18 AWG fully annealed, stranded tinned copper per ASTM B33

Insulation:

- Premium-grade, color-coded PVC
- Color code: See charts below

Jacket:

- PVC, gray
- Temperature range: -20°C to +105°C

Applications:

- Public address systems
- Intercoms
- Internal telephones
- Remote control circuits
- Suitable for EIA RS-232 applications
- Suggested voltage rating: 300 or 600 volts

Compliances:

- AWM Style 2464 (UL: 80°C, 300 V)
- CSA Type AWM (105°C, 600 V)
- CSA Certified CMG to harmonized standard UL 444 and CSA 22.2 No. 214
- NEC/CEC Type CMG (CSA: 105°C, 300 V)
- RoHS Compliant Directive 2015/863/EU (RoHS-3)
- Passes CSA FT4 vertical flame test

Packaging:

- Please contact Customer Service for packaging and color options

CATALOG NUMBER	NO. OF COND.	AWG SIZE	COND. STRAND	NOM. INSULATION THICKNESS		NOM. JACKET THICKNESS		NOMINAL O.D.		COLOR CODE	NOM. C-C CAP.* pF/ft
				in	mm	in	mm	in	mm		
C4117A	2	20	7/28	0.016	0.30	0.032	0.81	0.206	4.67	Black/Red	31.0
C4118A	3	20	7/28	0.016	0.30	0.032	0.81	0.216	4.90	1	31.0
C4119A	4	20	7/28	0.016	0.30	0.032	0.81	0.235	5.31	1	31.0
C4120A	5	20	7/28	0.016	0.30	0.032	0.81	0.254	5.74	1	31.0
C4121A	7	20	7/28	0.016	0.30	0.032	0.81	0.275	6.20	1	31.0
C4122A	9	20	7/28	0.016	0.30	0.032	0.81	0.317	7.14	1	31.0
C4123A	12	20	7/28	0.016	0.30	0.032	0.81	0.354	7.95	2	31.0
C4124A	15	20	7/28	0.016	0.30	0.032	0.81	0.392	8.36	2	31.0
C4125A	2	18	16/30	0.016	0.30	0.032	0.81	0.224	5.13	Black/Red	34.0
C4214A	2	18	16/30	0.016	0.30	0.032	0.81	0.224	5.13	1	34.0
C4126A	3	18	16/30	0.016	0.30	0.032	0.81	0.236	5.41	1	34.0
C4127A	4	18	16/30	0.016	0.30	0.032	0.81	0.258	5.87	1	34.0
C4128A	5	18	16/30	0.016	0.30	0.032	0.81	0.280	6.35	1	34.0
C4206A	6	18	16/30	0.016	0.30	0.032	0.81	0.304	6.76	1	34.0
C4129A	7	18	16/30	0.016	0.30	0.032	0.81	0.309	6.88	1	34.0
C4130A	9	18	16/30	0.016	0.30	0.032	0.81	0.358	7.98	1	34.0
C4131A	12	18	16/30	0.016	0.30	0.032	0.81	0.401	8.92	2	34.0
C4132A	15	18	16/30	0.016	0.30	0.032	0.81	0.445	9.86	2	34.0
C4133A	19	18	16/30	0.016	0.30	0.032	0.81	0.469	10.39	2	34.0
C4134A	25	18	16/30	0.016	0.30	0.032	0.81	0.549	12.14	2	34.0

*Capacitance between conductors
Data subject to change.

COLOR CODE CHART 1

For cables up to and including 9 conductors

NO. OF COND.	COLOR	NO. OF COND.	COLOR	NO. OF COND.	COLOR
1	Black	4	Green	7	Orange
2	White	5	Brown	8	Yellow
3	Red	6	Blue	9	Purple

COLOR CODE CHART 2 PER ICEA

For cables of 12 thru 25 conductors

NO. OF COND.	COLOR	NO. OF COND.	COLOR	NO. OF COND.	COLOR	NO. OF COND.	COLOR	NO. OF COND.	COLOR
1	Black	6	Blue	11	Blue/Black	16	Black/Red	21	Orange/Green
2	White	7	White/Black	12	Black/White	17	White/Red	22	Black/White/Red
3	Red	8	Red/Black	13	Red/White	18	Orange/Red	23	White/Black/Red
4	Green	9	Green/Black	14	Green/White	19	Blue/Red	24	Red/Black/White
5	Orange	10	Orange/Black	15	Blue/White	20	Red/Green	25	Green/Black/White



Multi-Conductor, Unshielded

AWM Styles 2464, 2587, CSA Type AWM I/II A/B, NEC/CEC Type CMG (CSA C/US), or NEC Type CL2

Product Construction:

Conductor:

- 16 thru 12 AWG fully annealed, stranded tinned copper per ASTM B33

Insulation:

- Premium-grade, color-coded PVC
- Color code: See chart below

Jacket:

- PVC, gray
- Temperature range: -20°C to +105°C

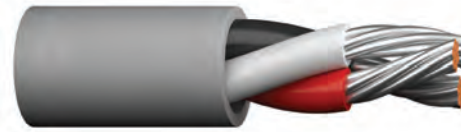

Applications:

- Public address systems
- Intercoms
- Internal telephones
- Remote control circuits
- Suitable for EIA RS-232 applications
- Suggested voltage rating: 300 or 600 volts

Compliances:

- AWM Style 2464 (UL: 80°C, 300 V)
- AWM Style 2587 (UL: 90°C, 600 V)
- CSA Type AWM (105°C, 600 V)
- CSA Certified CMG to harmonized standard UL 444 and CSA 22.2 No. 214
- NEC/CEC Type CMG (CSA: 105°C, 300 V)
- RoHS Compliant Directive 2015/863/EU (RoHS-3)
- Passes CSA FT4 Vertical Flame Test
- UL Certified CL2 to Standard UL 13

Packaging:

- Please contact Customer Service for packaging and color options

CATALOG NUMBER	NO. OF COND.	AWG SIZE	COND. STRAND	NOM. INSULATION THICKNESS		NOM. JACKET THICKNESS		NOMINAL O.D.		NOM. C-C CAP.* pF/ft
				in	mm	in	mm	in	mm	

AWM STYLE 2464, CSA TYPE AWM, CSA C/US TYPE CMG

C4135A	2	16	19/0117	0.021	0.53	0.032	0.81	0.268	6.81	27.0
C4136A	3	16	19/0117	0.021	0.53	0.032	0.81	0.283	7.19	27.0
C4137A	4	16	19/0117	0.021	0.53	0.032	0.81	0.306	7.77	27.0
C4138A	5	16	19/0117	0.021	0.53	0.032	0.81	0.334	8.48	27.0
C4139A	7	16	19/0117	0.021	0.53	0.032	0.81	0.364	9.25	27.0
C4140A	8	16	19/0117	0.021	0.53	0.032	0.81	0.395	10.03	27.0
C4141A	9	16	19/0117	0.021	0.53	0.032	0.81	0.425	10.80	27.0
C4142A	12	16	19/0117	0.021	0.53	0.032	0.81	0.479	12.17	27.0
C4143A	15	16	19/0117	0.021	0.53	0.032	0.81	0.530	13.46	27.0
C4144A	19	16	19/0117	0.021	0.53	0.032	0.81	0.564	14.33	27.0
C4145A	25	16	19/0117	0.021	0.53	0.032	0.81	0.657	16.69	27.0

AWM STYLE 2587, CSA TYPE AWM (FT4), NEC TYPE CL2**

C4146A	2	14	19/0147	0.032	0.81	0.032	0.81	0.334	8.48	25.0
C4147A	4	14	19/0147	0.032	0.81	0.032	0.81	0.391	9.93	25.0
C4148A	5	14	19/0147	0.032	0.81	0.032	0.81	0.428	10.87	25.0
C4149A	7	14	19/0147	0.032	0.81	0.032	0.81	0.469	11.91	25.0
C4150A	2	12	19/0185	0.032	0.81	0.032	0.81	0.370	9.40	29.4
C4151A	4	12	19/0185	0.032	0.81	0.032	0.81	0.434	11.02	29.4

* Capacitance between conductors
Data subject to change.

COLOR CODE CHART 2 PER ICEA

NO. OF COND.	COLOR	NO. OF COND.	COLOR	NO. OF COND.	COLOR	NO. OF COND.	COLOR	NO. OF COND.	COLOR
1	Black	6	Blue	11	Blue/Black	16	Black/Red	21	Orange/Green
2	White	7	White/Black	12	Black/White	17	White/Red	22	Black/White/Red
3	Red	8	Red/Black	13	Red/White	18	Orange/Red	23	White/Black/Red
4	Green	9	Green/Black	14	Green/White	19	Blue/Red	24	Red/Black/White
5	Orange	10	Orange/Black	15	Blue/White	20	Red/Green	25	Green/Black/White



Multi-Conductor, Unshielded

AWM Style 2464, CSA Type AWM I/II A/B, NEC/CEC Type CMG (CSA C/US)

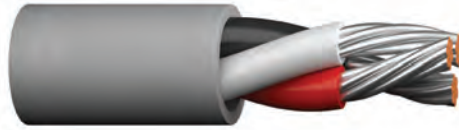

Product Construction:

Conductor:

- 22 AWG fully annealed, stranded tinned copper per ASTM B33

Insulation:

- Premium-grade, color-coded PVC
- Color code: See charts below

Jacket:

- PVC, gray
- Temperature range: -20°C to +105°C

Applications:

- Public address systems
- Intercoms
- Internal telephones
- Remote control circuits
- Suitable for EIA RS-232 applications
- Suggested voltage rating: 300 or 600 volts

Compliances:

- AWM Style 2464 (UL: 80°C, 300 V)
- CSA Type AWM (105°C, 600 V)
- CSA Certified CMG to harmonized standard UL 444 and CSA 22.2 No. 214
- NEC/CEC Type CMG (CSA: 105°C, 300 V)
- RoHS Compliant Directive 2015/863/EU (RoHS-3)
- Passes CSA FT4 vertical flame test

Packaging:

- Please contact Customer Service for packaging and color options

CATALOG NUMBER	NO. OF COND.	AWG SIZE	COND. STRAND	NOM. INSULATION THICKNESS		NOM. JACKET THICKNESS		NOMINAL O.D.		COLOR CODE	NOM. C-C CAP.* pF/ft
				in	mm	in	mm	in	mm		
C4100A	2	22	7/30	0.011	0.28	0.032	0.81	0.165	4.19	Black/Red	27.5
C4101A	3	22	7/30	0.011	0.28	0.032	0.81	0.176	4.47	Black/Red/Green	27.5
C4102A	4	22	7/30	0.011	0.28	0.032	0.81	0.189	4.80	1	27.5
C4103A	5	22	7/30	0.011	0.28	0.032	0.81	0.203	5.16	1	27.5
C4104A	6	22	7/30	0.011	0.28	0.032	0.81	0.208	5.28	1	27.5
C4105A	7	22	7/30	0.011	0.28	0.032	0.81	0.218	5.54	1	27.5
C4106A	8	22	7/30	0.011	0.28	0.032	0.81	0.234	5.94	1	27.5
C4107A	9	22	7/30	0.011	0.28	0.032	0.81	0.249	6.32	1	27.5
C4108A	10	22	7/30	0.011	0.28	0.032	0.81	0.268	6.81	1	27.5
C4109A	12	22	7/30	0.011	0.28	0.032	0.81	0.276	7.01	1	27.5
C4110A	15	22	7/30	0.011	0.28	0.032	0.81	0.303	7.70	2	27.5
C4111A	18	22	7/30	0.011	0.28	0.032	0.81	0.318	8.08	2	27.5
C4112A	20	22	7/30	0.011	0.28	0.032	0.81	0.334	8.48	2	27.5
C4113A	25	22	7/30	0.011	0.28	0.032	0.81	0.368	9.35	2	27.5
C4114A	30	22	7/30	0.011	0.28	0.032	0.81	0.389	9.88	2	27.5
C4115A	40	22	7/30	0.011	0.28	0.032	0.81	0.434	11.02	2	27.5
C4116A	50	22	7/30	0.011	0.28	0.032	0.81	0.489	12.42	2	27.5

*Capacitance between conductors
Data subject to change.

COLOR CODE CHART

For cables up to and including 12 conductors

NO. OF COND.	COLOR	NO. OF COND.	COLOR	NO. OF COND.	COLOR	NO. OF COND.	COLOR
1	Black	4	Green	7	Orange	10	Gray
2	White	5	Brown	8	Yellow	11	Pink
3	Red	6	Blue	9	Purple	12	Tan

COLOR CODE CHART 2 PER ICEA

For cables of 15 thru 50 conductors

NO. OF COND.	COLOR	NO. OF COND.	COLOR	NO. OF COND.	COLOR	NO. OF COND.	COLOR	NO. OF COND.	COLOR
1	Black	11	Blue/Black	21	Orange/Green	31	Green/Black/Orange	41	Green/White/Blue
2	White	12	Black/White	22	Black/White/Red	32	Orange/Black/Green	42	Orange/Red/Green
3	Red	13	Red/White	23	White/Black/Red	33	Blue/White/Orange	43	Blue/Red/Green
4	Green	14	Green/White	24	Red/Black/White	34	Black/White/Orange	44	Black/White/Blue
5	Orange	15	Blue/White	25	Green/Black/White	35	White/Red/Orange	45	White/Black/Blue
6	Blue	16	Black/Red	26	Orange/Black/White	36	Orange/White/Blue	46	Red/White/Blue
7	White/Black	17	White/Red	27	Blue/Black/White	37	White/Red/Blue	47	Green/Orange/Red
8	Red/Black	18	Orange/Red	28	Black/Red/Green	38	Black/White/Green	48	Orange/Red/Blue
9	Green/Black	19	Blue/Red	29	White/Red/Green	39	White/Black/Green	49	Blue/Red/Orange
10	Orange/Black	20	Red/Green	30	Red/Black/Green	40	Red/White/Green	50	Black/Orange/Red



Multi-Conductor, Unshielded

CSA Type AWM I/II A/B, NEC/CEC Type CMG (CSA C/US)

Product Construction:

Conductor:

- 22 thru 14 AWG fully annealed stranded tinned copper per ASTM B33

Insulation:

- Premium-grade, color-coded PVC
- Color code: See charts below

Jacket:

- PVC, gray
- Temperature range: -20°C to +105°C
- Includes ripcord

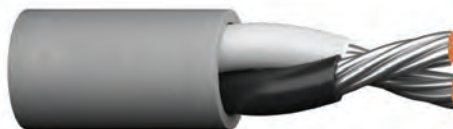

Applications:

- Public address systems
- Intercoms
- Internal telephones
- Suggested voltage rating: 300 or 600 volts

Compliances:

- CSA Type AWM (105°C, 600 V)
- NEC/CEC Type CMG (CSA: 105°C, 300 V)
- RoHS Compliant Directive 2015/863/EU (RoHS-3)
- Passes CSA FT4 Vertical Flame Test

Packaging:

- Please contact Customer Service for packaging and color options

CATALOG NUMBER	NO. OF COND.	AWG SIZE	COND. STRAND	NOM. INS. THICKNESS		NOM. JACKET THICKNESS		NOMINAL O.D.		COLOR CODE	NOM C-C. CAP. pF/ft
				in	mm	in	mm	in	mm		
CSA TYPE AWM, CSA C/US TYPE CMG											
C6700A	2	22	7/30	0.011	0.28	0.016	0.41	0.134	3.40	2	23.5
C6701A	3	22	7/30	0.011	0.28	0.016	0.41	0.142	3.61	2	23.5
C6702A	4	22	7/30	0.011	0.28	0.016	0.41	0.155	3.94	2	23.5
C6704A	6	22	7/30	0.011	0.28	0.016	0.41	0.185	4.70	2	23.5
C6717A	2	20	7/28	0.011	0.28	0.016	0.41	0.148	3.76	2	25.7
C6718A	4	20	7/28	0.011	0.28	0.016	0.41	0.157	3.99	2	25.7
C6725A	2	18	16/30	0.012	0.30	0.016	0.41	0.172	4.37	1	27.3
C6714A	2	18	16/30	0.012	0.30	0.016	0.41	0.172	4.37	2	27.3
C6726A	3	18	16/30	0.012	0.30	0.016	0.41	0.183	4.65	2	27.3
C6727A	4	18	16/30	0.012	0.30	0.016	0.41	0.201	5.11	2	27.3
C6706A	6	18	16/30	0.012	0.30	0.016	0.41	0.242	6.15	2	27.3
C6735A	2	16	19/0117	0.012	0.30	0.016	0.41	0.192	4.88	2	29.4
C6736A	3	16	19/0117	0.012	0.30	0.016	0.41	0.204	5.18	2	29.4
C6737A	4	16	19/0117	0.012	0.30	0.016	0.41	0.226	5.74	2	29.4
CSA TYPE AWM (FT4)											
C6746A	2	14	19/0147	0.015	0.38	0.016	0.41	0.234	5.94	2	30.8
C6747A	4	14	19/0147	0.015	0.38	0.016	0.41	0.276	7.01	2	30.8

*A – Capacitance between conductors

*B – Capacitance between one conductor and other conductors connected to shield
Data subject to change.

COLOR CODE CHART 1

NO. OF COND.	COLOR
1	Black
2	White

COLOR CODE CHART 2

NO. OF COND.	COLOR
1	Black
2	White
3	Red
4	Green
5	Brown
6	Blue
7	Orange
8	Yellow

Power-Limited Tray Cable, Unshielded

NEC Type PLTC, NEC/CEC Type CMG UL/CSA**



Product Construction:

Conductor:

- 22 thru 12 AWG fully annealed stranded tinned copper per ASTM B33

Insulation:

- Premium-grade, color-coded PVC
- Color code: See chart below

Jacket:

- PVC, gray
- Sunlight-resistant
- Temperature range: -20°C to +105°C

Applications:

- Cable tray installations
- Power limited circuits
- Intercom systems
- Business machines
- Cash registers
- Automatic valve control systems
- Irrigation systems
- Suggested voltage rating: 300 volts
- Burglar alarms

Features:

- UL rated for cable tray use

Compliances:

- NEC Article 725 Power-Limited Tray Cable (UL: 105°C, 300 V)
- NEC/CEC Type CMG (UL/CSA: 105°C, 300 V)
- RoHS Compliant Directive 2015/863/EU (RoHS-3)

Packaging:

- Please contact Customer Service for packaging and color options

CATALOG NUMBER	NO. OF COND.	AWG SIZE	COND. STRAND	NOM. INSULATION THICKNESS		NOM. JACKET THICKNESS		NOMINAL O.D.		NOM. C-C CAP.* pF/ft
				in	mm	in	mm	in	mm	
C0431A	2	22	7/30	0.013	0.33	0.037	0.94	0.185	4.70	27.5
C0432A	3	22	7/30	0.013	0.33	0.037	0.94	0.193	4.90	27.5
C0433A	2	20	7/28	0.013	0.33	0.037	0.94	0.198	5.03	30.5
C0434A	3	20	7/28	0.013	0.33	0.037	0.94	0.208	5.28	30.5
C0435A	2	18	16/30	0.013	0.33	0.037	0.94	0.216	5.49	32.5
C0436A	3	18	16/30	0.013	0.33	0.037	0.94	0.227	5.77	32.5
C0444A	4	18	16/30	0.013	0.33	0.037	0.94	0.245	6.22	32.5
C0437A	2	16	19/0117	0.013	0.33	0.037	0.94	0.238	6.05	37.0
C0438A	3	16	19/0117	0.013	0.33	0.037	0.94	0.250	6.35	37.0
C0439A*	2	14	19/0147	0.013	0.33	0.042	1.07	0.278	7.06	40.5
C0440A*	3	14	19/0147	0.013	0.33	0.042	1.07	0.293	7.44	40.5
C0441A*	2	12	19/0185	0.013	0.33	0.042	1.07	0.315	8.00	44.0

*NEC Type PLTC Only

**CSA or c(UL)

Data subject to change.

COLOR CODE CHART

NO. OF COND.	COLOR
1	Black
2	Red
3	White
4	Green



Multi-Conductor, Foil Shield

NEC Type CL2 and CM (UL) c(UL) CMH



Product Construction:

Conductor:

- 24 thru 12 AWG fully annealed solid or stranded tinned copper per ASTM B33

Insulation:

- Premium-grade, color-coded polyethylene
- Premium-grade, color-coded polypropylene
- Color code: See charts below

Shield:

- 100% Flexfoil® aluminum/polyester, 25% overlap, foil facing out
- Stranded tinned copper drain wire

Jacket:

- PVC, gray
- Temperature range: -20°C to +75°C

Applications:

- Recording studios and sound stages
- Broadcast and sound systems
- Computers
- Industrial equipment control
- Suggested voltage rating: 300 or 600 volts

Compliances:

- UL Style 2092 (UL: 60°C, 300 V)
- UL Style 2093 (UL: 60°C, 300 V)
- UL Style 2094 (UL: 60°C, 300 V)
- UL Style 2106 (UL: 60°C, 600 V)
- UL Style 2107 (UL: 60°C, 600 V)
- UL Style 2464 (UL: 80°C, 300 V)
- NEC Article 725 Type CL2 (UL: 75°C)
- NEC Article 800 Type CM (UL: 75°C)
- RoHS Compliant Directive 2011/65/EU
- CSA CMH (CSA: 60°C)
- Passes CSA CMH Flame Test
- CE: Low Voltage Directive (LVD) 2006/95/EC

Packaging:

- Please contact Customer Service for packaging and color options
- Data subject to change.

CATALOG NUMBER	NO. OF COND.	AWG SIZE	COND. STRAND	NOM. INSULATION THICKNESS		NOM. JACKET THICKNESS		NOMINAL O.D.		NOM. CAP.*** pF/ft	
				in	mm	in	mm	in	mm	A	B

UL STYLE 2092, CM (UL) C(UL) CMH, 300 V

C2513A	2	24	7/32	0.016	0.41	0.026	0.66	0.167	4.24	18.0	33.0
C2514A	2	22	7/30	0.016	0.41	0.020	0.51	0.167	4.24	20.0	36.0
C2524A	2	20	7/28	0.016	0.41	0.020	0.51	0.183	4.65	22.5	40.5
C2534A	2	18	16/30	0.016	0.41	0.020	0.51	0.201	5.21	25.5	45.5

Polyethylene Insulation, Color Code Chart #1

UL STYLE 2093, CM (UL) c(UL) CMH, 300 V

C2526A	3	22	7/30	0.016	0.41	0.030	0.76	0.196	4.98	18.5	33.5
C2528A	3	20	7/28	0.016	0.41	0.030	0.76	0.210	5.34	21.0	37.5
C2525A	3	20	7/28	0.016	0.41	0.030	0.76	0.213	5.41	21.0	37.0
C2535A	3	18	16/30	0.016	0.41	0.020	0.51	0.213	5.56	23.0	41.0

Polyethylene Insulation, Color Code Chart #1

UL STYLE 2094, CM (UL) c(UL) CMH, 300 V

C2523A	4	22	7/30	0.016	0.41	0.030	0.76	0.213	5.41	18.5	33.5
C2555A	4	20	7/28	0.016	0.41	0.030	0.76	0.234	5.94	20.5	36.5

Polyethylene Insulation, Color Code Chart #1

UL STYLE 2311, CSA, 600 V

C2536A*	2	16	19/0117	0.031	0.79	0.032	0.81	0.307	7.80	20.0	36.0
C2538A**	2	14	19/0147	0.031	0.79	0.032	0.81	0.335	8.51	23.0	42.0
C2539A**	2	12	19/0185	0.032	0.81	0.032	0.81	0.376	9.55	26.0	46.0

* CM (UL) c(UL) CMH

** CL2

Polyethylene Insulation, Color Code Chart #1

UL STYLE 2464, CL2/CM (UL) c(UL) CMH, 300 V

C2540A	2	20	7/28	0.013	0.33	0.032	0.81	0.194	4.9	49.7	89.5
---------------	---	----	------	-------	------	-------	------	-------	-----	------	------

PVC Insulation, Color Code Chart #2

CM (UL) c(UL) CMH, 300 V

C2515A	2	22	Solid	0.007	0.18	0.020	0.51	0.124	3.15	30.0	55.0
C2516A	2	22	7/30	0.008	0.20	0.020	0.51	0.137	3.48	28.0	51.0
C2517A	3	22	7/30	0.008	0.20	0.020	0.51	0.144	3.36	25.0	45.0

Polypropylene Insulation, Color Code Chart #2

***A – Capacitance between conductors

***B – Capacitance between one conductor and other conductors connected to shield

COLOR CODE CHART 1

NO. OF COND.	COLOR
1	Black
2	Natural
3	Red
4	Green

COLOR CODE CHART 1

NO. OF COND.	COLOR
1	Black
2	Red
3	Neutral



Multi-Conductor, Foil Shield

UL 2092, NEC Type CM (UL) c(UL) CMH



Product Construction:

Conductor:

- 22 thru 18 AWG fully annealed stranded tinned copper per ASTM B33

Insulation:

- Premium-grade, color-coded polyethylene or polypropylene
- Color code: See charts below

Shield:

- 100% aluminum/polyester foil "bonded" to jacket, foil facing in
- Stranded tinned copper drain wire

Jacket:

- PVC, gray
- Temperature range: -20°C to +75°C

Applications:

- Control circuits
- Data and signal transmission
- Computer interconnections
- Suggested voltage rating: 300 volts

Compliances:

- NEC Article 800 Type CM (UL: 75°C)
- UL Style 2092 (UL: 60°C, 300 V)
- CSA CMH (CSA: 60°C)
- CSA CMG (CSA: 60°C)
- RoHS Compliant Directive 2015/863/EU (RoHS-3)
- Passes CSA CMH Flame Test

Packaging:

- Please contact Customer Service for packaging and color options

CATALOG NUMBER	NO. OF COND.	AWG SIZE	COND. STRAND	NOM. INSULATION THICKNESS		NOM. JACKET THICKNESS		NOMINAL O.D.		NOM. CAP.* pF/ft	
				in	mm	in	mm	in	mm	A	B

UL STYLE 2092, CM (UL) C(UL) CMH, 300 V

C2518A	2	22	7/30	0.016	0.41	0.026	0.66	0.181	4.60	20.0	36.0
C2519A	2	20	7/28	0.016	0.41	0.028	0.71	0.201	5.11	21.5	38.5
C2521A	2	18	16/30	0.018	0.46	0.028	0.71	0.229	5.82	23.5	43.0

Polyethylene Insulation, Color Code Chart #1

CM (UL) C(UL) CMH, CSA CMG, 300 V

C2520A	2	22	7/30	0.008	0.20	0.020	0.51	0.137	3.48	28.0	50.0
---------------	---	----	------	-------	------	-------	------	-------	------	------	------

Polypropylene Insulation, Color Code Chart #2

*A – Capacitance between conductors

*B – Capacitance between one conductor and other conductors connected to shield

Data subject to change.

COLOR CODE CHART 1

NO. OF COND.	COLOR
1	Black
2	Neutral

COLOR CODE CHART 2

NO. OF COND.	COLOR
1	Black
2	Red



Multi-Conductor, Foil Shield

UL 2464, NEC/CEC Type CMG UL/CSA**

Product Construction:

Conductor:

- 18 AWG fully annealed stranded tinned copper per ASTM B33

Insulation:

- Premium-grade, color-coded PVC
- Color code: See chart below

Shield:

- 100% Flexfoil® aluminum/polyester, 25% overlap, foil facing out
- Stranded tinned copper drain wire

Jacket:

- PVC, gray
- Temperature range: -20°C to +105°C

Applications:

- Audio, broadcast, instrumentation and sound systems
- Suggested voltage rating: 300 volts

Compliances:

- NEC Article 800 Type CM (UL: 105°C)
- UL Style 2464 (UL: 105°C, 300 V)
- CSA CMG (105°C)
- RoHS Compliant Directive 2015/863/EU (RoHS-3)
- Passes CSA CMG Flame Test

Packaging:

- Please contact Customer Service for packaging and color options

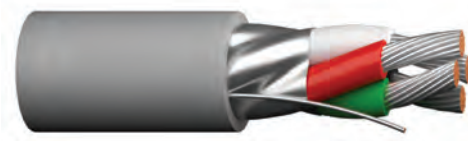

CATALOG NUMBER	NO. OF COND.	AWG SIZE	COND. STRAND	NOM. INSULATION THICKNESS		NOM. JACKET THICKNESS		NOMINAL O.D.		NOM. CAP.* pF/ft	
				in	mm	in	mm	in	mm	A	B
C2543A	4	18	19/30	0.010	0.25	0.032	0.81	0.238	6.05	47	84.5

*A – Capacitance between conductors

*B – Capacitance between one conductor and other conductors connected to shield

**CSA or c(UL)

Data subject to change.

COLOR CODE CHART

NO. OF COND.	COLOR
1	Black
2	Red
3	White
4	Green



Multi-Conductor, Foil Shield

NEC Type CMP (UL) c(UL) and CL3P



Product Construction:

Conductor:

- 22 thru 16 AWG fully annealed stranded tinned or bare copper per ASTM B3, B8 or B33

Insulation:

- Premium-grade, color-coded Flexguard® PVC
- Color code: See chart below

Shield:

- 100% Flexfoil® aluminum/polyester foil with 25% overlap, minimum
- Stranded tinned copper drain wire

Jacket:

- Flexguard® PVC, natural
- Temperature range: -20°C to +75°C
- Sequential footage marked to facilitate installation
- Includes ripcord

Applications:

- Intercom systems
- Background music
- Audio systems
- Power-limited control circuits
- Suggested voltage rating: 300 volts

Compliances:

- NEC Article 725 (UL: 75°C, 150 V)
- NEC Article 800 (UL: 75°C, 300 V)
- RoHS Compliant Directive 2011/65/EU
- Designed to meet NFPA 262 and CSA FT6 Steiner Tunnel Fire Tests for Plenum Applications

Packaging:

- Please contact Customer Service for packaging and color options

CATALOG NUMBER	NO. OF COND.	AWG SIZE	COND. STRAND	NOM. INSULATION THICKNESS		NOM. JACKET THICKNESS		NOMINAL O.D.		NOM. CAP.*	
				in	mm	in	mm	in	mm	A	B
C3158	2	22	7/30 TC	0.008	0.20	0.015	0.38	0.127	3.23	51.0	91.0
C3159	4	22	7/30 TC	0.008	0.20	0.015	0.38	0.146	3.71	45.0	81.0
C3060	2	18	Solid BC	0.008	0.20	0.015	0.38	0.148	3.76	67.0	120.0
C3061	4	18	Solid BC	0.008	0.20	0.015	0.38	0.171	4.34	58.0	104.0
C3062	2	18	7/26 BC	0.008	0.20	0.015	0.38	0.164	4.17	61.0	110.0
C3064	3	18	7/26 BC	0.008	0.20	0.015	0.38	0.169	4.29	53.0	96.0
C3063	4	18	7/26 BC	0.008	0.20	0.015	0.38	0.185	4.70	53.0	96.0
C3065	6	18	7/26 BC	0.010	0.25	0.015	0.38	0.230	5.84	48.0	86.0
C3183	10	18	7/26 BC	0.010	0.25	0.015	0.38	0.295	7.49	47.0	84.0
C3184	12	18	7/26 BC	0.010	0.25	0.015	0.38	0.308	7.82	52.5	94.6
C3068	2	16	19/0117 BC	0.009	0.23	0.015	0.38	0.187	4.75	75.0	134.0

*A – Capacitance between conductors

*B – Capacitance between one conductor and other conductors connected to shield

Data subject to change.

COLOR CODE CHART 2

NO. OF COND.	COLOR
1	Black
2	White
3	Red
4	Green
5	Brown
6	Blue
7	Orange
8	Yellow
9	Purple
10	Gray
11	Pink
12	Tan



Designed to Meet
NFPA 262 and CSA FT6
Steiner Tunnel Fire Tests
for Plenum Applications

Underwriters Laboratories Inc.



Multi-Conductor, Foil Shield

Various AWM Styles, CSA Type AWM I/II A/B, NEC/CEC Type CMG (CSA C/US), NEC Type CL2

Product Construction:

Conductor:

- 24 thru 12 AWG fully annealed solid or stranded tinned copper per ASTM B33

Insulation:

- Premium-grade, color-coded polypropylene
- Color code: See charts below

Shield:

- 100% Flexfoil® aluminum/polyester, 25% overlap, foil facing out
- Stranded tinned copper drain wire

Jacket:

- PVC, gray
- Temperature range: -20°C to +80°C

Applications:

- Recording studios and sound stages
- Broadcast and sound systems
- Computers
- Industrial equipment control
- Suggested voltage rating: 300 or 600 volts

Compliances:

- AWM Style 2772 (UL: 60°C,
- CSA Type AWM (80°C, 600 V)
- CSA Certified CMG to harmonized standard UL 444 and CSA 22.2 No. 214
- NEC Type CL2/CEC Type CMG (CSA: 75°C, 300 V)
- RoHS Compliant Directive 2015/863/EU (RoHS-3)
- Passes CSA FT4 Vertical Flame Test

Packaging:

- Please contact Customer Service for packaging and color options



CATALOG NUMBER	NO. OF COND.	AWG SIZE	COND. STRAND	NOM. INSULATION THICKNESS		NOM. JACKET THICKNESS		NOMINAL O.D.		NOM. CAP.* pF/ft	
				in	mm	in	mm	in	mm	A	B

AWM STYLE 2772, CSA TYPE AWM, CSA C/US TYPE CMG

C4152A	2	24	7/32	0.016	0.41	0.030	0.66	0.167	4.24	23.0	42.0
C4153A	2	22	7/30	0.016	0.41	0.030	0.66	0.179	4.55	21.0	38.0
C4154A	2	20	7/28	0.016	0.41	0.030	0.76	0.203	5.16	22.0	40.0
C4155A	2	18	16/30	0.018	0.46	0.030	0.76	0.233	5.92	24.0	43.0
C4156A	3	22	7/30	0.016	0.41	0.030	0.76	0.196	4.98	25.0	45.0
C4157A	3	20	7/28	0.016	0.41	0.030	0.76	0.210	5.33	27.0	51.0
C4158A	3	20	7/28	0.016	0.41	0.030	0.76	0.213	5.41	29.0	52.0
C4159A	3	18	16/30	0.018	0.46	0.030	0.76	0.247	6.27	22.0	40.0
C4160A	4	22	7/30	0.016	0.41	0.030	0.76	0.213	5.41	23.0	42.0
C4161A	4	20	7/28	0.016	0.41	0.030	0.76	0.234	5.94	26.0	74.0

Color Code Chart #1

AWM STYLE 2311, CSA TYPE AWM, CSA C/US TYPE CMG

C4162A	2	16	19/0117	0.032	0.81	0.032	0.81	0.307	7.80	27.0	49.0
---------------	---	----	---------	-------	------	-------	------	-------	------	------	------

Color Code Chart #1

NEC TYPE CL2, AWM STYLE 2464, CSA TYPE AWM

C4163A	2	14	41/30	0.020	0.51	0.032	0.81	0.298	7.57	31.0	56.0
---------------	---	----	-------	-------	------	-------	------	-------	------	------	------

Color Code Chart #3

NEC TYPE CL2, AWM STYLE 2311, CSA TYPE AWM

C4164A	2	12	19/0185	0.032	0.81	0.040	1.02	0.390	9.90	35.0	63.0
---------------	---	----	---------	-------	------	-------	------	-------	------	------	------

Color Code Chart #1

AWM STYLE 2094, CSA TYPE AWM, CSA C/US TYPE CMG

C4167A	2	22	Solid	0.016	0.18	0.020	0.51	0.124	3.15	40.0	76.0
C4168A	2	22	7/30	0.016	0.20	0.020	0.51	0.137	3.48	34.0	67.0
C4169A	3	22	7/30	0.016	0.20	0.020	0.51	0.144	3.66	32.0	60.0

Polyethylene Insulation, Color Code Chart #2

*A - Capacitance between conductors

*B - Capacitance between one conductor and other conductors connected to shield

Data subject to change.

COLOR CODE CHART 1

NO. OF COND.	COLOR
1	Black
2	Natural
3	Red
4	Green

COLOR CODE CHART 2

NO. OF COND.	COLOR
1	Black
2	Red
3	Clear

COLOR CODE CHART 3

NO. OF COND.	COLOR
1	Black
2	White

Multi-Conductor, Foil Shield

AWM Styles 2464, CSA Type AWM I/II A/B, NEC/CEC Type CMG (CSA C/US), or NEC Type CL2



Product Construction:

Conductor:

- 22 thru 12 AWG fully annealed stranded tinned copper per ASTM B33

Insulation:

- Premium-grade, color-coded PVC
- Color code: See charts below

Shield:

- 100% Flexfoil® aluminum/polyester, 25% overlap, foil facing out
- Stranded tinned copper drain wire

Jacket:

- PVC, gray
- Temperature range: -20°C to +105°C

Applications:

- Recording studios and sound stages
- Broadcast and sound systems
- Industrial equipment control
- Suitable for EIA RS-232 applications
- Suggested voltage rating: 300 or 600 volts

Compliances:

- AWM Style 2464 (UL: 80°C, 300 V)
- CSA Type AWM (105°C, 600 V)
- CSA Certified CMG to harmonized standard UL 444 and CSA 22.2 No. 214
- NEC/CEC Type CMG (CSA: 105°C, 300 V)
- RoHS Compliant Directive 2015/863/EU (RoHS-3)
- Passes CSA FT4 Vertical Flame Test
- UL Certified CL2 to Standard UL 13
- Sunlight Resistant

Packaging:

- Please contact Customer Service for packaging and color options

CATALOG NUMBER	NO. OF COND.	AWG SIZE	COND. STRAND	NOM. INSULATION THICKNESS		NOM. JACKET THICKNESS		NOMINAL O.D.		COLOR CODE	NOM. CAP.* pF/ft	
				in	mm	in	mm	in	mm		A	B

AWM STYLE 2464, CSA TYPE AWM, CSA C/US TYPE CMG

C4192A	2	22	7/30	0.011	0.28	0.032	0.81	0.171	4.34	1	47.0	85.0
C4210A	2	22	7/30	0.011	0.28	0.032	0.81	0.171	4.34	2	47.0	85.0
C4193A	3	22	7/30	0.011	0.28	0.032	0.81	0.179	4.55	2	43.0	76.0
C4194A	4	22	7/30	0.011	0.28	0.032	0.81	0.192	4.88	2	43.0	76.0
C4207A	6	22	7/30	0.011	0.28	0.032	0.81	0.218	5.54	2	43.0	76.0
C4208A	8	22	7/30	0.011	0.28	0.032	0.81	0.238	6.05	2	43.0	76.0
C4166A	2	20	7/28	0.012	0.30	0.032	0.81	0.189	4.80	1	46.0	83.0
C4211A	2	20	7/28	0.012	0.30	0.032	0.81	0.189	4.80	2	46.0	83.0
C4195A	3	20	7/28	0.012	0.30	0.032	0.81	0.200	5.08	2	42.0	75.0
C4196A	4	20	7/28	0.012	0.30	0.032	0.81	0.216	5.49	2	42.0	75.0
C4197A	2	18	16/30	0.012	0.30	0.032	0.81	0.205	5.20	1	51.0	92.0
C4212A	2	18	16/30	0.012	0.30	0.032	0.81	0.205	5.20	2	51.0	92.0
C4198A	3	18	16/30	0.012	0.30	0.032	0.81	0.214	5.44	2	46.0	83.0
C4204A	4	18	16/30	0.012	0.30	0.032	0.81	0.236	5.99	2	46.0	83.0
C4205A	6	18	16/30	0.012	0.30	0.032	0.81	0.271	6.88	2	46.0	83.0
C4199A	2	16	19/0117	0.012	0.30	0.032	0.81	0.229	5.82	1	62.0	112.0
C4213A	2	16	19/0117	0.012	0.30	0.032	0.81	0.229	5.82	2	62.0	112.0
C4200A	3	16	19/0117	0.012	0.30	0.032	0.81	0.241	6.12	2	58.0	104.0

AWM STYLE 2464, CSA TYPE AWM (FT4), NEC TYPE CL2*

C4201A	2	14	19/0147	0.015	0.38	0.032	0.81	0.271	6.88	1	60.0	107.0
C4215A	2	14	19/0147	0.015	0.38	0.032	0.81	0.271	6.88	2	60.0	107.0
C4202A	2	12	19/0185	0.015	0.38	0.032	0.81	0.307	7.80	1	64.0	116.0

*A – Capacitance between conductors

*B – Capacitance between one conductor and other conductors connected to shield

Data subject to change.

COLOR CODE CHART 1

NO. OF COND.	COLOR
1	Black
2	Red

COLOR CODE CHART 2

For cables up to and including 9 conductors

NO. OF COND.	COLOR	NO. OF COND.	COLOR
1	Black	5	Brown
2	White	6	Blue
3	Red	7	Orange
4	Green	8	Yellow



Multi-Conductor, Foil Shield

AWM Style 2464, CSA Type AWM I/II A/B, NEC/CEC Type CMG (CSA C/US)

Product Construction:

Conductor:

- 24 AWG fully annealed stranded tinned copper per ASTM B33

Insulation:

- Premium-grade, color-coded PVC
- Color code: See charts below

Shield:

- 100% Flexfoil® aluminum/polyester with 25% overlap, foil facing out
- Stranded tinned copper drain wire

Jacket:

- PVC, gray
- Temperature range: -20°C to +105°C

Applications:

- Computer interconnections
- Data transmission
- Control circuits
- Industrial equipment control
- Suitable for EIA RS-232 applications
- Suggested voltage rating: 300 or 600 volts

Compliances:

- AWM Style 2464 (UL: 80°C, 300 V)
- CSA Type AWM (105°C, 600 V)
- CSA Certified CMG to harmonized standard UL 444 and CSA 22.2 No. 214
- NEC/CEC Type CMG (CSA: 105°C, 300 V)
- RoHS Compliant Directive 2015/863/EU (RoHS-3)
- Passes CSA FT4 Vertical Flame Test

Packaging:

- Please contact Customer Service for packaging and color options



CATALOG NUMBER	NO. OF COND.	AWG SIZE	COND. STRAND	NOMINAL INSULATION THICKNESS		NOMINAL JACKET THICKNESS		NOMINAL O.D.		NOMINAL DCR Ω/kft @20°C		NOMINAL CAP.* pF/ft	
				in	mm	in	mm	in	mm	COND.	SHLD.	A	B

AWM STYLE 2464, CSA TYPE AWM, CSA C/US TYPE CMG

C4216A	2	24	7/32	0.010	0.25	0.032	0.81	0.157	3.99	27.7	18.0	40.0	72.0
C4217A	3	24	7/32	0.010	0.25	0.032	0.81	0.164	4.17	27.7	18.0	36.0	66.0
C4218A	4	24	7/32	0.010	0.25	0.032	0.81	0.175	4.45	27.7	18.0	36.0	66.0
C4219A	5	24	7/32	0.010	0.25	0.032	0.81	0.188	4.78	27.7	16.0	36.0	66.0
C4220A	6	24	7/32	0.010	0.25	0.032	0.81	0.201	5.11	27.7	16.0	34.0	61.0
C4221A	7	24	7/32	0.010	0.25	0.032	0.81	0.201	5.11	27.7	16.0	34.0	61.0
C4222A	8	24	7/32	0.010	0.25	0.032	0.81	0.215	5.46	27.7	16.0	34.0	61.0
C4223A	9	24	7/32	0.010	0.25	0.032	0.81	0.228	5.79	27.7	16.0	34.0	61.0
C4224A	10	24	7/32	0.010	0.25	0.032	0.81	0.245	6.22	27.7	14.0	34.0	61.0

Color Code Chart #1

C4225A	15	24	7/32	0.010	0.25	0.032	0.81	0.276	7.01	27.7	14.0	34.0	61.0
C4226A	20	24	7/32	0.010	0.25	0.032	0.81	0.303	7.70	27.7	14.0	34.0	61.0
C4227A	25	24	7/32	0.010	0.25	0.032	0.81	0.333	8.46	27.7	12.0	34.0	61.0
C4228A	30	24	7/32	0.010	0.25	0.032	0.81	0.351	8.92	27.7	12.0	34.0	61.0
C4229A	40	24	7/32	0.010	0.25	0.032	0.81	0.391	9.93	27.7	12.0	34.0	61.0
C4230A	50	24	7/32	0.010	0.25	0.032	0.81	0.439	11.15	27.7	10.0	34.0	61.0

Color Code Chart #2

*A – Capacitance between conductors

*B – Capacitance between one conductor and other conductors connected to shield

Data subject to change.

COLOR CODE CHART

For cables up to and including 10 conductors

NO. OF COND.	COLOR	NO. OF COND.	COLOR	NO. OF COND.	COLOR	NO. OF COND.	COLOR
1	Black	4	Green	7	Orange	10	Gray
2	White	5	Brown	8	Yellow		
3	Red	6	Blue	9	Purple		

COLOR CODE CHART 2 PER ICEA

For cables of 15 thru 50 conductors

NO. OF COND.	COLOR	NO. OF COND.	COLOR	NO. OF COND.	COLOR	NO. OF COND.	COLOR	NO. OF COND.	COLOR
1	Black	11	Blue/Black	21	Orange/Green	31	Green/Black/Orange	41	Green/White/Blue
2	White	12	Black/White	22	Black/White/Red	32	Orange/Black/Green	42	Orange/Red/Green
3	Red	13	Red/White	23	White/Black/Red	33	Blue/White/Orange	43	Blue/Red/Green
4	Green	14	Green/White	24	Red/Black/White	34	Black/White/Orange	44	Black/White/Blue
5	Orange	15	Blue/White	25	Green/Black/White	35	White/Red/Orange	45	White/Black/Blue
6	Blue	16	Black/Red	26	Orange/Black/White	36	Orange/White/Blue	46	Red/White/Blue
7	White/Black	17	White/Red	27	Blue/Black/White	37	White/Red/Blue	47	Green/Orange/Red
8	Red/Black	18	Orange/Red	28	Black/Red/Green	38	Black/White/Green	48	Orange/Red/Blue
9	Green/Black	19	Blue/Red	29	White/Red/Green	39	White/Black/Green	49	Blue/Red/Orange
10	Orange/Black	20	Red/Green	30	Red/Black/Green	40	Red/White/Green	50	Black/Orange/Red



Multi-Conductor, Foil Shield

CSA Type AWM I/II A/B, NEC/CEC Type CMG (CSA C/US)



Product Construction:

Conductor:

- 22 thru 14 AWG fully annealed stranded tinned copper per ASTM B33

Insulation:

- Premium-grade, color-coded PVC
- Color code: See charts below

Shield:

- 100% Flexfoil® aluminum/polyester foil with 25% overlap, minimum
- Stranded tinned copper drain wire

Jacket:

- PVC, gray
- Temperature range: -20°C to +105°C
- Includes ripcord

Applications:

- Recording studios and sound stages
- Broadcast and sound systems
- Suggested voltage rating: 300 or 600 volts

Compliances:

- CSA Type AWM (105°C, 600 V)
- NEC/CEC Type CMG (CSA: 105°C, 300 V)
- RoHS Compliant Directive 2015/863/EU (RoHS-3)
- Passes CSA FT4 Vertical Flame Test

Packaging:

- Please contact Customer Service for packaging and color options

CATALOG NUMBER	NO. OF COND.	AWG SIZE	COND. STRAND	NOM. INS. THICKNESS		NOM. JACKET THICKNESS		NOMINAL O.D.		COLOR CODE	NOM. CAP.* pF/ft	
				in	mm	in	mm	in	mm		A	B

CSA TYPE AWM, CSA C/US TYPE CMG

C6892A	2	22	7/30	0.011	0.28	0.016	0.41	0.139	3.53	1	37.7	67.8
C6810A	2	22	7/30	0.011	0.28	0.016	0.41	0.139	3.53	2	37.7	67.8
C6893A	3	22	7/30	0.011	0.28	0.016	0.41	0.147	3.73	2	34.3	61.7
C6894A	4	22	7/30	0.011	0.28	0.016	0.41	0.160	4.06	2	34.3	61.7
C6807A	6	22	7/30	0.011	0.28	0.016	0.41	0.190	4.83	2	31.7	57.0
C6866A	2	20	7/28	0.011	0.28	0.016	0.41	0.153	3.89	1	42.2	76.0
C6811A	2	20	7/28	0.011	0.28	0.016	0.41	0.153	3.89	2	38.0	68.4
C6896A	4	20	7/28	0.011	0.28	0.016	0.41	0.177	4.50	2	34.8	62.7
C6897A	2	18	16/30	0.012	0.30	0.016	0.41	0.175	4.45	1	45.4	81.6
C6812A	2	18	16/30	0.012	0.30	0.016	0.41	0.175	4.45	2	45.4	81.6
C6898A	3	18	16/30	0.012	0.30	0.016	0.41	0.185	4.70	2	40.5	72.9
C6804A	4	18	16/30	0.012	0.30	0.016	0.41	0.204	5.18	2	40.5	72.9
C6805A	6	18	16/30	0.012	0.30	0.016	0.41	0.244	6.20	2	36.9	68.4
C6899A	2	16	19/0117	0.012	0.30	0.016	0.41	0.197	5.00	1	53.6	96.4
C6813A	2	16	19/0117	0.012	0.30	0.016	0.41	0.197	5.00	2	53.6	96.4
C6800A	3	16	19/0117	0.012	0.30	0.016	0.41	0.209	5.31	2	47.0	84.6
C6837A	4	16	19/0117	0.012	0.30	0.016	0.41	0.231	5.87	2	47.0	84.6

CSA TYPE AWM (FT4)

C6801A	2	14	19/0147	0.015	0.38	0.016	0.41	0.239	6.07	1	54.0	97.2
C6815A	2	14	19/0147	0.015	0.38	0.016	0.41	0.239	6.07	2	54.0	97.2

*A – Capacitance between conductors

*B – Capacitance between one conductor and other conductors connected to shield

Data subject to change.

COLOR CODE CHART 1

NO. OF COND.	COLOR
1	Black
2	Red

COLOR CODE CHART 2

NO. OF COND.	COLOR	NO. OF COND.	COLOR
1	Black	5	Brown
2	White	6	Blue
3	Red	7	Orange
4	Green	8	Yellow

Power-Limited Tray Cable, Foil Shield

NEC Type PLTC, NEC/CEC Type CMG UL/CSA**

Product Construction:

Conductor:

- 22 thru 12 AWG fully annealed stranded tinned copper per ASTM B33

Insulation:

- Premium-grade, color-coded PVC
- Color code: See chart below

Shield:

- 100% Flexfoil® aluminum/polyester, 25% overlap foil facing out
- Stranded tinned copper drain wire

Jacket:

- PVC, gray
- Sunlight-resistant
- Temperature range: -20°C to +105°C

Applications:

- Cable tray installations
- Power limited circuits
- Intercom systems
- Business machines
- Cash registers
- Industrial control systems
- Petrochemical refineries
- Suggested voltage rating: 300 volts
- Burglar alarms
- UL tray cable rated

Compliances:

- NEC Article 725 Power-Limited Tray Cable (UL: 105°C, 300 V)
- NEC/CEC Type CMG (UL/CSA: 105°C, 300 V)
- RoHS Compliant Directive 2015/863/EU (RoHS-3)

Packaging:

- Please contact Customer Service for packaging and color options



CATALOG NUMBER	NO. OF COND.	AWG SIZE	COND. STRAND	NOM. INSULATION THICKNESS		NOM. JACKET THICKNESS		NOMINAL O.D.		NOM. CAP.* pF/ft	
				in	mm	in	mm	in	mm	A	B
C0450A	2	22	7/30	0.013	0.33	0.037	0.94	0.191	4.85	43.0	77.5
C0451A	3	22	7/30	0.013	0.33	0.037	0.94	0.199	5.05	39.5	71.0
C0452A	2	20	7/28	0.013	0.33	0.037	0.94	0.207	5.26	48.5	87.0
C0453A	3	20	7/28	0.013	0.33	0.037	0.94	0.217	5.51	44.0	79.0
C0454A	2	18	16/30	0.013	0.33	0.037	0.94	0.221	5.61	54.5	98.0
C0455A	3	18	16/30	0.013	0.33	0.037	0.94	0.232	5.89	49.0	88.0
C0456A	2	16	19/0117	0.013	0.33	0.037	0.94	0.243	6.17	64.0	115.5
C0457A	3	16	19/0117	0.013	0.33	0.037	0.94	0.255	6.48	56.5	102.0
C0458A**	2	14	19/0147	0.013	0.33	0.042	1.07	0.288	7.32	72.5	131.0
C0459A**	3	14	19/0147	0.013	0.33	0.042	1.07	0.298	7.57	63.0	113.5
C0460A**	2	12	19/0185	0.013	0.33	0.042	1.07	0.315	8.00	80.5	145.0

*NEC Type PLTC Only
 **CSA or c(UL)
 Data subject to change.

COLOR CODE CHART

NO. OF COND.	COLOR
1	Black
2	Red
3	White



Multi-Conductor, Spiral Shield

UL 2095, NEC Type CL2, NEC/CEC Type CMG UL/CSA**



Product Construction:

Conductor:

- 22 thru 16 AWG fully annealed stranded tinned copper per ASTM B33

Insulation:

- Premium-grade, color-coded PVC
- Color code: See charts below

Shield:

- 85% spiral tinned copper

Jacket:

- PVC, gray
- Temperature range: -20°C to +105°C

Applications:

- Electronic circuits where RF shielding is required
- Radio transmitters
- Sound systems
- Recording studios
- Suggested voltage rating: 300 volts

Compliances:

- NEC Article 800 Type CM (UL: 105°C)
- UL Style 2095 (UL: 105°C, 300 V)
- CSA CMG (CSA: 105°C)
- RoHS Compliant Directive 2015/863/EU (RoHS-3)
- Passes CSA CMG Flame Test
- NEC Article 725 Type CL2 (UL: 105°C)

Packaging:

- Please contact Customer Service for packaging and color options

CATALOG NUMBER	NO. OF COND.	AWG SIZE	COND. STRAND	NOM. INSULATION THICKNESS		NOM. JACKET THICKNESS		NOMINAL O.D.		NOM. CAP.* pF/ft	
				in	mm	in	mm	in	mm	A	B

UL STYLE 2095, CM (UL) C(UL), CSA CMG, 300 V

C2882A	2	22	7/30	0.015	0.38	0.032	0.81	0.197	5.00	40.0	72.0
C2888A	2	20	7/28	0.016	0.41	0.032	0.81	0.215	5.46	44.0	80.2

Color Code Chart #1

CL2/CM (UL) C(UL), CSA CMG, 300 V

C1335A	3	22	7/30	0.015	0.38	0.032	0.81	0.206	5.23	37.0	67.0
C1337A	4	22	7/30	0.015	0.38	0.032	0.81	0.222	5.64	37.0	67.0
C1341A	6	22	7/30	0.015	0.38	0.032	0.81	0.257	6.53	34.5	62.0
C2768A	3	18	7/26	0.020	0.51	0.032	0.81	0.266	6.76	41.0	74.0

Color Code Chart #1

CM (UL) C(UL), CSA CMG, 300 V

C2892A	2	18	16/30	0.016	0.41	0.032	0.81	0.252	6.40	49.5	89.0
C2895A	2	16	19/0117	0.016	0.41	0.032	0.81	0.265	6.73	58.0	104.0

Color Code Chart #2

*A – Capacitance between conductors

*B – Capacitance between one conductor and other conductors connected to shield

**CSA or c(UL)

Data subject to change.

COLOR CODE CHART 1

NO. OF COND.	COLOR
1	Black
2	Red
3	White
4	Green
5	Yellow
6	Blue

COLOR CODE CHART 2

CATALOG NUMBER	CONDUCTOR	COLOR
C2892A	1	White
	2	Red
C2895A	1	White
	2	Black



Multi-Conductor, Braid Shield

NEC Type CL2 and CM(UL) c(UL)

Product Construction:

Conductor:

- 22 AWG fully annealed solid or stranded tinned copper per ASTM B33

Insulation:

- Premium-grade, color-coded PVC
- Color code: See chart below

Shield:

- 88% tinned copper braid
- Stranded or solid tinned copper drain wire

Jacket:

- PVC, black
- Temperature range: -20°C to +105°C

Applications:

- Electronic circuits where RF shielding is required
- Radio transmitters
- Sound systems
- Recording studios
- Good flexibility
- Excellent shielding for noise reduction
- Suggested voltage rating: 300 volts

Compliances:

- NEC Article 800 Type CM (UL: 105°C)
- RoHS Compliant Directive 2015/863/EU (RoHS-3)
- NEC Article 725 Type CL2 (UL: 105°C)

Packaging:

- Please contact Customer Service for packaging and color options

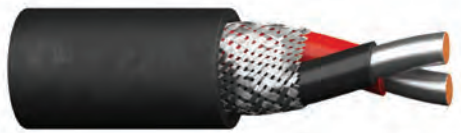

CATALOG NUMBER	NO. OF COND.	AWG SIZE	COND. STRAND	NOM. INSULATION THICKNESS		NOM. JACKET THICKNESS		NOMINAL O.D.		NOM. CAP.* pF/ft	
				in	mm	in	mm	in	mm	A	B
C2676A	2	22	Solid	0.015	0.38	0.032	0.81	0.209	5.31	38.6	69.4
C2677A	2	22	7/30	0.015	0.38	0.032	0.81	0.211	5.36	39.3	70.7

A - Capacitance between conductors
 *B - Capacitance between one conductor and other conductors connected to shield
 Data subject to change.

COLOR CODE CHART

NO. OF COND.	COLOR
1	Black
2	Red



Multi-Conductor, Braid Shield

UL 2092, 2093, 2094, NEC Type CM (UL) c(UL) CMH

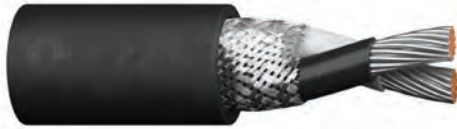

Product Construction:

Conductor:

- 20 AWG fully annealed stranded tinned copper per ASTM B33

Insulation:

- Premium-grade, color-coded polyethylene
- Color code: See chart below

Shield:

- 80% tinned copper braid
- Mylar wrap under braid

Jacket:

- PVC, gray
- Temperature range: -20°C to +75°C

Applications:

- Electronic circuits where RF shielding is required
- Video interconnect
- Broadcast and studio
- Sound systems
- Suggested voltage rating: 300 volts

Compliances:

- NEC Article 800 Type CM/CMH (UL: 75°C)
- AWM style 2092 (UL: 60°C, 300 V)
- AWM style 2093 (UL: 60°C, 300 V)
- AWM style 2094 (UL: 60°C, 300 V)
- RoHS Compliant Directive 2015/863/EU (RoHS-3)

Packaging:

- Please contact Customer Service for packaging and color options

CATALOG NUMBER	NO. OF COND.	AWG SIZE	COND. STRAND	NOM. INSULATION THICKNESS		NOM. JACKET THICKNESS		NOMINAL O.D.		NOM. CAP.*	
				in	mm	in	mm	in	mm	A	B

AWM STYLE 2092, CM (UL) C(UL) CMH, 300 V

C1642A	2	20	26/34	0.016	0.38	0.029	0.74	0.226	5.74	24.0	43.0
---------------	---	----	-------	-------	------	-------	------	-------	------	------	------

AWM STYLE 2093, CM (UL) C(UL) CMH, 300 V

C1643A	3	20	26/34	0.016	0.38	0.029	0.74	0.236	5.99	22.0	40.0
---------------	---	----	-------	-------	------	-------	------	-------	------	------	------

AWM STYLE 2094, CM (UL) C(UL) CMH 300 V

C1644A	4	20	26/34	0.016	0.38	0.029	0.74	0.255	6.48	22.0	39.0
C1645A	5	20	26/34	0.016	0.38	0.029	0.74	0.274	6.96	22.0	39.0
C1646A	6	20	26/34	0.016	0.38	0.029	0.74	0.290	7.37	20.0	36.0

*A – Capacitance between conductors

*B – Capacitance between one conductor and other conductors connected to shield
Data subject to change.

COLOR CODE CHART

NO. OF COND.	COLOR
1	Black
2	White
3	Red
4	Green
5	Yellow
6	Blue



Multi-Conductor, Braid Shield

UL 2095, NEC/CEC Type CMG UL/CSA**

Product Construction:

Conductor:

- 22 thru 16 AWG fully annealed stranded tinned copper per ASTM B33

Insulation:

- Premium-grade, color-coded PVC
- Color code: See chart below

Shield:

- 75% tinned copper braid

Jacket:

- PVC, gray
- Temperature range: -20°C to +105°C

Applications:

- Electronic circuits where RF shielding is required
- Radio transmitters
- Sound systems
- Recording studios
- Provides good flexibility
- Excellent shielding for noise reduction
- Suggested voltage rating: 300 volts

Compliances:

- NEC Article 800 Type CM (UL: 105°C)
- UL Style 2095 (UL: 105°C, 300 V)
- RoHS Compliant Directive 2015/863/EU (RoHS-3)
- CSA CMG (CSA: 105°C)
- Passes CSA CMG Flame Test

Packaging:

- Please contact Customer Service for packaging and color options

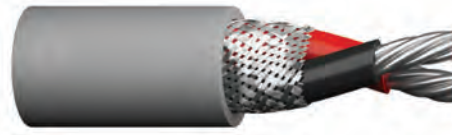

CATALOG NUMBER	NO. OF COND.	AWG SIZE	COND. STRAND	NOM. INSULATION THICKNESS		NOM. JACKET THICKNESS		NOMINAL O.D.		NOM. CAP.* pF/ft	
				in	mm	in	mm	in	mm	A	B
C2679A	2	22	7/30	0.016	0.41	0.032	0.81	0.212	5.38	40.0	72.0
C2678A	3	22	7/30	0.016	0.41	0.032	0.81	0.221	5.61	37.0	67.0
C2680A	4	22	7/30	0.016	0.41	0.032	0.81	0.237	6.02	37.0	67.0
C2681A	2	20	7/28	0.016	0.41	0.032	0.81	0.230	5.84	44.0	80.0
C1332A	3	20	7/28	0.016	0.41	0.032	0.81	0.240	6.10	40.0	72.0
C2683A	4	20	7/28	0.016	0.41	0.032	0.81	0.259	6.58	40.0	73.0
C2686A	2	18	16/30	0.016	0.41	0.032	0.81	0.252	6.40	49.0	89.0
C2687A	3	18	16/30	0.016	0.41	0.032	0.81	0.264	6.71	45.0	80.5
C2688A	4	18	16/30	0.016	0.41	0.032	0.81	0.286	7.26	45.0	80.5
C2689A	2	16	19/29	0.020	0.51	0.032	0.81	0.280	7.11	51.0	91.0

*A – Capacitance between conductors

*B – Capacitance between one conductor and other conductors connected to shield

**CSA or c(UL)

Data subject to change.

COLOR CODE CHART

NO. OF COND.	COLOR
1	Black
2	Red
3	White
4	Green



Multi-Conductor, Foil/Braid Shield

UL 2094, NEC Type CL2

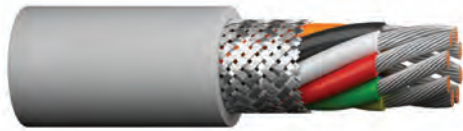

CATALOG NUMBER	NO. OF COND.	AWG SIZE	COND. STRAND	NOM. INSULATION THICKNESS		NOM. JACKET THICKNESS		NOMINAL O.D.		NOM. CAP.*	
				in	mm	in	mm	in	mm	A	B
C1648A	8	20	26/34	0.016	0.38	0.029	0.74	0.316	8.03	20.0	36.0

*A – Capacitance between conductors

*B – Capacitance between one conductor and other conductors connected to shield

Data subject to change.

COLOR CODE CHART

NO. OF COND.	COLOR	NO. OF COND.	COLOR
1	Black	5	Yellow
2	White	6	Blue
3	Red	7	Brown
4	Green	8	Orange

Product Construction:

Conductor:

- 20 AWG fully annealed stranded tinned copper per ASTM B33

Insulation:

- Premium-grade, color-coded polyethylene
- Color code: See chart below

Shield:

- 100% Flexfoil® aluminum/polyester, 25% overlap, foil facing out
- 80% tinned copper braid

Jacket:

- PVC, gray
- Temperature range: -20°C to +75°C

Applications:

- Electronic circuits where RF shielding is required
- Video interconnect
- Broadcast and studio
- Sound systems
- Suggested voltage rating: 300 volts

Compliances:

- NEC Article 725 Type CL2 (UL: 75°C)
- UL Style 2094 (UL: 60°C, 300 V)
- RoHS Compliant Directive 2015/863/EU (RoHS-3)

Packaging:

- Please contact Customer Service for packaging and color options

Multi-Conductor, Rubber, Unshielded

Product Construction:

Conductor:

- 20 AWG fully annealed stranded tinned copper per ASTM B33

Insulation:

- Premium-grade, color-coded rubber
- Color code: See chart below

Jacket:

- Rubber, black
- Temperature range: -20°C to +60°C

Applications:

- Energy management systems
- Control circuits
- Fire alarm control
- Broadcast and studio requirements
- Suggested voltage rating: 350 volts

Features:

- Excellent impact resistance
- High level of abrasion resistance
- High flexibility
- Excellent mechanical strength
- Excellent moisture resistance

Compliances:

- RoHS Compliant Directive 2015/863/EU (RoHS-3)

Packaging:

- Please contact Customer Service for packaging and color options



CATALOG NUMBER	NO. OF COND.	AWG SIZE	COND. STRAND	NOM. INSULATION THICKNESS		NOM. JACKET THICKNESS		NOMINAL O.D.	
				in	mm	in	mm	in	mm
C3602	2	20	26/34	0.020	0.51	0.035	0.89	0.016	0.406
C3603	3	20	26/34	0.020	0.51	0.035	0.89	0.016	0.406
C3604	4	20	26/34	0.020	0.51	0.035	0.89	0.016	0.406
C3605	5	20	26/34	0.020	0.51	0.035	0.89	0.016	0.406
C3606	6	20	26/34	0.020	0.51	0.035	0.89	0.016	0.406
C3607	7	20	26/34	0.020	0.51	0.035	0.89	0.016	0.406
C3608	8	20	26/34	0.020	0.51	0.035	0.89	0.016	0.406
C3610	10	20	26/34	0.020	0.51	0.035	0.89	0.016	0.406

Data subject to change.

COLOR CODE CHART

NO. OF COND.	COLOR	NO. OF COND.	COLOR	NO. OF COND.	COLOR	NO. OF COND.	COLOR
1	Black	4	Green	7	Yellow	10	Red/Black
2	White	5	Orange	8	Brown		
3	Red	6	Blue	9	White/Black		

Multi-Conductor, Rubber, Braid Shield



CATALOG NUMBER	NO. OF COND.	AWG SIZE	COND. STRAND	NOM. INSULATION THICKNESS		NOM. JACKET THICKNESS		NOMINAL O.D.	
				in	mm	in	mm	in	mm
C1302	2	20	26/34	0.020	0.51	0.035	0.89	0.270	6.86
C1304	3	20	26/34	0.020	0.51	0.035	0.89	0.285	7.24
C1305	4	20	26/34	0.020	0.51	0.035	0.89	0.300	7.62
C1310	6	20	26/34	0.020	0.51	0.035	0.89	0.340	8.64
C1312	7	20	26/34	0.020	0.51	0.035	0.89	0.355	9.02
C1313	8	20	26/34	0.020	0.51	0.035	0.89	0.385	9.78

Data subject to change.

COLOR CODE CHART

NO. OF COND.	COLOR	NO. OF COND.	COLOR
1	Black	5	Orange
2	White	6	Blue
3	Red	7	Yellow
4	Green	8	Brown

Product Construction:

Conductor:

- 20 AWG fully annealed stranded tinned copper per ASTM B33

Insulation:

- Premium-grade, color-coded rubber
- Color code: See chart below

Shield:

- 80% tinned copper braid

Jacket:

- Rubber, black
- Temperature range: -20°C to +60°C

Applications:

- Control circuits
- Broadcast and studio applications
- Audio interconnects
- Suggested voltage rating: 300 volts

Features:

- Impact- and abrasion-resistant
- Stranded conductors for superior flexibility

Compliances:

- RoHS Compliant Directive 2015/863/EU (RoHS-3)

Packaging:

- Please contact Customer Service for packaging and color options

Multi-Conductor, Carolprene[®], Braid Shield

Product Construction:

Conductor:

- 18 thru 14 AWG fully annealed stranded tinned copper per ASTM B33

Insulation:

- Premium-grade, color-coded rubber
- Color code: See chart below

Shield:

- 80% tinned copper braid

Jacket:

- Carolprene[®], black
- Temperature range: -20°C to +60°C

Applications:

- Control circuits
- Broadcast and studio applications
- Audio interconnects
- Suggested voltage rating: 300 volts

Features:

- Impact- and abrasion-resistant
- Stranded conductors for superior flexibility

Compliance:

- RoHS Compliant Directive 2015/863/EU (RoHS-3)

Packaging:

- Please contact Customer Service for packaging and color options

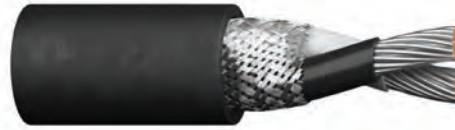

CATALOG NUMBER	NO. OF COND.	AWG SIZE	COND. STRAND	NOM. INSULATION THICKNESS		NOM. JACKET THICKNESS		NOMINAL O.D.	
				in	mm	in	mm	in	mm
C1202	2	18	41/34	0.020	0.51	0.035	0.89	0.295	7.49
C1203	3	18	41/34	0.020	0.51	0.035	0.89	0.305	7.75
C1206	6	18	41/34	0.020	0.51	0.035	0.89	0.370	9.39
C1602	2	16	65/34	0.025	0.64	0.035	0.89	0.335	8.51
C1603	3	16	65/34	0.025	0.64	0.035	0.89	0.355	9.02
C1604	4	16	65/34	0.025	0.64	0.035	0.89	0.385	9.78

Data subject to change.

COLOR CODE CHART

NO. OF COND.	COLOR
1	Black
2	White
3	Red
4	Green
5	Blue
6	Brown



Notes:

Communication & Control Cable, Multi-Paired **2**

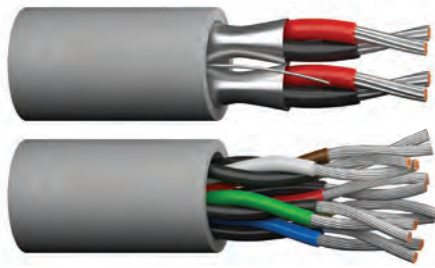

In many electronic applications, two wires are required to complete circuits; these are often referred to as “balanced arrays” or “twisted pair” constructions.

Paired cable designs find frequent application in circuits requiring circuit-to-circuit isolation from noise, minimization of capacitance imbalances and a reduction of EMI interference currents.

Circuit separation is further enhanced in those designs employing individual circuit shields in concert with an overall shield. These shielding systems are available from Prysmian in myriad combinations to suit the unique needs of the circuit designer.

As with the multi-conductor designs, a wide array of insulating and jacketing materials are available to meet specific electronic applications.

Prysmian’s CAROL® Brand communication cable products are manufactured to meet the latest UL, CSA and NEC requirements and approvals.

Index	Page
Multi-Paired, Unshielded	34-35
Multi-Paired, Foil Shield	36-39
Multi-Paired, Individually Shielded (UL)	40
Multi-Paired, Individually Shielded (CSA)	41
Power-Limited Tray Cable, Individually Shielded	42
Power-Limited Tray Cable, Foil Shield	43

Multi-Paired, Unshielded

UL 2464, NEC/CEC Type CMG UL/CSA**

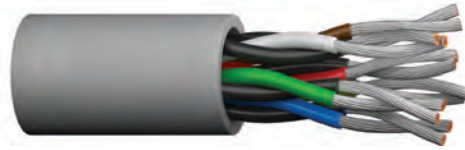

Product Construction:

Conductor:

- 22 AWG fully annealed solid or stranded tinned copper per ASTM B33
- Twisted pairs

Insulation:

- Premium-grade, color-coded PVC
- Color code: See chart below

Jacket:

- PVC, gray
- Temperature range: -20°C to +105°C

Applications:

- Computers
- Industrial equipment
- Data transmission
- Control circuits
- Suitable for EIA RS-232 applications
- Suggested voltage rating: 300 volts

Compliances:

- NEC Article 800 Type CM (UL: 105°C)
- UL Style 2464 (UL: 80°C, 300 V)
- CSA CMG (CSA: 105°C)
- RoHS Compliant Directive 2015/863/EU (RoHS-3)
- Passes CSA CMG Flame Test

Packaging:

- Please contact Customer Service for packaging and color options

CATALOG NUMBER	NO. OF PAIRS	AWG SIZE	COND. STRAND	NOM. INSULATION THICKNESS		NOM. JACKET THICKNESS		NOMINAL O.D.		NOM. C-C CAP.* pF/ft
				in	mm	in	mm	in	mm	
C4008A	1	22	Solid	0.010	0.25	0.032	0.81	0.156	3.94	24.5
C4010A	2	22	Solid	0.010	0.25	0.032	0.81	0.218	5.54	24.5
C4014A	3	22	Solid	0.010	0.25	0.032	0.81	0.229	5.82	24.5
C4015A	4	22	Solid	0.010	0.25	0.032	0.81	0.249	6.32	24.5
C4017A	6	22	Solid	0.010	0.30	0.032	0.81	0.288	7.44	24.5
C6010A	2	22	7/30	0.010	0.25	0.032	0.81	0.228	5.79	24.5
C6014A	3	22	7/30	0.010	0.25	0.032	0.81	0.240	6.10	24.5
C6015A	4	22	7/30	0.010	0.25	0.032	0.81	0.262	6.65	24.5
C6017A	6	22	7/30	0.010	0.25	0.032	0.81	0.300	7.62	24.5
C6019A	9	22	7/30	0.010	0.25	0.032	0.81	0.366	9.30	24.5
C6023A	12	22	7/30	0.010	0.25	0.032	0.81	0.410	10.40	24.5
C6026A	15	22	7/30	0.010	0.25	0.032	0.81	0.456	11.58	24.5

* Capacitance between conductors

**CSA or c(UL)

Data subject to change.

COLOR CODE CHART

NO. OF PAIRS	COLOR	NO. OF PAIRS	COLOR	NO. OF PAIRS	COLOR
1	Black paired with Red	6	Black paired with Brown	11	Red paired with Yellow
2	Black paired with White	7	Black paired with Orange	12	Red paired with Brown
3	Black paired with Green	8	Red paired with White	13	Red paired with Orange
4	Black paired with Blue	9	Red paired with Green	14	Green paired with White
5	Black paired with Yellow	10	Red paired with Blue	15	Green paired with Blue



Multi-Paired, Unshielded

UL 2464, NEC/CEC Type CMG UL/CSA**

Product Construction:

Conductor:

- 18 AWG fully annealed stranded tinned copper per ASTM B33
- Twisted pairs

Insulation:

- Premium-grade, color-coded PVC
- Color code: See chart below

Jacket:

- PVC, gray
- Temperature range: -20°C to +105°C

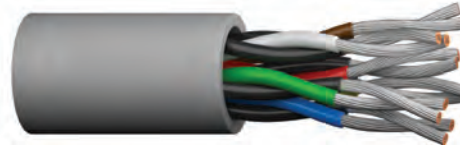

Applications:

- Computers
- Industrial equipment
- Data transmission
- Control circuits
- Suitable for EIA RS-232 applications
- Suggested voltage rating: 300 volts

Compliances:

- NEC Article 800 Type CM (UL: 105°C)
- UL Style 2464 (UL: 105°C, 300 V)
- CSA CMG (CSA: 105°C)
- RoHS Compliant Directive 2015/863/EU (RoHS-3)
- Passes CSA CMG Flame Test

Packaging:

- Please contact Customer Service for packaging and color options

CATALOG NUMBER	NO. OF PAIRS	AWG SIZE	COND. STRAND	NOM. INSULATION THICKNESS		NOM. JACKET THICKNESS		NOMINAL O.D.		NOM. C-C CAP.* pF/ft
				in	mm	in	mm	in	mm	
C6101A	1	18	16/30	0.013	0.33	0.032	0.81	0.206	5.23	26.3
C6118A	2	18	16/30	0.013	0.33	0.032	0.81	0.320	8.13	26.3
C6103A	3	18	16/30	0.013	0.33	0.032	0.81	0.338	8.59	26.3
C6119A	4	18	16/30	0.013	0.33	0.032	0.81	0.372	9.45	26.3
C6120A	5	18	16/30	0.013	0.33	0.032	0.81	0.408	10.36	26.3
C6106A	6	18	16/30	0.013	0.33	0.032	0.81	0.445	11.30	26.3
C6121A	8	18	16/30	0.013	0.33	0.032	0.81	0.484	12.29	26.3
C6109A	9	18	16/30	0.013	0.33	0.032	0.81	0.522	13.26	26.3
C6111A	15	18	16/30	0.013	0.33	0.032	0.81	0.659	16.74	26.3

*Capacitance between conductors

**CSA or c(UL)

Data subject to change.

COLOR CODE CHART

NO. OF PAIRS	COLOR	NO. OF PAIRS	COLOR	NO. OF PAIRS	COLOR
1	Black paired with Red	6	Black paired with Brown	11	Red paired with Yellow
2	Black paired with White	7	Black paired with Orange	12	Red paired with Brown
3	Black paired with Green	8	Red paired with White	13	Red paired with Orange
4	Black paired with Blue	9	Red paired with Green	14	Green paired with White
5	Black paired with Yellow	10	Red paired with Blue	15	Green paired with Blue



Multi-Paired, Foil Shield

NEC/CEC Type CMG UL/CSA**



Product Construction:

Conductor:

- 22 AWG fully annealed solid or stranded tinned copper per ASTM B33
- Twisted pairs

Insulation:

- Premium-grade, color-coded PVC
- Color code: See chart below

Shield:

- 100% Flexfoil® aluminum/polyester, 25% overlap, foil facing out
- Stranded tinned copper drain wire

Jacket:

- PVC, gray
- Temperature range: -20°C to +105°C

Applications:

- Audio systems
- Communication circuits
- Instrumentation and control use
- Suggested voltage rating: 300 volts

Compliances:

- NEC Article 800 Type CM (UL: 105°C, 300 V)
- CSA CMG (CSA: 105°C)
- RoHS Compliant Directive 2015/863/EU (RoHS-3)
- Passes CSA CMG Flame Test

Packaging:

- Please contact Customer Service for packaging and color options

CATALOG NUMBER	NO. OF PAIRS	AWG SIZE	COND. STRAND	NOM. INSULATION THICKNESS		NOM. JACKET THICKNESS		NOMINAL O.D.		NOMINAL CAP.* pF/ft	
				in	mm	in	mm	in	mm	A	B
C7104A †	1	22	7/0096	0.013	0.33	0.035	0.89	0.185	4.70	35.0	62.0
C1670A	2	22	Solid	0.010	0.25	0.032	0.81	0.218	5.54	32.0	57.0
C1676A	4	22	Solid	0.010	0.25	0.032	0.81	0.249	6.32	28.0	50.0
C1671A	6	22	Solid	0.010	0.25	0.032	0.81	0.292	7.42	25.0	45.0
C1672A	9	22	Solid	0.010	0.25	0.032	0.81	0.338	8.59	25.0	45.0
C1673A	15	22	Solid	0.010	0.25	0.032	0.81	0.419	10.64	25.0	45.0

*A – Capacitance between conductors

*B – Capacitance between one conductor and other conductors connected to shield

† Also UL Style 2464 (UL: 80°C, 300 V)

**CSA or c(UL)

Data subject to change.

COLOR CODE CHART

NO. OF PAIRS	COLOR	NO. OF PAIRS	COLOR	NO. OF PAIRS	COLOR
1	Black paired with Red	6	Black paired with Brown	11	Red paired with Yellow
2	Black paired with White	7	Black paired with Orange	12	Red paired with Brown
3	Black paired with Green	8	Red paired with White	13	Red paired with Orange
4	Black paired with Blue	9	Red paired with Green	14	Green paired with White
5	Black paired with Yellow	10	Red paired with Blue	15	Green paired with Blue



Multi-Paired, Foil Shield

NEC Type CMP (UL) c(UL)

Product Construction:

Conductor:

- 22 and 24 AWG fully annealed stranded tinned copper per ASTM B33
- Twisted pairs

Insulation:

- Premium-grade, color-coded fluoropolymer
- Color code: See chart below

Shield:

- 100% Flexfoil® aluminum/polyester foil with 25% overlap, minimum
- Stranded tinned copper drain wire

Jacket:

- Fluoropolymer, natural
- Water-resistant
- Temperature range: -40°C to +150°C
- Sequential footage marked to facilitate installation
- Includes ripcord

Applications:

- EIA RS-232 circuits
- Remote control circuits
- Process control and instrumentation
- Power-limited control circuits
- Suggested voltage rating: 300 volts

Compliances:

- NEC Article 800 (UL: 150°C, 300 V)
- Designed to meet NFPA 262 and CSA FT6 Steiner Tunnel Fire Tests for Plenum Applications

Packaging:

- Please contact Customer Service for packaging and color options



CATALOG NUMBER	NO. OF PAIRS	AWG SIZE	COND. STRAND	NOM. INSULATION THICKNESS		NOM. JACKET THICKNESS		NOMINAL O.D.		NOM. CAP.* pF/ft	
				in	mm	in	mm	in	mm	A	B
C3204	1	22	7/30	0.006	0.15	0.010	0.25	0.117	2.97	31.0	55.8
C3205	2	22	7/30	0.006	0.15	0.010	0.25	0.151	3.84	25.0	45.0
C3206	3	22	7/30	0.006	0.15	0.010	0.25	0.177	4.50	25.0	36.0
C3207	4	22	7/30	0.006	0.15	0.010	0.25	0.200	5.08	20.0	45.0
C3208	6	22	7/30	0.006	0.15	0.010	0.25	0.237	6.02	18.0	32.4
C3150	2	24	7/32	0.006	0.15	0.010	0.25	0.130	3.30	22.0	39.6
C3153	3	24	7/32	0.006	0.15	0.010	0.25	0.152	3.86	18.0	32.4
C3151	4	24	7/32	0.006	0.15	0.010	0.25	0.170	4.32	17.0	30.6
C3165	6	24	7/32	0.006	0.15	0.010	0.25	0.200	5.08	17.0	30.6
C3152	12.5	24	7/32	0.006	0.15	0.012	0.30	0.290	7.04	17.0	30.6

*A – Capacitance between conductors

*B – Capacitance between one conductor and other conductors connected to shield

Data subject to change.

COLOR CODE CHART

NO. OF PAIRS	COLOR	NO. OF PAIRS	COLOR	NO. OF PAIRS	COLOR
1	Black & Yellow	6	Tan & White	11	Gray/White & White/Gray
2	Red & Purple	7	Light Blue & Light Green	12	Blue/White & White/Blue
3	Dark Blue & Brown	8	Red/White & White/Red	1C	Dark Green/Yellow
4	Orange & Dark Green	9	Orange/White & White/Orange		
5	Pink & Gray	10	Yellow/White & White/Yellow		



Multi-Paired, Foil Shield

AWM Style 2464, CSA Type AWM I/II A/B, NEC/CEC Type CMG (CSA C/US)

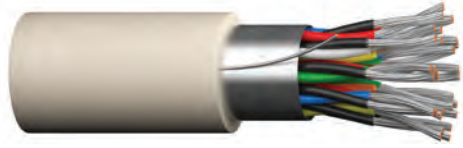

Product Construction:

Conductor:

- 24 AWG fully annealed stranded tinned copper per ASTM B33
- Twisted pairs

Insulation:

- Premium-grade, color-coded PVC
- Color code: See chart below

Shield:

- 100% Flexfoil® aluminum/polyester, 25% overlap, foil facing out
- Stranded tinned copper drain wire

Jacket:

- PVC, gray
- Temperature range: -20°C to +105°C

Applications:

- Computers
- Industrial equipment
- Data transmission
- Control circuits
- Suitable for EIA RS-232 applications
- Suggested voltage rating: 300 or 600 volts

Features:

- Excellent electrical properties
- Superior shielding effectiveness
- 25% shield overlap provides excellent shielding efficiency
- Assists system designers in meeting FCC Docket 20780 demands
- Good flexibility

Compliances:

- AWM Style 2464 (UL: 80°C, 300 V)
- CSA Type AWM (105°C, 600 V)
- CSA Certified CMG to harmonized standard UL 444 and CSA 22.2 No. 214
- NEC/CEC Type CMG (CSA: 105°C, 300 V)
- RoHS Compliant Directive 2015/863/EU (RoHS-3)
- Passes CSA FT4 Vertical Flame Test

Packaging:

- Please contact Customer Service for packaging and color options

CATALOG NUMBER	NO. OF PAIRS	AWG SIZE	COND. STRAND	NOM. INSULATION THICKNESS		NOM. JACKET THICKNESS		NOMINAL O.D.		NOMINAL DCR Ω/KFT		COLOR CODE	NOM. CAP.* pF/ft	
				in	mm	in	mm	in	mm	COND.	SHLD.		A	B
C4170A	1	24	7/32	0.011	0.28	0.032	0.81	0.160	4.06	26.0	18.0	1	36.4	65.5
C4209A	1	24	7/32	0.011	0.28	0.032	0.81	0.160	4.06	26.0	18.0	Wht/Blk	36.4	65.5
C4191A	1	24	7/32	0.011	0.28	0.030	0.76	0.160	4.06	26.0	16.5	Blk/Red	43.0	78.0
C4171A	2	24	7/32	0.011	0.28	0.032	0.81	0.214	5.44	26.0	18.0	1	31.9	57.3
C4172A	3	24	7/32	0.011	0.28	0.032	0.81	0.225	5.72	26.0	16.5	1	28.6	51.4
C4173A	4	24	7/32	0.011	0.28	0.032	0.81	0.245	6.22	26.0	16.5	1	28.6	51.4
C4174A	5	24	7/32	0.011	0.28	0.032	0.81	0.275	6.99	26.0	16.5	1	28.6	51.4
C4175A	6	24	7/32	0.011	0.28	0.032	0.81	0.300	7.62	26.0	15.2	1	26.3	47.5
C4176A	7	24	7/32	0.011	0.28	0.032	0.81	0.300	7.62	26.0	15.2	1	26.3	47.5
C4177A	8	24	7/32	0.011	0.28	0.032	0.81	0.320	8.13	26.0	15.0	1	26.3	47.5
C4178A	9	24	7/32	0.011	0.28	0.032	0.81	0.345	8.76	26.0	15.0	1	26.3	47.5
C4179A	10	24	7/32	0.011	0.28	0.032	0.81	0.375	9.53	26.0	14.0	1	26.3	47.5
C4180A	15	24	7/32	0.011	0.28	0.032	0.81	0.428	10.87	26.0	13.8	1	26.3	47.5
C4181A	19	24	7/32	0.011	0.28	0.032	0.81	0.450	11.43	26.0	13.5	1	26.3	47.5
C4182A	25	24	7/32	0.011	0.28	0.032	0.81	0.530	13.46	26.0	12.7	1	26.3	47.5

*A - Capacitance between conductors

*B - Capacitance between one conductor and other conductors connected to shield
Data subject to change.

COLOR CODE CHART 1

NO. OF COND.	COLOR	NO. OF COND.	COLOR	NO. OF COND.	COLOR	NO. OF COND.	COLOR	NO. OF COND.	COLOR
1	Black with Red	6	Black with Brown	11	Red with Yellow	16	Green with Yellow	21	White with Brown
2	Black with White	7	Black with Orange	12	Red with Brown	17	Green with Brown	22	White with Orange
3	Black with Green	8	Red with White	13	Red with Orange	18	Green with Orange	23	Blue with Yellow
4	Black with Blue	9	Red with Green	14	Green with White	19	White with Blue	24	Blue with Brown
5	Black with Yellow	10	Red with Blue	15	Green with Blue	20	White with Yellow	25	Blue with Orange



Multi-Paired, Foil Shield

AWM Style 2464, CSA Type AWM I/II A/B, NEC/CEC Type CMG (CSA C/US)

Product Construction:

Conductor:

- 22 AWG fully annealed stranded tinned copper per ASTM B33
- Twisted pairs

Insulation:

- Premium-grade, color-coded PVC
- Color code: See chart below

Shield:

- 100% Flexfoil® aluminum/polyester, 25% overlap, foil facing out
- Stranded tinned copper drain wire

Jacket:

- PVC, gray
- Temperature range: -20°C to +105°C

Applications:

- Computers
- Industrial equipment
- Data transmission
- Control circuits
- Suitable for EIA RS-232 applications
- Suggested voltage ratings: 300 or 600 volts

Features:

- Excellent electrical properties
- Superior shielding effectiveness
- 25% shield overlap provides excellent shielding efficiency
- Assists system designers in meeting FCC Docket 20780 demands
- Good flexibility

Compliances:

- AWM Style 2464 (UL: 80°C, 300 V)
- CSA Type AWM (105°C, 600 V)
- CSA Certified CMG to harmonized standard UL 444 and CSA 22.2 No. 214
- NEC/CEC Type CMG (CSA: 105°C, 300 V)
- RoHS Compliant Directive 2015/863/EU (RoHS-3)
- Passes CSA FT4 Vertical Flame Test

Packaging:

- Please contact Customer Service for packaging and color options



CATALOG NUMBER	NO. OF PAIRS	AWG SIZE	COND. STRAND	NOMINAL INSULATION THICKNESS		NOMINAL JACKET THICKNESS		NOMINAL O.D.		NOMINAL DCR Ω/kft		NOMINAL CAP.* pF/ft	
				in	mm	in	mm	in	mm	COND.	SHLD.	A	B
C4183A	1	22	7/30	0.011	0.28	0.032	0.81	0.169	4.29	15.0	18.0	44.8	80.7
C4184A	2	22	7/30	0.011	0.28	0.032	0.81	0.234	5.94	15.0	16.5	35.9	64.6
C4185A	3	22	7/30	0.011	0.28	0.032	0.81	0.246	6.25	15.0	16.5	30.9	55.7
C4186A	4	22	7/30	0.011	0.28	0.032	0.81	0.269	6.83	15.0	16.5	30.9	55.7
C4187A	5	22	7/30	0.011	0.28	0.032	0.81	0.294	7.47	15.0	16.5	30.9	55.7
C4188A	6	22	7/30	0.011	0.28	0.032	0.81	0.320	8.13	15.0	16.5	28.4	51.0
C4189A	9	22	7/30	0.011	0.28	0.032	0.81	0.367	9.32	15.0	16.5	28.4	51.0
C4190A	15	22	7/30	0.011	0.28	0.032	0.81	0.457	11.61	15.0	16.5	28.4	51.0

*A - Capacitance between conductors

*B - Capacitance between one conductor and other conductors connected to shield
Data subject to change.

COLOR CODE CHART 1

NO. OF PAIRS	COLOR	NO. OF PAIRS	COLOR	NO. OF PAIRS	COLOR
1	Black paired with Red	6	Black paired with Brown	11	Red paired with Yellow
2	Black paired with White	7	Black paired with Orange	12	Red paired with Brown
3	Black paired with Green	8	Red paired with White	13	Red paired with Orange
4	Black paired with Blue	9	Red paired with Green	14	Green paired with White
5	Black paired with Yellow	10	Red paired with Blue	15	Green paired with Blue

Multi-Paired, Individually Shielded

UL 2717, UL 2835, NEC Type CM (UL) c(UL) CMH or CMG



CATALOG NUMBER	NO. OF PAIRS	AWG SIZE	COND. STRAND	NOM. INSULATION THICKNESS		NOM. JACKET THICKNESS		NOMINAL O.D.		NOMINAL CAP.*	
				in	mm	in	mm	in	mm	A	B
POLYPROPYLENE INSULATION – NEC TYPE CM(UL) C(UL) CMH											
C1352A	2	22	7/30	0.007	0.18	0.020	0.51	0.160	4.06	30.0	45.0
POLYPROPYLENE INSULATION – UL STYLE 2717, UL STYLE 2835, CM(UL) C(UL) CMH											
C1353A**	2	22	7/30	0.010	0.25	0.028	0.71	0.208	5.028	25.0	53.5
105°C PVC INSULATION – UL STYLE 2464, CM(UL) C(UL) CMG											
C7106A	2	20	7/28	0.010	0.25	0.041	1.04	0.305	7.75	46.0	82.0

*A – Capacitance between conductors
 *B – Capacitance between one conductor and other conductors connected to shield
 **Individually shielded with overall shield
 Data subject to change.

COLOR CODE CHART

NO. OF PAIRS	COLOR
1	Black/Red
2	Green/White

Product Construction:

Conductor:

- 22 AWG fully annealed stranded tinned copper per ASTM B33
- Twisted pairs

Insulation:

- Premium-grade, color-coded polypropylene
- Color code: See chart below

Shield:

- Individually shielded pairs
- 100% Flexfoil® aluminum/polyester, 25% overlap, foil facing out
- Stranded tinned copper drain wire

Jacket:

- PVC, gray
- Temperature range: -20°C to +80°C

Applications:

- Where total isolation of signal is required
- Computers
- Control circuits
- Industrial equipment
- Suggested voltage rating: 300 volts

Compliances:

- NEC Article 800 Type CM (UL: 75°C, 300 V)
- UL Style 2717 (UL: 80°C)
- UL Style 2835 (UL: 60°C, 30 V)
- UL Style 2464 (UL: 80°C, 300 V)
- RoHS Compliant Directive 2015/863/EU (RoHS-3)
- Passes CSA CMH or CMG Flame Test

Packaging:

- Please contact Customer Service for packaging and color options

Multi-Paired, Individually Shielded

CSA Type AWM I/II A/B, NEC/CEC Type CMG (CSA C/US)

Product Construction:

Conductor:

- 22 AWG fully annealed stranded tinned copper per ASTM B33
- Twisted pairs

Insulation:

- Premium-grade, color-coded PVC
- Color code: See chart below

Shield:

- Individually shielded pairs
- 100% Flexfoil® aluminum/polyester, 25% overlap, foil facing out
- Stranded tinned copper drain wire

Jacket:

- PVC, gray
- Temperature range: -20°C to +105°C

Applications:

- Where total isolation of signal is required
- Computers
- Control circuits
- Industrial equipment
- Suggested voltage rating: 300 or 600 volts

Compliances:

- CSA Type AWM (105°C, 600 V)
- CSA Certified CMG to harmonized standard UL 444 and CSA (22.2 No. 2)
- NEC/CEC Type CMG (CSA: 105°C, 300 V)
- RoHS Compliant Directive 2015/863/EU (RoHS-3)
- Passes CSA FT4 Vertical Flame Test

Packaging:

- Please contact Customer Service for packaging and color options



CATALOG NUMBER	NO. OF PAIRS	AWG SIZE	COND. STRAND	NOMINAL INSULATION THICKNESS		NOMINAL JACKET THICKNESS		NOMINAL O.D.		NOMINAL DCR Ω/kft		NOMINAL CAP.* pF/ft	
				in	mm	in	mm	in	mm	COND.	SHLD.	A	B
C4203A	2	22	7/30	0.011	0.28	0.020	0.51	0.175	4.45	16.6	7.2	67.0	121.0

*A - Capacitance between conductors

*B - Capacitance between one conductor and other conductors connected to shield

Data subject to change.

COLOR CODE CHART

NO. OF PAIRS	COLOR
1	Black with Red
2	Green with White



Power-Limited Tray Cable, Individually Shielded

UL 2464, NEC Type PLTC and NEC/CEC Type CMG UL/CSA†



Product Construction:

Conductor:

- 22 or 18 AWG fully annealed stranded tinned copper per ASTM B33
- Twisted pairs

Insulation:

- Premium-grade, color-coded PVC
- Color code: Each pair black and red, numbered at one-inch intervals

Shield:

- Pairs are 100% individually shielded with Flexfoil® aluminum/polyester, foil facing in
- Stranded tinned copper drain wire each pair

Jacket:

- PVC, gray
- Sunlight-resistant
- Temperature range: -20°C to +105°C

Applications:

- Power-limited circuits
- Intercom systems
- Business machines
- Cash registers
- Computer interconnects
- Suitably marked for appropriate tray cable installations
- Burglar alarms
- Suggested voltage rating: 300 volts

Compliances:

- NEC Article 725 Power-Limited Tray Cable (UL: 105°C, 300 V)
- UL Style 2464 (UL: 80°C)
- CSA CMG (CSA: 105°C)
- RoHS Compliant Directive 2015/863/EU (RoHS-3)
- Passes CSA CMG Flame Test

Packaging:

- Please contact Customer Service for packaging and color options

CATALOG NUMBER	NO. OF PAIRS	AWG SIZE	COND. STRAND	NOM. INSULATION THICKNESS		NOM. JACKET THICKNESS		NOMINAL O.D.		NOMINAL CAP.* pF/ft	
				in	mm	in	mm	in	mm	A	B
C0570A	2	22	7/30	0.016	0.41	0.042	1.07	0.327	8.31	38.5	69.5
C0571A	3	22	7/30	0.016	0.41	0.042	1.07	0.345	8.76	38.5	69.5
C0572A	4	22	7/30	0.016	0.41	0.042	1.07	0.378	9.60	38.5	69.5
C0573A	6	22	7/30	0.016	0.41	0.053	1.35	0.469	11.91	38.5	69.5
C0574A	9	22	7/30	0.016	0.41	0.053	1.35	0.542	13.77	38.5	69.5
C0575A	11	22	7/30	0.016	0.41	0.053	1.35	0.589	14.96	38.5	69.5
C0584A	2	18	16/30	0.016	0.41	0.042	1.07	0.380	9.65	50.5	91.0
C0585A	3	18	16/30	0.016	0.41	0.053	1.35	0.437	11.10	50.5	91.0
C0586A	4	18	16/30	0.016	0.41	0.053	1.35	0.478	12.14	50.5	91.0
C0587A	6	18	16/30	0.016	0.41	0.053	1.35	0.566	14.38	50.5	91.0
C0588A	9	18	16/30	0.016	0.41	0.063	1.60	0.679	17.25	50.5	91.0
C0589A	11	18	16/30	0.016	0.41	0.063	1.60	0.738	18.75	50.5	91.0
C0590A	15	18	16/30	0.016	0.41	0.063	1.60	0.845	21.46	50.5	91.0

*A – Capacitance between conductors

*B – Capacitance between one conductor and other conductors connected to shield

†CSA or c(UL)

Data subject to change.

COLOR CODE CHART

NO. OF PAIRS	COLOR
1 thru 15	Black/Red

Each pair marked and numbered

Power-Limited Tray Cable, Foil Shield

UL 2464, NEC Type PLTC, NEC/CEC Type CM, CMG UL/CSA†

Product Construction:

Conductor:

- 22 or 18 AWG fully annealed stranded tinned copper per ASTM B33
- Twisted pairs

Insulation:

- Premium-grade, color-coded PVC or FMPE
- Color code: See chart below

Shield:

- 100% Flexfoil® aluminum/polyester, 25% overlap, foil facing out
- Stranded tinned copper drain wire
- 65% tinned copper braid (C7112A, C7114A and C7116A only)

Jacket:

- PVC, gray or black
- Sunlight-resistant
- Temperature range: -20°C to +60°C or +105°C

Applications:

- Power-limited circuits
- Intercom systems
- Business machines
- Computer interconnects
- Suitably marked for appropriate tray cable installations
- Petrochemical control systems
- Burglar alarms
- Suggested voltage rating: 300 volts

Compliances:

- NEC Article 725 Power-Limited Tray Cable (UL: 105°C or 60°C, 300 V)
- NEC Article 800 Communications Cable (UL: 105°C or 60°C, 300 V)
- †UL Style 2464 (UL: 80°C, 300 V)
- UL PLTC Listing
- CSA CMG (CSA: 60°C) or CM c(UL)
- RoHS Compliant Directive 2015/863/EU (RoHS-3)
- Passes CSA CMG Flame Test

Packaging:

- Please contact Customer Service for packaging and color options
- † UL Style 2464 only available on PVC insulation constructions



CATALOG NUMBER	NO. OF PAIRS	AWG SIZE	COND. STRAND	NOM. INSULATION THICKNESS		NOM. JACKET THICKNESS		NOMINAL O.D.		NOMINAL CAP.* pF/ft	
				in	mm	in	mm	in	mm	A	B

PVC INSULATION – UL STYLE 2464, NEC TYPE PLTC/CM, CSA CMG, 105°C

C0550A	2	22	7/0096	0.015	0.38	0.042	1.07	0.294	7.47	32.0	57.0
C0551A	3	22	7/0096	0.015	0.38	0.042	1.07	0.309	7.85	29.0	52.2
C0552A	4	22	7/0096	0.015	0.38	0.042	1.07	0.337	8.56	29.0	52.2
C0553A	6	22	7/0096	0.015	0.38	0.042	1.35	0.418	10.62	26.5	47.7
C0554A	9	22	7/0096	0.015	0.38	0.042	1.35	0.480	12.19	26.5	47.7
C0555A	11	22	7/30	0.015	0.38	0.053	1.35	0.520	13.21	27.0	48.5
C0556A	15	22	7/30	0.015	0.38	0.053	1.35	0.592	15.04	27.0	48.5
C0560A	2	18	16/30	0.016	0.41	0.042	1.07	0.314	7.98	40.0	72.0
C0561A	3	18	16/30	0.016	0.41	0.042	1.07	0.403	10.24	33.5	60.3
C0562A	4	18	16/30	0.016	0.41	0.042	1.07	0.440	11.18	33.5	60.3
C0563A	6	18	16/30	0.016	0.41	0.053	1.35	0.519	13.18	30.5	54.9
C0564A	9	18	16/30	0.016	0.41	0.063	1.60	0.643	16.33	30.5	54.9
C0566A	15	18	16/30	0.016	0.41	0.063	1.60	0.720	18.29	30.5	54.9

*A – Capacitance between conductors

*B – Capacitance between one conductor and other conductors connected to shield

†CSA or c(UL)

Data subject to change.

COLOR CODE CHART

NO. OF PAIRS	COLOR
1 thru 15	Black/Red

Each pair marked and numbered



LO-CAP® DATACOM COLOR CODE WITH 65% TINNED COPPER BRAID

CATALOG NUMBER	NO. OF PAIRS	AWG SIZE	COND. STRAND	NOM. INSULATION THICKNESS		NOM. JACKET THICKNESS		NOMINAL O.D.		NOMINAL CAP.* pF/ft	
				in	mm	in	mm	in	mm	A	B

FOAMED POLYETHYLENE INSULATION – NEC TYPE PLTC/CM, CEC CM c(UL), 60°C

C7112A	1	22	7/0096	0.024	0.61	0.037	0.94	0.261	6.63	11.5	20.5
C7114A	2	22	7/0096	0.017	0.43	0.042	1.07	0.343	8.71	11.0	19.6
C7116A	3	22	7/0096	0.015	0.38	0.042	1.07	0.344	8.74	11.0	19.6

*A – Capacitance between conductors

*B – Capacitance between one conductor and other conductors connected to shield

Data subject to change.

COLOR CODE CHART

NO. OF PAIRS	COLOR
1	White/Blue Stripe and Blue/White Stripe
2	White/Orange Stripe and Orange/White Stripe
3	White/Green Stripe and Green/White Stripe



Underwriters Laboratories Inc.



Computer Cable

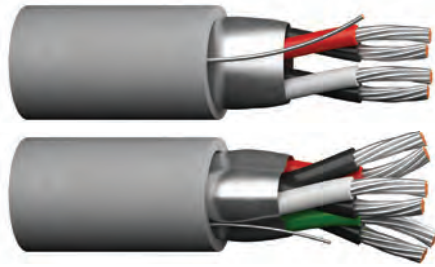

Prysmian manufactures a comprehensive line of computer cables.

This complete line of paired and unpaired, shielded computer cables—which are UL and CSA listed—are used primarily for the internal or external interconnection of electronic equipment and computers. Applications include data transmission, CAD/CAM, telemetry, data displays, computer print-out, credit verification systems and similar applications.

Prysmian also offers a variety of put-ups for computer cables to meet your individual requirements.

Our products are manufactured to meet the latest UL, CSA and NEC requirements and approvals.

Section	Page
Multi-Conductor, Foil Shield	45-46
Multi-Conductor, Foil/Braid Shield	47-48
Multi-Conductor, Foil/Braid Shield, Lo-Cap®	49
Multi-Paired, Foil Shield	50
Multi-Paired, Foil Shield, Lo-Cap	51
Multi-Paired, Foil/Braid Shield	52
Multi-Paired, Foil/Braid Shield, Lo-Cap	53-55
Multi-Paired, Individually Foil Shielded	56
Multi-Paired, Individually Foil Shielded, Lo-Cap	57
Multi-Paired, Individually Foil/Braid Shielded, Lo-Cap	58

Multi-Conductor, Foil Shield

UL 2464, NEC/CEC Type CMR, CMG UL/CSA

Product Construction:

Conductor:

- 24 AWG fully annealed stranded tinned copper per ASTM B33

Insulation:

- Premium-grade, color-coded PVC
- Color code: See charts below

Shield:

- 100% Flexfoil® aluminum/polyester with 25% overlap, foil facing out
- Stranded tinned copper drain wire

Jacket:

- PVC, gray
- Temperature range: -20°C to +105°C

Applications:

- Computer interconnections
- Data transmission
- Control circuits
- Industrial equipment control
- Suitable for EIA RS-232 applications
- Suggested voltage rating: 300 volts

Compliances:

- NEC Article 800 Type CMR (UL: 105°C)
- UL Style 2464 (UL: 105°C, 300 V)
- CSA CMG (CSA: 105°C)
- RoHS Compliant Directive 2015/863/EU (RoHS-3)
- Passes CSA CMG Flame Test

Packaging:

- Please contact Customer Service for packaging and color options
- Data subject to change.



CATALOG NUMBER	NO. OF COND.	AWG SIZE	COND. STRAND	NOMINAL INSULATION THICKNESS		NOMINAL JACKET THICKNESS		NOMINAL O.D.		NOMINAL DCR Ω/ft @20°C		NOMINAL CAP.* pF/ft	
				in	mm	in	mm	in	mm	COND.	SHLD.	A	B
C0740A	2	24	7/32	0.010	0.25	0.032	0.81	0.157	3.99	26.0	7.2	36.0	64.0
C0741A	3	24	7/32	0.010	0.25	0.032	0.81	0.164	4.17	26.0	7.2	33.0	59.0
C0742A	4	24	7/32	0.010	0.25	0.032	0.81	0.175	4.45	26.0	7.2	33.0	59.0
C0753A	5	24	7/32	0.010	0.25	0.032	0.81	0.188	4.78	26.0	7.2	33.0	59.0
C0743A	6	24	7/32	0.010	0.25	0.032	0.81	0.201	5.11	26.0	7.2	30.0	55.0
C0754A	7	24	7/32	0.010	0.25	0.032	0.81	0.201	5.11	26.0	7.2	30.0	55.0
C0744A	8	24	7/32	0.010	0.25	0.032	0.81	0.215	5.46	26.0	7.2	30.0	55.0
C0755A	9	24	7/32	0.010	0.25	0.032	0.81	0.228	5.79	26.0	7.2	30.0	55.0
C0745A	10	24	7/32	0.010	0.25	0.032	0.81	0.245	6.22	26.0	7.2	30.0	55.0

*A – Capacitance between conductors

*B – Capacitance between one conductor and other conductors connected to shield

COLOR CODE CHART 1

For cables up to and including 10 conductors

NO. OF COND.	COLOR	NO. OF COND.	COLOR	NO. OF COND.	COLOR
1	Black	5	Light Brown	9	Purple
2	White	6	Light Blue	10	Gray
3	Red	7	Orange		
4	Light Green	8	Yellow		

CATALOG NUMBER	NO. OF COND.	AWG SIZE	COND. STRAND	NOMINAL INSULATION THICKNESS		NOMINAL JACKET THICKNESS		NOMINAL O.D.		NOMINAL DCR Ω/ft @20°C		NOMINAL CAP.* pF/ft	
				in	mm	in	mm	in	mm	COND.	SHLD.	A	B
C0746A	15	24	7/32	0.010	0.25	0.032	0.81	0.276	7.01	26.0	7.2	30.0	55.0
C0747A	20	24	7/32	0.010	0.25	0.032	0.81	0.303	7.70	26.0	7.2	30.0	55.0
C0748A	25	24	7/32	0.010	0.25	0.032	0.81	0.333	8.46	26.0	7.2	30.0	55.0
C0749A	30	24	7/32	0.010	0.25	0.032	0.81	0.351	8.92	26.0	7.2	30.0	55.0
C0750A	40	24	7/32	0.010	0.25	0.032	0.81	0.391	9.93	26.0	7.2	30.0	55.0
C0751A	50	24	7/32	0.010	0.25	0.032	0.81	0.439	11.15	26.0	7.2	30.0	55.0

*A – Capacitance between conductors

*B – Capacitance between one conductor and other conductors connected to shield

COLOR CODE CHART 2 PER ICEA

For cables of 15 thru 50 conductors

NO. OF COND.	COLOR	NO. OF COND.	COLOR	NO. OF COND.	COLOR	NO. OF COND.	COLOR	NO. OF COND.	COLOR
1	Black	11	Light Blue/Black	21	Orange/Green	31	Light Green/Black/Orange	41	Light Green/White/Blue
2	White	12	Black/White	22	Black/White/Red	32	Orange/Black/Green	42	Orange/Red/Green
3	Red	13	Red/White	23	White/Black/Red	33	Light Blue/White/Orange	43	Light Blue/Red/Green
4	Light Green	14	Light Green/White	24	Red/Black/White	34	Black/White/Orange	44	Black/White/Blue
5	Orange	15	Light Blue/White	25	Light Green/Black/White	35	White/Red/Orange	45	White/Black/Blue
6	Light Blue	16	Black/Red	26	Orange/Black/White	36	Orange/White/Blue	46	Red/White/Blue
7	White/Black	17	White/Red	27	Light Blue/Black/White	37	White/Red/Blue	47	Light Green/Orange/Red
8	Red/Black	18	Orange/Red	28	Black/Red/Green	38	Black/White/Green	48	Orange/Red/Blue
9	Light Green/Black	19	Light Blue/Red	29	White/Red/Green	39	White/Black/Green	49	Light Blue/Red/Orange
10	Orange/Black	20	Red/Green	30	Red/Black/Green	40	Red/White/Green	50	Black/Orange/Red



Multi-Conductor, Foil Shield

UL 2464, NEC/CEC Type CM or CMR, CMG UL/CSA



Product Construction:

Conductor:

- 22 or 20 AWG fully annealed stranded tinned copper per ASTM B33

Insulation:

- Premium-grade, color-coded PVC
- Color code: See chart below

Shield:

- 100% Flexfoil® aluminum/polyester with 25% overlap, minimum, foil facing out
- Stranded tinned copper drain wire

Jacket:

- PVC, gray
- Temperature range: -20°C to +105°C

Applications:

- Computer interconnections
- Data transmission
- Control circuits
- Industrial equipment control
- Suitable for EIA RS-232 applications
- Suggested voltage rating: 300 volts

Compliances:

- NEC Article 800 Type CM - 20 AWG (UL: 105°C)
- NEC Article 800 Type CMR - 20 AWG (UL: 105°C)
- UL Style 2464 (UL: 80°C, 300 V)
- CSA CMG (CSA: 105°C)
- RoHS Compliant Directive 2015/863/EU (RoHS-3)
- Passes CSA CMG Flame Test

Packaging:

- Please contact Customer Service for packaging and color options

CATALOG NUMBER	NO. OF COND.	AWG SIZE	COND. STRAND	NOMINAL INSULATION THICKNESS		NOMINAL JACKET THICKNESS		NOMINAL O.D.		NOMINAL DCR Ω /kft @20°C		NOMINAL CAP.* pF/ft	
				in	mm	in	mm	in	mm	COND.	SHLD.	A	B

PVC - CMR (UL) c(UL)

C0760A	2	22	7/30	0.010	0.25	0.032	0.81	0.169	4.29	16.5	6.3	36.0	65.0
C0761A	3	22	7/30	0.010	0.25	0.032	0.81	0.177	4.50	16.5	6.3	36.0	65.0
C0762A	4	22	7/30	0.010	0.25	0.032	0.81	0.190	4.83	16.5	6.3	36.0	65.0
C0763A	6	22	7/30	0.010	0.25	0.032	0.81	0.219	5.56	16.5	6.3	34.0	61.0
C0764A	8	22	7/30	0.010	0.25	0.032	0.81	0.235	5.97	16.5	6.3	34.0	61.0
C0765A	10	22	7/30	0.010	0.25	0.032	0.81	0.269	6.83	16.5	6.3	34.0	61.0
C0766A	15	22	7/30	0.010	0.25	0.032	0.81	0.304	7.72	16.5	6.3	34.0	61.0
C0767A	20	22	7/30	0.010	0.25	0.032	0.81	0.335	8.51	16.5	6.3	34.0	61.0
C0768A	25	22	7/30	0.010	0.25	0.032	0.81	0.369	9.37	16.5	6.3	34.0	61.0

PVC - CM (UL) c(UL)

C0780A	2	20	7/28	0.016	0.41	0.032	0.81	0.207	5.26	11.0	6.3	39.0	70.0
C0781A	3	20	7/28	0.016	0.41	0.032	0.81	0.217	5.51	11.0	6.3	39.0	70.0
C0782A	4	20	7/28	0.016	0.41	0.032	0.81	0.236	5.99	11.0	6.3	39.0	70.0
C0783A	6	20	7/28	0.016	0.41	0.032	0.81	0.276	7.01	11.0	6.3	37.0	66.0
C0784A	8	20	7/28	0.016	0.41	0.032	0.81	0.297	7.54	11.0	6.3	37.0	66.0
C0785A	10	20	7/28	0.016	0.41	0.032	0.81	0.345	8.76	11.0	6.3	37.0	66.0
C0786A	15	20	7/28	0.016	0.41	0.032	0.81	0.393	9.98	11.0	6.3	37.0	66.0
C0787A	20	20	7/28	0.016	0.41	0.032	0.81	0.435	11.05	11.0	6.3	37.0	66.0
C0788A	25	20	7/28	0.016	0.41	0.032	0.81	0.483	12.27	11.0	6.3	40.0	72.0

*A - Capacitance between conductors

*B - Capacitance between one conductor and other conductors connected to shield

Data subject to change.

COLOR CODE CHART

NO. OF COND.	COLOR	NO. OF COND.	COLOR	NO. OF COND.	COLOR	NO. OF COND.	COLOR	NO. OF COND.	COLOR
1	Black	6	Blue	11	Blue/Black	16	Black/Red	21	Orange/Green
2	White	7	White/Black	12	Black/White	17	White/Red	22	Black/White/Red
3	Red	8	Red/Black	13	Red/White	18	Orange/Red	23	White/Black/Red
4	Green	9	Green/Black	14	Green/White	19	Blue/Red	24	Red/Black/White
5	Orange	10	Orange/Black	15	Blue/White	20	Red/Green	25	Green/Black/White



Multi-Conductor, Foil/Braid Shield

UL 2464, NEC Type CL2 or NEC/CEC Type CM, CMG UL/CSA

Product Construction:

Conductor:

- 28 and 24 AWG fully annealed stranded tinned copper per ASTM B33

Insulation:

- Premium-grade, color-coded PVC
- Color code: See charts below

Shield:

- 100% Flexfoil® aluminum/polyester with 25% overlap, minimum, foil facing out
- Stranded tinned copper drain wire
- 65% tinned copper braid

Jacket:

- PVC, gray
- Temperature range: -20°C to +105°C

Applications:

- Computers
- Industrial equipment
- Data transmission
- Control circuits
- Suitable for EIA RS-232 applications
- Suggested voltage rating: 300 volts

Compliances:

- NEC Article 800 Type CM - 24 AWG (UL: 105°C)
- UL Style 2464 (UL: 80°C, 300 V)
- CSA CMG (CSA: 105°C)
- RoHS Compliant Directive 2015/863/EU (RoHS-3)
- Passes CSA CMG Flame Test

Packaging:

- Please contact Customer Service for packaging and color options

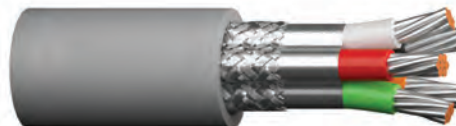

CATALOG NUMBER	NO. OF COND.	AWG SIZE	COND. STRAND	NOMINAL INSULATION THICKNESS		NOMINAL JACKET THICKNESS		NOMINAL O.D.		NOMINAL DCR Ω/kft @20°C		NOMINAL CAP.** pF/ft	
				in	mm	in	mm	in	mm	COND.	SHLD.	A	B
CM, CMG, UL 2464													
C0951A	3	24	7/32	0.010	0.25	0.032	0.81	0.186	4.72	25.7	5.3	33.0	59.0
C0952A	4	24	7/32	0.010	0.25	0.032	0.81	0.197	5.00	25.7	5.5	33.0	59.0
C0953A	5	24	7/32	0.010	0.25	0.032	0.81	0.210	5.33	25.7	4.4	33.0	59.0
C0954A	6	24	7/32	0.010	0.25	0.032	0.81	0.223	5.66	25.7	4.6	30.0	55.0
C0955A	7	24	7/32	0.010	0.25	0.032	0.81	0.223	5.66	25.7	4.6	30.0	55.0
C0956A	8	24	7/32	0.010	0.25	0.032	0.81	0.237	6.02	25.7	3.8	30.0	55.0
C0957A	9	24	7/32	0.010	0.25	0.032	0.81	0.250	6.35	25.7	3.9	30.0	55.0
C0958A	10	24	7/32	0.010	0.25	0.032	0.81	0.267	6.78	25.7	4.2	30.0	55.0
C0959A	15	24	7/32	0.010	0.25	0.032	0.81	0.298	7.57	25.7	3.6	30.0	55.0
C0960A	20	24	7/32	0.010	0.25	0.032	0.81	0.325	8.26	25.7	4.5	30.0	55.0
C0961A	25	24	7/32	0.010	0.25	0.032	0.81	0.355	9.02	25.7	3.5	30.0	55.0

*Color Code Chart 1. Remaining items Color Code Chart 2
 **A - Capacitance between conductors
 **B - Capacitance between one conductor and other conductors connected to shield
 Data subject to change.

COLOR CODE CHART 1

For cables up to and including 10 conductors

NO. OF COND.	COLOR	NO. OF COND.	COLOR	NO. OF COND.	COLOR
1	Black	5	Light Brown	9	Purple
2	White	6	Light Blue	10	Gray
3	Red	7	Orange		
4	Light Green	8	Yellow		

COLOR CODE CHART 2 Per ICEA

NO. OF COND.	COLOR	NO. OF COND.	COLOR	NO. OF COND.	COLOR	NO. OF COND.	COLOR	NO. OF COND.	COLOR
1	Black	6	Light Blue	11	Light Blue/Black	16	Black/Red	21	Orange/Green
2	White	7	White/Black	12	Black/White	17	White/Red	22	Black/White/Red
3	Red	8	Red/Black	13	Red/White	18	Orange/Red	23	White/Black/Red
4	Light Green	9	Light Green/Black	14	Light Green/White	19	Light Blue/Red	24	Red/Black/White
5	Orange	10	Orange/Black	15	Light Blue/White	20	Red/Green	25	Light Green/Black/White



Multi-Conductor, Foil/Braid Shield

UL 2464, NEC/CEC Type CMR, CMG UL/CSA



Product Construction:

Conductor:

- 22 AWG fully annealed stranded tinned copper per ASTM B33

Insulation:

- Premium-grade, color-coded PVC
- Color code: See chart below

Shield:

- 100% Flexfoil® aluminum/polyester with 25% overlap, minimum, foil facing out
- 65% tinned copper braid

Jacket:

- PVC, gray
- Temperature range: -20°C to +105°C

Applications:

- Computers
- Industrial equipment
- Data transmission
- Control circuits
- Suitable for EIA RS-232 applications
- Suggested voltage rating: 300 volts

Compliances:

- NEC Article 800 Type CMR (UL: 105°C)
- UL Style 2464 (UL: 80°C, 300 V)
- CSA CMG (CSA: 105°C)
- RoHS Compliant Directive 2015/863/EU (RoHS-3)
- Passes CSA CMG Flame Test

Packaging:

- Please contact Customer Service for packaging and color options

CATALOG NUMBER	NO. OF COND.	AWG SIZE	COND. STRAND	NOMINAL INSULATION THICKNESS		NOMINAL JACKET THICKNESS		NOMINAL O.D.		NOMINAL DCR @/kft @20°C		NOMINAL CAP.* pF/ft	
				in	mm	in	mm	in	mm	COND.	SHLD.	A	B
C0971A	3	22	7/30	0.010	0.25	0.032	0.81	0.199	5.05	16.6	5.6	36.0	66.0
C0972A	4	22	7/30	0.010	0.25	0.032	0.81	0.212	5.38	16.6	4.4	36.0	66.0
C0973A	5	22	7/30	0.010	0.25	0.032	0.81	0.226	5.74	16.6	4.7	36.0	66.0
C0974A	6	22	7/30	0.010	0.25	0.032	0.81	0.241	6.12	16.6	3.8	34.0	60.0
C0975A	7	22	7/30	0.010	0.25	0.032	0.81	0.241	6.12	16.6	6.2	34.0	60.0
C0976A	8	22	7/30	0.010	0.25	0.032	0.81	0.257	6.53	16.6	4.0	34.0	60.0
C0977A	9	22	7/30	0.010	0.25	0.032	0.81	0.272	6.91	16.6	3.4	34.0	60.0
C0978A	10	22	7/30	0.010	0.25	0.032	0.81	0.291	7.39	16.6	3.6	34.0	60.0
C0979A	15	22	7/30	0.010	0.25	0.032	0.81	0.326	8.28	16.6	3.6	34.0	60.0
C0980A	20	22	7/30	0.010	0.25	0.032	0.81	0.357	9.07	16.6	3.9	34.0	60.0
C0981A	25	22	7/30	0.010	0.25	0.032	0.81	0.391	9.93	16.6	2.7	34.0	60.0

*A – Capacitance between conductors

*B – Capacitance between one conductor and other conductors connected to shield
Data subject to change.

COLOR CODE CHART Per ICEA

NO. OF COND.	COLOR	NO. OF COND.	COLOR	NO. OF COND.	COLOR	NO. OF COND.	COLOR	NO. OF COND.	COLOR
1	Black	6	Light Blue	11	Light Blue/Black	16	Black/Red	21	Orange/Green
2	White	7	White/Black	12	Black/White	17	White/Red	22	Black/White/Red
3	Red	8	Red/Black	13	Red/White	18	Orange/Red	23	White/Black/Red
4	Light Green	9	Light Green/Black	14	Light Green/White	19	Light Blue/Red	24	Red/Black/White
5	Orange	10	Orange/Black	15	Light Blue/White	20	Red/Green	25	Light Green/Black/White



Multi-Conductor, Foil/Braid Shield, Lo-Cap®

UL 2919, NEC Type CL2 or NEC/CEC Type CM, CEC Type CMH UL/CSA

Product Construction:

Conductor:

- 24 AWG fully annealed stranded tinned copper per ASTM B33

Insulation:

- Premium grade foamed Lo-Cap® color coded polypropylene
- Color code: See chart below

Shield:

- 100% Flexfoil® aluminum/polyester with 25% overlap, minimum, foil facing out
- Stranded tinned copper drain wire
- 70% tinned copper braid

Jacket:

- PVC, gray
- Temperature range: -20°C to +80°C

Applications:

- High speed computers
- Industrial equipment
- Control circuits
- Designed for low capacitance applications
- Suitable for EIA RS-232 and RS-423 CAD/CAM applications
- Suggested voltage rating: 30 volts

Compliances:

- NEC Article 800 Type CM (UL: 75°C, 300 V)
- UL Style 2919 (UL: 80°C, 30 V)
- CSA CMH (CSA: 60°C)
- RoHS Compliant Directive 2015/863/EU (RoHS-3)
- Passes CSA CMH Flame Test

Packaging:

- Please contact Customer Service for packaging and color options



CATALOG NUMBER	NO. OF COND.	NOM. INSULATION THICKNESS		NOM. JACKET THICKNESS		NOMINAL O.D.		NOMINAL DCR Ω/kft		NOMINAL CAP.* pF/ft	
		in	mm	in	mm	in	mm	COND.	SHLD.	A	B
24 AWG (7/32): CM (UL) c(UL) CMH, AWM Style 2919											
C0680A	3	0.016	0.41	0.032	0.81	0.211	5.36	25.7	3.8	11.9	21.5
C0681A	4	0.016	0.41	0.032	0.81	0.227	5.77	25.7	3.8	11.9	21.5
C0682A	5	0.016	0.41	0.032	0.81	0.242	6.15	25.7	3.8	11.9	21.5
C0683A	6	0.016	0.41	0.032	0.81	0.259	6.58	25.7	3.2	11.2	20.2
C0684A	7	0.016	0.41	0.032	0.81	0.259	6.58	25.7	3.2	11.2	20.2
C0685A	8	0.016	0.41	0.032	0.81	0.276	7.01	25.7	3.2	11.2	20.2
C0686A	9	0.016	0.41	0.032	0.81	0.293	7.44	25.7	3.6	11.2	20.2
C0687A	10	0.016	0.41	0.032	0.81	0.315	8.00	25.7	3.6	11.2	20.2
C0688A	15	0.016	0.41	0.032	0.81	0.354	8.99	25.7	3.6	11.2	20.2

*A – Capacitance between conductors
 *B – Capacitance between one conductor and other conductors connected to shield
 Vp = 78%
 Impedance: ≈100 Ω
 Data subject to change.

COLOR CODE CHART 1

For cables up to and including 10 conductors

NO. OF COND.	COLOR	NO. OF COND.	COLOR	NO. OF COND.	COLOR
1	Black	5	Brown	9	Purple
2	White	6	Light Blue	10	Gray
3	Red	7	Orange		
4	Light Green	8	Yellow		

COLOR CODE CHART 2 PER ICEA

For cables up to 15 conductors

NO. OF COND.	COLOR	NO. OF COND.	COLOR	NO. OF COND.	COLOR
1	Black	6	Light Blue	11	Light Blue/Black
2	White	7	White/Black	12	Black/White
3	Red	8	Red/Black	13	Red/White
4	Light Green	9	Light Green/Black	14	Light Green/White
5	Orange	10	Orange/Black	15	Light Blue/White



Multi-Paired, Foil Shield

UL 2464, NEC/CEC Type CMR, CMG UL/CSA



Product Construction:

Conductor:

- 24 AWG fully annealed stranded tinned copper per ASTM B33
- Twisted pairs

Insulation:

- Premium-grade, color-coded PVC
- Color code: See chart below

Shield:

- 100% Flexfoil® aluminum/polyester with 25% overlap, minimum, foil facing out
- Stranded tinned copper drain wire

Jacket:

- PVC, gray
- Temperature range: -20°C to +105°C

Applications:

- Computers
- Industrial equipment
- Data transmission
- Control circuits
- Suitable for EIA RS-232 applications
- Suggested voltage rating: 300 volts

Compliances:

- NEC Article 800 Type CMR (UL: 105°C)
- UL Style 2464 (UL: 80°C, 300 V)
- CSA CMG (CSA, 105°C)
- RoHS Compliant Directive 2015/863/EU (RoHS-3)
- Passes CSA CMG Flame Test

Packaging:

- Please contact Customer Service for packaging and color options
- Data subject to change.

CATALOG NUMBER	NO. OF PAIRS	AWG SIZE	COND. STRAND	NOMINAL INSULATION THICKNESS		NOMINAL JACKET THICKNESS		NOMINAL O.D.		NOMINAL DCR Ω/kft		NOMINAL CAP.* pF/ft	
				in	mm	in	mm	in	mm	COND.	SHLD.	A	B
C0600A	1	24	7/32	0.010	0.25	0.032	0.81	0.157	3.99	25.7	7.2	19.7	21.5
C0601A	2	24	7/32	0.010	0.25	0.032	0.81	0.214	5.44	25.7	7.2	28.7	21.5
C0602A	3	24	7/32	0.010	0.25	0.032	0.81	0.225	5.72	25.7	7.2	25.7	21.5
C0603A	4	24	7/32	0.010	0.25	0.032	0.81	0.245	6.23	25.7	7.2	25.7	20.2
C0604A	5	24	7/32	0.010	0.25	0.032	0.81	0.265	6.73	25.7	7.2	25.7	20.2
C0605A	6	24	7/32	0.010	0.25	0.032	0.81	0.287	7.29	25.7	7.2	23.7	42.7
C0606A	7	24	7/32	0.010	0.25	0.032	0.81	0.287	7.29	25.7	7.2	23.7	42.7
C0607A	8	24	7/32	0.010	0.25	0.032	0.81	0.309	7.85	25.7	7.2	23.7	42.7
C0608A	9	24	7/32	0.010	0.25	0.032	0.81	0.331	8.41	25.7	7.2	23.7	42.7
C0609A	10	24	7/32	0.010	0.25	0.032	0.81	0.359	9.12	25.7	7.2	23.7	42.7
C0610A	15	24	7/32	0.010	0.25	0.032	0.81	0.410	10.41	25.7	7.2	23.7	42.7
C0611A	19	24	7/32	0.010	0.25	0.032	0.81	0.432	10.97	25.7	7.2	23.7	42.7
C0612A	25	24	7/32	0.010	0.25	0.032	0.81	0.505	12.84	25.7	7.2	23.7	42.7
C0720A	1	22	7/30	0.010	0.25	0.032	0.81	0.169	4.29	16.6	6.2	40.4	72.6
C0721A	2	22	7/30	0.010	0.25	0.032	0.81	0.234	5.94	16.6	6.2	32.3	58.1
C0722A	3	22	7/30	0.010	0.25	0.032	0.81	0.246	6.25	16.6	6.2	27.8	50.1
C0723A	4	22	7/30	0.010	0.25	0.032	0.81	0.269	6.83	16.6	6.2	27.8	50.1
C0724A	5	22	7/30	0.010	0.25	0.032	0.81	0.292	7.42	16.6	6.2	27.8	50.1
C0725A	6	22	7/30	0.010	0.25	0.032	0.81	0.317	8.05	16.6	6.2	25.5	45.9
C0726A	9	22	7/30	0.010	0.25	0.032	0.81	0.367	9.32	16.6	6.2	25.5	45.9
C0728A	15	22	7/30	0.010	0.25	0.032	0.81	0.457	11.62	16.6	6.2	25.5	45.9
C0729A	19	22	7/30	0.010	0.25	0.032	0.81	0.482	12.24	16.6	6.2	25.5	45.9
C0730A	27	22	7/30	0.010	0.25	0.032	0.81	0.576	14.36	16.6	6.2	26.0	46.0

*A – Capacitance between conductors

*B – Capacitance between one conductor and other conductors connected to shield

COLOR CODE CHART

NO. OF PAIRS	COLOR	NO. OF PAIRS	COLOR	NO. OF PAIRS	COLOR
1	Black with Red	10	Red with Blue	19	White with Blue
2	Black with White	11	Red with Yellow	20	White with Yellow
3	Black with Green	12	Red with Brown	21	White with Brown
4	Black with Blue	13	Red with Orange	22	White with Orange
5	Black with Yellow	14	Green with White	23	Blue with Yellow
6	Black with Brown	15	Green with Blue	24	Blue with Brown
7	Black with Orange	16	Green with Yellow	25	Blue with Orange
8	Red with White	17	Green with Brown	26	Brown with Yellow
9	Red with Green	18	Green with Orange	27	Brown with Orange



Multi-Paired, Foil Shield, Lo-Cap®

UL 2448, NEC Type CM (UL) c(UL), CMH

Product Construction:

Conductor:

- 24 AWG fully annealed stranded tinned copper per ASTM B33
- Twisted pairs

Insulation:

- Premium-grade, color-coded polyethylene
- Color code: See chart below

Shield:

- 100% Flexfoil® aluminum/polyester with 25% overlap, minimum, foil facing out
- Stranded tinned copper drain wire

Jacket:

- PVC, gray
- Temperature range: -20°C to +75°C

Applications:

- Computers
- Industrial equipment
- Data transmission
- Control circuits
- Suitable for low capacitance applications
- Suggested voltage rating: 30 volts

Compliances:

- NEC Article 800 Type CM (UL: 75°C)
- UL Style 2448 (UL: 60°C, 30 V)
- CSA CMH (CSA: 60°C)
- RoHS Compliant Directive 2015/863/EU (RoHS-3)
- Passes CSA CMH Flame Test

Packaging:

- Please contact Customer Service for packaging and color options



CATALOG NUMBER	NO. OF PAIRS	AWG SIZE	COND. STRAND	NOM. INSULATION THICKNESS		NOM. JACKET THICKNESS		NOMINAL O.D.		NOMINAL DCR Ω/kft		VEL. OF PROP. %	NOM. IMP. Ω	NOMINAL CAP.* pF/ft	
				in	mm	in	mm	in	mm	COND.	SHLD.			A	B
C0890A	2	24	7/32	0.015	0.38	0.032	0.81	0.247	6.27	25.7	7.20	66	100	14.4	26.0
C0901A	3	24	7/32	0.015	0.38	0.032	0.81	0.261	6.63	25.7	7.20	66	100	13.9	25.1
C0893A	4	24	7/32	0.015	0.38	0.032	0.81	0.277	7.04	25.7	7.20	66	100	13.9	25.1
C0894A	5	24	7/32	0.015	0.38	0.032	0.81	0.310	7.87	25.7	7.20	66	100	13.9	25.1
C0899A	6	24	7/32	0.015	0.38	0.032	0.81	0.336	8.53	25.7	7.20	66	100	13.0	23.4
C0896A	9	24	7/32	0.015	0.38	0.032	0.81	0.391	9.93	25.7	7.20	66	100	13.0	23.4
C0897A	12.5	24	7/32	0.015	0.38	0.032	0.97	0.459	11.66	25.7	7.20	66	100	13.0	23.4

*A – Capacitance between conductors

*B – Capacitance between one conductor and other conductors connected to shield
Data subject to change.

COLOR CODE CHART

NO. OF PAIRS	COLOR	NO. OF PAIRS	COLOR	NO. OF PAIRS	COLOR
1	Black paired with White	5	Purple paired with Gray	9	White/Orange paired with Orange/White
2	Red paired with Green	6	Tan paired with Pink	10	White/Green paired with Green/White
3	Brown paired with Blue	7	White/Blue paired with Blue/White	11	White/Red paired with Red/White
4	Orange paired with Yellow	8	White/Brown paired with Brown/White	12	White/Black paired with Black/White
Single Conductor: Green With Yellow Stripe					



Multi-Paired, Foil/Braid Shield

UL 2464, NEC/CEC Type CMR, CMG UL/CSA



Product Construction:

Conductor:

- 22 and 24 AWG fully annealed stranded tinned copper per ASTM B33
- Twisted pairs

Insulation:

- Premium-grade, color-coded PVC
- Color code: See chart below

Shield:

- 100% Flexfoil® aluminum/polyester with 25% overlap, minimum, foil facing out
- 65% tinned copper braid

Jacket:

- PVC, gray
- Temperature range: -20°C to +105°C

Applications:

- Computers
- Industrial equipment
- Data transmission
- Control circuits
- Suitable for EIA RS-232 applications
- Suggested voltage rating: 300 volts

Compliances:

- NEC Article 800 Type CMR (UL: 105°C)
- UL Style 2464 (UL: 80°C, 300 V)
- CSA CMG (CSA: 105°C)
- RoHS Compliant Directive 2015/863/EU (RoHS-3)
- Passes CSA CMG Flame Test

Packaging:

- Please contact Customer Service for packaging and color options
- Data subject to change.

CATALOG NUMBER	NO. OF PAIRS	AWG SIZE	COND. STRAND	NOMINAL INSULATION THICKNESS		NOMINAL JACKET THICKNESS		NOMINAL O.D.		NOMINAL DCR Ω/kft		NOMINAL CAP.* pF/ft	
				in	mm	in	mm	in	mm	COND.	SHLD.	A	B
C0620A	2	24	7/32	0.010	0.25	0.032	0.81	0.235	5.97	25.7	5.4	29.5	53.0
C0621A	3	24	7/32	0.010	0.25	0.032	0.81	0.231	5.87	25.7	5.0	26.4	47.6
C0622A	4	24	7/32	0.010	0.25	0.032	0.81	0.253	6.43	25.7	4.5	26.4	47.6
C0623A	5	24	7/32	0.010	0.25	0.032	0.81	0.278	7.06	25.7	4.6	26.4	47.6
C0624A	6	24	7/32	0.010	0.25	0.032	0.81	0.296	7.52	25.7	2.9	24.4	43.9
C0625A	7	24	7/32	0.010	0.25	0.032	0.81	0.313	7.95	25.7	3.1	24.4	43.9
C0626A	8	24	7/32	0.010	0.25	0.032	0.81	0.336	8.53	25.7	4.1	24.4	43.9
C0628A	10	24	7/32	0.010	0.25	0.032	0.81	0.357	9.07	25.7	2.6	24.4	43.9
C0630A	12.5	24	7/32	0.010	0.25	0.032	0.81	0.386	9.80	25.7	3.6	24.4	43.9
C0650A	2	22	7/30	0.010	0.25	0.032	0.81	0.229	5.82	16.6	3.8	33.2	59.7
C0651A	3	22	7/30	0.010	0.25	0.032	0.81	0.296	7.52	16.6	4.1	28.6	51.5
C0652A	4	22	7/30	0.010	0.25	0.032	0.81	0.320	8.13	16.6	3.5	28.6	51.5
C0653A	5	22	7/30	0.010	0.25	0.032	0.81	0.331	8.41	16.6	3.9	28.6	51.5
C0654A	6	22	7/30	0.010	0.25	0.032	0.81	0.348	8.84	16.6	4.4	26.2	47.2
C0655A	7	22	7/30	0.010	0.25	0.032	0.81	0.348	8.84	16.6	5.0	26.2	47.2
C0656A	8	22	7/30	0.010	0.25	0.032	0.81	0.368	9.35	16.6	3.8	26.2	47.2
C0658A	10	22	7/30	0.010	0.25	0.032	0.81	0.388	9.86	16.6	4.1	26.2	47.2
C0660A	12.5	22	7/30	0.010	0.25	0.032	0.81	0.429	10.90	16.6	4.7	26.2	47.2
C0663A	25	22	7/30	0.010	0.25	0.058	0.81	0.620	15.75	16.6	2.1	26.2	46.0

*A – Capacitance between conductors

*B – Capacitance between one conductor and other conductors connected to shield

COLOR CODE CHART

NO. OF PAIRS	COLOR	NO. OF PAIRS	COLOR	NO. OF PAIRS	COLOR
1	Black paired with Red	10	Red paired with Blue	19	White paired with Blue
2	Black paired with White	11	Red paired with Yellow	20	White paired with Yellow
3	Black paired with Green	12	Red paired with Brown	21	White paired with Brown
4	Black paired with Blue	13	Red paired with Orange	22	White paired with Orange
5	Black paired with Yellow	14	White paired with Green	23	Yellow paired with Blue
6	Black paired with Brown	15	Blue paired with Green	24	Blue paired with Brown
7	Black paired with Orange	16	Yellow paired with Green	25	Orange paired with Blue
8	Red paired with White	17	Brown paired with Green		
9	Red paired with Green	18	Orange paired with Green		

Single Conductor: Green With Yellow Stripe

Multi-Paired, Foil/Braid Shield, Lo-Cap®

UL 2919, NEC Type CM (UL) c(UL) CMH

Product Construction:

Conductor:

- 24 AWG fully annealed stranded tinned copper per ASTM B33
- Twisted pairs

Insulation:

- Premium-grade, color-coded polyethylene
- Color code: See charts below

Shield:

- 100% Flexfoil® aluminum/polyester with 25% overlap, minimum, foil facing out
- Stranded tinned copper drain wire
- 90% tinned copper braid

Jacket:

- PVC, gray
- Temperature range: -20°C to +80°C

Applications:

- Computers
- Industrial equipment
- Data transmission
- Control circuits
- Low capacitance requirements
- Suitable for EIA RS-485 applications
- Suggested voltage rating: 30 volts

Compliances:

- NEC Article 800 Type CM/CMH (UL: 75°C, 300 V)
- UL Style 2919 (UL: 80°C, 30 V)
- RoHS Compliant Directive 2015/863/EU (RoHS-3)
- Passes CSA CMH Flame Test

Packaging:

- Please contact Customer Service for packaging and color options



CATALOG NUMBER	NO. OF PAIRS	AWG SIZE	COND. STRAND	NOM. INSULATION THICKNESS		NOM. JACKET THICKNESS		NOMINAL O.D.		NOMINAL DCR Ω/kft		VEL. OF PROP. %	NOM. IMP. Ω	NOMINAL CAP.* pF/ft	
				in	mm	in	mm	in	mm	COND.	SHLD.			A	B
C0841A	1	24	7/32	0.024	0.61	0.032	0.81	0.235	5.97	25.7	2.9	66	120	14.6	26.2
C0842A	2	24	7/32	0.024	0.61	0.032	0.81	0.304	7.72	25.7	2.3	66	120	11.7	21.0
C0843A	3	24	7/32	0.024	0.61	0.032	0.81	0.360	9.14	25.7	2.3	66	120	11.9	21.4
C0844A	4	24	7/32	0.024	0.61	0.032	0.81	0.390	9.91	25.7	2.1	66	120	11.9	21.4

*A – Capacitance between conductors

*B – Capacitance between one conductor and other conductors connected to shield
Data subject to change.

COLOR CODE CHART 1

NO. OF PAIRS	COLOR
1	Black paired with Red
2	Black paired with White
3	Black paired with Green
4	Black paired with Blue

CATALOG NUMBER	NO. OF PAIRS	AWG SIZE	COND. STRAND	NOM. INSULATION THICKNESS		NOM. JACKET THICKNESS		NOMINAL O.D.		NOMINAL DCR Ω/kft		VEL. OF PROP. %	NOM. IMP. Ω	NOMINAL CAP.* pF/ft	
				in	mm	in	mm	in	mm	COND.	SHLD.			A	B
C4841A	1	24	7/32	0.024	0.61	0.032	0.81	0.235	5.97	25.7	2.9	66	120	14.6	26.2
C4842A	2	24	7/32	0.024	0.61	0.032	0.81	0.304	7.72	25.7	2.3	66	120	11.7	21.0
C4843A	3	24	7/32	0.024	0.61	0.032	0.81	0.360	9.14	25.7	2.3	66	120	11.9	21.4
C4844A	4	24	7/32	0.024	0.61	0.032	0.81	0.390	9.91	25.7	2.1	66	120	11.9	21.4

*A – Capacitance between conductors

*B – Capacitance between one conductor and other conductors connected to shield
Data subject to change.

COLOR CODE CHART 2

NO. OF PAIRS	COLOR	NO. OF PAIRS	COLOR
1	White-Blue Stripe Blue-White Stripe	1	White-Green Stripe Green-White Stripe
2	White-Orange Stripe Orange-White Stripe	2	White-Brown Stripe Brown-White Stripe



Multi-Paired, Foil/Braid Shield, Lo-Cap[®]

UL 2919, NEC Type CM (UL) c(UL) CMH



Product Construction:

Conductor:

- 24 AWG fully annealed stranded tinned copper per ASTM B33
- Twisted pairs

Insulation:

- Premium-grade, color-coded polyethylene
- Color code: See chart below

Shield:

- 100% Flexfoil[®] aluminum/polyester with 25% overlap, minimum, foil facing out
- Stranded tinned copper drain wire
- 90% tinned copper braid

Jacket:

- PVC, gray
- Temperature range: -20°C to +80°C

Applications:

- Computers
- Industrial equipment
- Data transmission
- Control circuits
- Low capacitance requirements
- Suitable for EIA RS-232 applications
- Suitable for EIA RS-422 applications

Compliances:

- NEC Article 800 Type CM/CMH (UL: 75°C)
- UL Style 2919 (UL: 80°C, 30 V)
- CSA CMH (CSA: 60°C)
- RoHS Compliant Directive 2015/863/EU (RoHS-3)
- Passes CSA CMH Flame Test

Packaging:

- Please contact Customer Service for packaging and color options

CATALOG NUMBER	NO. OF PAIRS	AWG SIZE	COND. STRAND	NOM. INSULATION THICKNESS		NOM. JACKET THICKNESS		NOMINAL O.D.		NOMINAL DCR Ω/kft		VEL. OF PROP. %	NOM. IMP. Ω	NOMINAL CAP.* pF/ft	
				in	mm	in	mm	in	mm	COND.	SHLD.			A	B
C0829A	2	24	7/32	0.015	0.38	0.032	0.81	0.257	6.53	25.7	2.7	66	100	14.8	26.7
C0830A	3	24	7/32	0.015	0.38	0.032	0.81	0.289	7.34	25.7	2.6	66	100	14.2	25.5
C0831A	4	24	7/32	0.015	0.38	0.032	0.81	0.313	7.95	25.7	3.2	66	100	14.2	25.5
C0832A	5	24	7/32	0.015	0.38	0.032	0.81	0.338	8.59	25.7	1.9	66	100	14.2	25.5
C0839A	6	24	7/32	0.015	0.38	0.032	0.81	0.364	9.24	25.7	2.4	66	100	13.2	23.8
C0833A	7	24	7/32	0.015	0.38	0.032	0.81	0.364	9.24	25.7	2.0	66	100	13.2	23.8
C0835A	10	24	7/32	0.015	0.38	0.038	0.97	0.462	11.73	25.7	1.7	66	100	13.2	23.8
C0836A	12	24	7/32	0.015	0.38	0.038	0.97	0.479	12.17	25.7	1.8	66	100	13.2	23.8

*A – Capacitance between conductors

*B – Capacitance between one conductor and other conductors connected to shield
Data subject to change.

COLOR CODE CHART

NO. OF COND.	COLOR	NO. OF COND.	COLOR
1	Black paired with Red	7	Black paired with Orange
2	Black paired with White	8	Red paired with White
3	Black paired with Green	9	Red paired with Green
4	Black paired with Blue	10	Red paired with Blue
5	Black paired with Yellow	11	Red paired with Yellow
6	Black paired with Brown	12	Red paired with Brown



Multi-Paired, Foil/Braid Shield, Lo-Cap®

UL 2919, NEC Type CM (UL) c(UL) CMH

Product Construction:

Conductor:

- 24 AWG fully annealed stranded tinned copper per ASTM B33
- Twisted pairs

Insulation:

- Premium-grade, color-coded Lo-Cap® foamed polypropylene
- Color code: See chart below

Shield:

- 100% Flexfoil® aluminum/polyester with 25% overlap, minimum, foil facing out
- Stranded tinned copper drain wire
- 65% tinned copper braid

Jacket:

- PVC, gray
- Temperature range: -20°C to +80°C

Applications:

- High-speed computer interconnects
- CAD/CAM systems
- EIA RS-232 and RS-423 systems
- Control circuits
- Industrial equipment
- Low signal distortion data requirements
- Suitable for EIA RS-485 120Ω applications

Compliances:

- NEC Article 800 Type CM/CMH (UL: 75°C, 300 V)
- UL Style 2919 (UL: 80°C, 30 V)
- RoHS Compliant Directive 2015/863/EU (RoHS-3)

Packaging:

- Please contact Customer Service for packaging and color options



CATALOG NUMBER	NO. OF PAIRS	AWG SIZE	COND. STRAND	NOM. INSULATION THICKNESS		NOM. JACKET THICKNESS		NOMINAL O.D.		NOMINAL DCR Ω/ft	VEL. OF PROP. %	NOM. IMP. Ω	NOMINAL CAP.* pF/ft		
				in	mm	in	mm	in	mm				COND.	SHLD.	A
C0515A	2	24	7/32	0.016	0.41	0.032	0.81	0.276	7.01	25.7	3.0	78	132	10.2	18.4
C0516A	3	24	7/32	0.016	0.41	0.032	0.81	0.290	7.37	25.7	3.2	78	132	9.9	17.8
C0517A	4	24	7/32	0.016	0.41	0.032	0.81	0.315	8.00	25.7	3.3	78	132	9.9	17.8
C0518A	5	24	7/32	0.016	0.41	0.032	0.81	0.340	8.64	25.7	4.2	78	132	9.9	17.8
C0519A	6	24	7/32	0.016	0.41	0.032	0.81	0.368	9.35	25.7	3.6	78	141	9.2	16.6
C0520A	7	24	7/32	0.016	0.41	0.032	0.81	0.370	9.40	25.7	3.5	78	141	9.2	16.6
C0521A	8	24	7/32	0.016	0.41	0.032	0.81	0.397	10.08	25.7	2.7	78	141	9.2	16.6
C0522A	10	24	7/32	0.016	0.41	0.038	0.97	0.473	12.01	25.7	2.4	78	141	9.2	16.6
C0523A	12.5	24	7/32	0.016	0.41	0.038	0.97	0.486	12.34	25.7	2.4	78	141	9.2	16.6
C0524A	15	24	7/32	0.016	0.41	0.048	1.22	0.555	14.10	25.7	2.6	78	141	9.2	16.6
C0525A	18	24	7/32	0.016	0.41	0.048	1.22	0.585	14.86	25.7	2.1	78	141	9.2	16.6
C0526A	25	24	7/32	0.016	0.41	0.048	1.22	0.677	17.20	25.7	2.0	78	141	9.2	16.6

*A – Capacitance between conductors

*B – Capacitance between one conductor and other conductors connected to shield

Data subject to change.

COLOR CODE CHART

NO. OF PAIRS	COLOR	NO. OF PAIRS	COLOR	NO. OF PAIRS	COLOR
1	White-Blue Stripe Blue-White Stripe	10	Red-Gray Stripe Gray-Red Stripe	19	Yellow-Brown Stripe Brown-Yellow Stripe
2	White-Orange Stripe Orange-White Stripe	11	Black-Blue Stripe Blue-Black Stripe	20	Yellow-Gray Stripe Gray-Yellow Stripe
3	White-Green Stripe Green-White Stripe	12	Black-Orange Stripe Orange-Black Stripe	21	Purple-Blue Stripe Blue-Purple Stripe
4	White-Brown Stripe Brown-White Stripe	13	Black-Green Stripe Green-Black Stripe	22	Purple-Orange Stripe Orange-Purple Stripe
5	White-Gray Stripe Gray-White Stripe	14	Black-Brown Stripe Brown-Black Stripe	23	Purple-Green Stripe Green-Purple Stripe
6	Red-Blue Stripe Blue-Red Stripe	15	Black-Gray Stripe Gray-Black Stripe	24	Purple-Brown Stripe Brown-Purple Stripe
7	Red-Orange Stripe Orange-Red Stripe	16	Yellow-Blue Stripe Blue-Yellow Stripe	25	Purple-Gray Stripe Gray-Purple Stripe
8	Red-Green Stripe Green-Red Stripe	17	Yellow-Orange Stripe Orange-Yellow Stripe		
9	Red-Brown Stripe Brown-Red Stripe	18	Yellow-Green Stripe Green-Yellow Stripe		

Single Conductor: Green With Yellow Stripe



Multi-Paired, Individually Foil Shielded

UL 2919, NEC Type CM, CSA CMH



Product Construction:

Conductor:

- 24 thru 18 AWG fully annealed stranded tinned copper per ASTM B33
- Twisted pairs

Insulation:

- Premium-grade, color-coded polyethylene
- Color code: See chart below

Shield:

- Individually shielded pairs
- 100% Flexfoil® aluminum/polyester with 25% overlap, minimum, foil facing in
- Stranded tinned copper drain wire each pair

Jacket:

- PVC, gray
- Temperature range: -20°C to +80°C

Applications:

- Applications for total isolation of signal
- Computers
- Control circuits
- Industrial equipment

Compliances:

- NEC Article 800 Type CM (UL: 75°C, 300 V)
- UL Style 2919 (UL: 80°C, 30 V)
- CSA CMH (CSA: 60°C)
- RoHS Compliant Directive 2015/863/EU (RoHS-3)
- Passes CSA CMH Flame Test

Packaging:

- Please contact Customer Service for packaging and color options

CATALOG NUMBER	NO. OF PAIRS	AWG SIZE	COND. STRAND	NOM. INSULATION THICKNESS		NOM. JACKET THICKNESS		NOMINAL O.D.		NOMINAL DCR Ω/kft		VEL OF PROP, %	NOM. IMP, Ω	NOMINAL CAP:** pF/ft	
				in	mm	in	mm	in	mm	COND.	SHLD.			A	B
C6065A	3	24	7/32	0.011	0.28	0.032	0.81	0.269	6.83	26.0	18.0	66	71	21.7	39.0
C6066A	6	24	7/32	0.011	0.28	0.032	0.81	0.349	8.86	26.0	18.0	66	71	21.7	39.0
C6067A	9	24	7/32	0.011	0.28	0.032	0.81	0.406	10.31	26.0	18.0	66	71	21.7	39.0
C6040A	3	22	7/30	0.011	0.28	0.032	0.81	0.292	7.42	16.5	11.3	66	63	24.4	43.9
C6041A	6	22	7/30	0.011	0.28	0.032	0.81	0.381	9.68	16.5	11.3	66	63	24.4	43.9
C6042A	9	22	7/30	0.011	0.28	0.032	0.81	0.445	11.30	16.5	11.3	66	63	24.4	43.9
C6043A	11	22	7/30	0.011	0.28	0.032	0.81	0.486	12.34	16.5	11.3	66	63	24.4	43.9
C6059A	12	22	7/30	0.011	0.28	0.048	1.22	0.533	13.54	16.5	11.3	66	63	24.4	43.9
C6044A	15	22	7/30	0.011	0.28	0.048	1.22	0.591	15.01	16.5	11.3	66	63	24.4	43.9
C6060A	17	22	7/30	0.011	0.28	0.048	1.22	0.622	15.80	16.5	11.3	66	63	24.4	43.9
C6045A	19	22	7/30	0.011	0.28	0.048	1.22	0.622	15.80	16.5	11.3	66	63	24.4	43.9
C6046A*	27	22	7/30	0.011	0.28	0.048	1.22	0.696	17.68	16.5	11.3	66	63	24.4	43.9
C6052A	3	20	7/28	0.013	0.33	0.032	0.81	0.339	8.61	10.5	10.2	66	61	25.3	45.6
C6053A	6	20	7/28	0.013	0.33	0.032	0.81	0.446	11.33	10.5	10.2	66	61	25.3	45.6
C6054A	9	20	7/28	0.013	0.33	0.048	1.22	0.555	14.10	10.5	10.2	66	61	25.3	45.6
C6056A	12	20	7/28	0.013	0.33	0.048	1.22	0.623	15.82	10.5	10.2	66	61	25.3	45.6
C6058A	15	20	7/28	0.013	0.33	0.048	1.22	0.692	17.58	10.5	10.2	66	61	25.3	45.6
C6047A	3	18	16/30	0.016	0.41	0.032	0.81	0.395	10.03	7.2	8.3	66	60	25.7	46.2
C6048A	6	18	16/30	0.016	0.41	0.048	1.22	0.556	14.12	7.2	8.3	66	60	25.7	46.2
C6049A	9	18	16/30	0.016	0.41	0.048	1.22	0.649	16.48	7.2	8.3	66	60	25.7	46.2
C6050A	12	18	16/30	0.016	0.41	0.048	1.22	0.731	18.57	7.2	8.3	66	60	25.7	46.2
C6051A	15	18	16/30	0.016	0.41	0.048	1.22	0.776	19.71	7.2	8.3	66	60	25.7	46.2

*UL 2919, CSA CMH Only

**A – Capacitance between conductors

**B – Capacitance between one conductor and other conductors connected to shield

Data subject to change.

COLOR CODE CHART

NO. OF PAIRS	COLOR	NO. OF PAIRS	COLOR	NO. OF PAIRS	COLOR
1	Black paired with Red	10	Red paired with Blue	19	White paired with Blue
2	Black paired with White	11	Red paired with Yellow	20	White paired with Yellow
3	Black paired with Green	12	Red paired with Brown	21	White paired with Brown
4	Black paired with Blue	13	Red paired with Orange	22	White paired with Orange
5	Black paired with Yellow	14	Green paired with White	23	Blue paired with Yellow
6	Black paired with Brown	15	Green paired with Blue	24	Blue paired with Brown
7	Black paired with Orange	16	Green paired with Yellow	25	Blue paired with Orange
8	Red paired with White	17	Green paired with Brown	26	Brown paired with Yellow
9	Red paired with Green	18	Green paired with Orange	27	Brown paired with Orange



Multi-Paired, Individually Foil Shielded, Lo-Cap®

UL 2493, NEC Type CM (UL) c(UL) CMH

Product Construction:

Conductor:

- 24 AWG fully annealed stranded tinned copper per ASTM B33
- Twisted pairs

Insulation:

- Premium-grade, color-coded foamed Lo-Cap® polypropylene
- Color code: See chart below

Shield:

- Individually shielded pairs
- 100% Flexfoil® aluminum/polyester with 25% overlap, minimum, foil facing in
- Stranded tinned copper drain wire each pair

Jacket:

- PVC, gray
- Temperature range: -20°C to +75°C

Applications:

- High-speed computers
- Industrial equipment
- Control circuits
- Suitable for low capacitance applications
- Suitable for EIA RS-422 CAD/CAM applications
- Suggested voltage rating: 300 volts

Compliances:

- NEC Article 800 Type CM/CMH (UL: 75°C, 300 V)
- UL Style 2493 (UL: 60°C)
- RoHS Compliant Directive 2015/863/EU (RoHS-3)

Packaging:

- Please contact Customer Service for packaging and color options



CATALOG NUMBER	NO. OF PAIRS	AWG SIZE	COND. STRAND	NOM. INSULATION THICKNESS		NOM. JACKET THICKNESS		NOMINAL O.D.		NOMINAL DCR Ω/ft		VEL. OF PROP. %	NOM. IMP. Ω	NOMINAL CAP.* pF/ft	
				in	mm	in	mm	in	mm	COND.	SHLD.			A	B
C0910A	2	24	7/32	0.022	0.56	0.047	1.19	0.283	7.19	26.0	18.0	78	100	14.8	26.7
C0911A	3	24	7/32	0.022	0.56	0.048	1.22	0.381	9.68	26.0	18.0	78	100	14.8	26.7
C0912A	4	24	7/32	0.022	0.56	0.048	1.22	0.416	10.57	26.0	18.0	78	100	14.8	26.7
C0913A	6	24	7/32	0.022	0.56	0.048	1.22	0.492	12.50	26.0	18.0	78	100	14.8	26.7
C0914A	9	24	7/32	0.022	0.56	0.063	1.60	0.601	15.27	26.0	18.0	78	100	14.8	26.7
C0915A	11	24	7/32	0.022	0.56	0.063	1.60	0.652	16.56	26.0	18.0	78	100	14.8	26.7
C0916A	12	24	7/32	0.022	0.56	0.063	1.60	0.672	17.08	26.0	18.0	78	100	14.8	26.7
C0917A	15	24	7/32	0.022	0.56	0.063	1.60	0.743	18.87	26.0	18.0	78	100	14.8	26.7

*A – Capacitance between conductors

*B – Capacitance between one conductor and other conductors connected to shield
Data subject to change.

COLOR CODE CHART

NO. OF COND.	COLOR	NO. OF COND.	COLOR	NO. OF COND.	COLOR
1	Black paired with Red	6	Black paired with Brown	11	Red paired with Yellow
2	Black paired with White	7	Black paired with Orange	12	Red paired with Brown
3	Black paired with Green	8	Red paired with White	13	Red paired with Orange
4	Black paired with Blue	9	Red paired with Green	14	Green paired with White
5	Black paired with Yellow	10	Red paired with Blue	15	Green paired with Blue

Multi-Paired, Individually Foil/Braid Shielded, Lo-Cap®

UL 2493, NEC Type CM (UL) c(UL) CMH

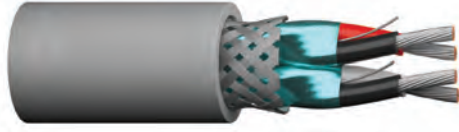

CATALOG NUMBER	NO. OF PAIRS	AWG SIZE	COND. STRAND	NOM. INSULATION THICKNESS		NOM. JACKET THICKNESS		NOMINAL O.D.		NOMINAL DCR**			VEL. OF PROP. %	NOM. IMP. Ω	NOMINAL CAP.*	
				in	mm	in	mm	in	mm	C	D	E			A	B
C0924A	2	24	7/32	0.022	0.56	0.048	1.22	0.392	9.96	26.0	18.0	4.3	78	100	14.8	26.7
C0925A	3	24	7/32	0.022	0.56	0.048	1.22	0.410	10.41	26.0	18.0	4.4	78	100	14.8	26.7
C0926A	4	24	7/32	0.022	0.56	0.048	1.22	0.445	11.30	26.0	18.0	3.2	78	100	14.8	26.7

*A – Capacitance between conductors
 *B – Capacitance between one conductor and other conductors connected to shield
 **C – Conductor resistance
 **D – Individual shield resistance
 **E – Overall shield resistance
 Data subject to change.

COLOR CODE CHART

NO. OF PAIRS	COLOR
1	Black paired with Red
2	Black paired with White
3	Black paired with Green
4	Black paired with Blue

Product Construction:

Conductor:

- 24 AWG fully annealed stranded tinned copper per ASTM B33
- Twisted pairs

Insulation:

- Premium-grade, color-coded foamed Lo-Cap® polypropylene
- Color code: See chart below

Shield:

- Individually shielded pairs
- 100% Flexfoil® aluminum/polyester with 25% overlap, minimum, foil facing in
- Stranded tinned copper drain wire, each pair
- 70% tinned copper braid

Jacket:

- PVC, gray
- Temperature range: -20°C to +75°C

Applications:

- High-speed computers
- Industrial equipment
- Control circuits
- Designed for low capacitance applications
- Suitable for RS-422 CAD/CAM applications
- Suggested voltage rating: 300 volts

Compliances:

- NEC Article 800 Type CM/CMH (UL: 75°C, 300 V)
- UL Style 2493 (UL: 60°C)
- RoHS Compliant Directive 2015/863/EU (RoHS-3)

Packaging:

- Please contact Customer Service for packaging and color options

EXZEL® High-Endurance Cables

4



As a full electronics solutions provider with a commitment to designing innovative cable constructions, Prysmian recognizes the growing demand for a higher performance line of electronic wire and cable to support emerging technology, mission-critical applications and today's environmental concerns. That's why we've introduced a new, tougher addition to the CAROL® Brand family – EXZEL High-Endurance Electronic Cables.

Prysmian's new EXZEL High-Endurance Electronic Cables are engineered for extreme environments where unparalleled performance is critical and cable failures are not an option. An exceptional choice that offers complete peace of mind, this new cabling line exzels in applications where oil, liquids, vapors or other substances can attack the jacketing of conventional "round gray" PVC electronic cables. Along with improved jacketing performance, EXZEL's innovative Dual Foil/Braid Shield technology provides more effective shielding. This dual-foil design with 85% copper-braid coverage significantly reduces electromagnetic and radio frequency interference (EMI/RFI) over traditional single-foil tape designs.

In response to environmental concern surrounding the burning of halogens, Prysmian also offers the Low-Smoke, Zero-Halogen (LSZH) line of EXZEL High-Endurance Electronic Cables. To reduce the toxicity and corrosive effects that may impact people and equipment, CAROL Brand's EXZEL LSZH construction produces low amounts of smoke and acid gas during a fire, while maintaining the same flame requirements, electrical performance and longevity as traditional cable constructions.

Whether you are involved with a green building installation or simply looking for ways to safeguard people and protect the environment, EXZEL High-Endurance Electronic Cables provide a true "green" alternative. And with EXZEL, U.S. manufacturers now have access to a domestic LSZH cable solution required for use on equipment that may be sold internationally.

Section	Page
CAROL Brand EXZEL Guide	60-62
Multi-Conductor, Unshielded	63
Multi-Conductor, Foil Shielded	64
Multi-Conductor, Foil/Braid Shielded	65
Multi-Paired, Unshielded	66
Multi-Paired, Foil Shielded	67
Multi-Paired, Foil/Braid Shielded	68
Multi-Conductor, Unshielded, Heavy Duty	69
Multi-Conductor, Foil Shielded, Heavy Duty	70
Multi-Conductor, Foil/Braid Shielded, Heavy Duty	71
Multi-Paired, Foil/Braid Shielded, Heavy Duty	72
LSZH Multi-Conductor, Unshielded	73
LSZH Multi-Conductor, Foil Shielded	74
LSZH Multi-Conductor, Foil/Braid Shielded	75
LSZH Multi-Paired, Unshielded	76
LSZH Multi-Paired, Foil Shielded	77
LSZH Multi-Paired, Foil/Braid Shielded	78
Color Code Charts	79

CAROL® Brand EXZEL® Complete Peace of Mind

READY TO SERVE

For more than 60 years, Prysmian has met the ever-changing needs of major Original Equipment Manufacturers (OEMs) and the most demanding, high-volume bulk requirements of Maintenance Repair Operations (MROs), as well as smaller, niche OEMs around the world. Uniquely qualified to provide superior engineering, products and value-added services, Prysmian's customers represent a virtual "who's who" of the industries we serve. All CAROL® Brand's EXZEL® High-Endurance Electronic Cables are ideal for use in the following markets and applications:

Manufacturing

- Device communications
- Control interconnect
- PLC networking
- Industrial machinery

Food and Beverage

- Meat and food processing
- Bottling plants
- Packaging machines

Semiconductor

- Robotic handling systems
- Class I, Division 2
- Automated test equipment
- Wafer processing equipment

Utilities

- Wastewater treatment plants
- Wind turbine control
- Gas delivery communications

Military

- Mobile communications
- Avionics control

Process

- Remote monitoring
- Discrete/analog signaling

Medical Diagnostics

- Digital imaging control
- Biomedical

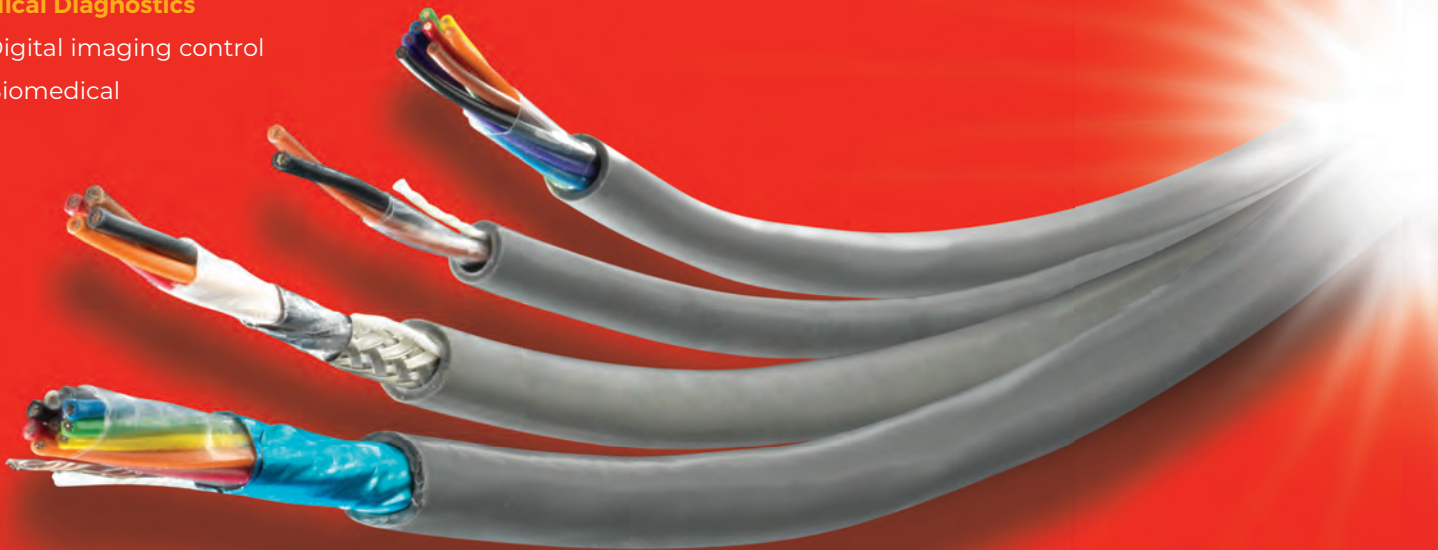

BACKED BY QUALITY

EXZEL® High-Endurance Electronic Cables are manufactured with the selection, quality and dependability our customers have come to expect from CAROL® Brand cables. From special jacket colors, print legends and TRU-Mark® sequential footage markings to unique constructions, innovative materials and quality manufacturing, Prysmian's expert engineers offer superior service and design assistance. Most of our products carry UL, ETL, RoHS, CSA and other major approvals from around the globe.

Need a specific construction not available in our standard stock? We have you covered. Prysmian will customize any standard EXZEL cable construction to meet your unique application requirements, including:

- Jacket colors
- Gauge sizes
- Conductor count and construction
- Insulation and jacket construction
- Shielding options
- Armoring
- Composites

EXZEL's LSZH cables, as well as all of our High-Endurance cables, are manufactured in Prysmian's Franklin, Massachusetts and Manchester, New Hampshire facilities — both of which are recognized among North America's Top 10 Best Manufacturing Plants by INDUSTRYWEEK Magazine.

When exceptional performance and reliability are critical to your application, put your trust in CAROL Brand EXZEL.

Comparison of Traditional Round Gray Electronic Cables to EXZEL High-Endurance Electronic Cables

	Traditional Round Gray Electronic Cables	EXZEL PVC	EXZEL LSZH
Conductor Type	Tinned Copper	Tinned Copper	Tinned Copper
Conductor Strand	7/XX	Flexible	Flexible
Insulation	PVC	PVC	LSZH
Shielding	Limited	Full	Full
Braid Coverage	70	70	85
Jacket	PVC	PVC	LSZH
Footage Markings	No	TRU-Mark	Yes
Temp Rating	80 °C	105 °C	105 °C
Oil Resistance	No	No	OR I*
UV Resistance	No	Yes	Yes
NEC/UL Type CM	Yes (80 °C)	Yes (105 °C)	Yes
UL AWM	Style 2464	Style 2464	N/A
CSA CMG	Yes (80 °C)	Yes (105 °C)	No
UL PLTC-ER	No	No	Yes
PLTC	No	No	Yes
UL Flame Rating	UL 1581	UL 1581	UL 1581
CSA Flame Rating	FT4	FT4	FT4

*OR I = UL Oil Resistance I

FEATURES AND BENEFITS OF CAROL® BRAND EXZEL®

- Reduced downtime for lower cost of ownership
- Superior reliability, even in the harshest environments available
- Extensive selection to meet application needs
- Optimum lifespan in severe operating conditions
- Highest available shield coverage for maximum EMI/RFI resistance
- Low-Smoke, Zero-Halogen constructions available
- Premium-grade PVC insulation and jacket available for routing in tight spaces
- Resistant to most oils (UL Class 43) and to ambient temperatures up to 105°C

SURFACE TRANSFER IMPEDANCES (STI)

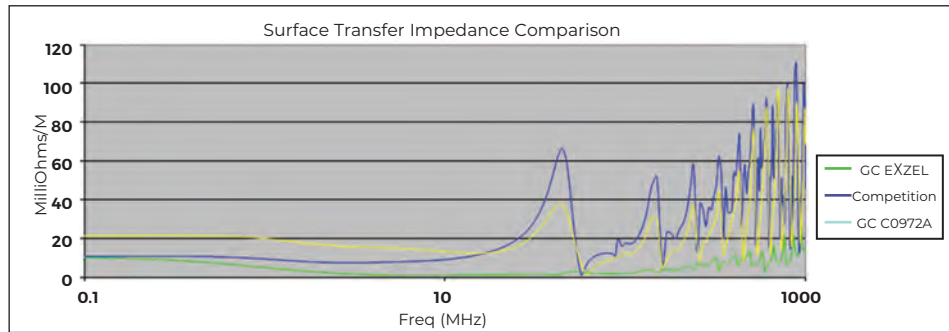

Why Prysmian?

Unrivaled service. Unparalleled innovation. Unmatched industry leadership.

At Prysmian, we believe quality is what we put in your product. That's why we employ a LeanSigma management philosophy that eliminates waste and non-value-added processes to improve the flow of information and materials. Always searching for new and better ways of doing things, Prysmian consistently identifies and eliminates sources of variation while reducing cycle time and inventory, ensuring better capacity and space utilization and improving productivity. We have the right mix of people, equipment and experience to produce custom cables, wire harnesses and cable assemblies of the highest complexity and quality

- High-Endurance Electronic products that exzel!
- Certified ISO 9001 manufacturing facilities
- Rigorous performance standards
- Ongoing R&D for an ever-growing range of materials
- Superior materials and proactive prevention
- Comprehensive process control and quality audits
- Stringent in-house and third-party testing

Prysmian is an environmentally conscious company committed to reducing and, where possible, eliminating hazardous substances. Our facilities have fully implemented an ISO 14001-equivalent environmental management system with strict oversight to ensure that regulatory compliance is met or exceeded. All applicable products are certified or are being upgraded to meet RoHS standards, and we are working to comply with evolving REACH requirements as they pertain to wire and cable products and materials.

THE BOTTOM LINE

Prysmian recognizes and values the vital importance of total, exceptional customer satisfaction, and we have the experience and know-how to achieve it. Our people may come to work for us, but on the job, our Wire Wizards work for you. Put us to work and see what we can do for you.

EXZEL® Multi-Conductor, Unshielded

UL 2464, NEC Type CM (UL), CSA CMG

Product Construction:

Conductor:

- Fully annealed stranded tinned copper per ASTM B33

Insulation:

- Premium-grade, color-coded PVC
- Color per Chart A for 24 AWG and 22 AWG on page 97
- Color per Chart B for 20 AWG and larger on page 97
- International colors per IEC Color Chart on page 97

Shield:

- Unshielded

Jacket:

- Premium PVC
- Operating temperature range:
-30°C to +105°C (Type CM)
-30°C to +80°C (AWM)

Applications:

- Advanced signal transmission in controlled environments
- Medical instrumentation and equipment
- Consumer electronic peripherals
- Industrial process control systems
- Suitable for EIA RS-232 applications

Features:

- Oil-resistant per UL Oil Res I and Class 43
- Sunlight-resistant per UL 720-hr. UV test
- Nylon ripcord

Compliances:

- NEC Article 800 Type CM (UL: 105°C)
- UL Style 2464 (UL: 80°C, 300 V, VW-1)
- CSA Type CMG (CSA: 105°C, FT4)
- RoHS Compliant Directive 2015/863/EU (RoHS-3)
- Vertical Tray Cable Flame Test per UL 1581 and IEEE 383 (70,000 BTU)

Packaging

- Please contact Customer Service for packaging and color options
- Data subject to change.



PART NUMBER	COND.	AWG SIZE	COND. STRAND	NOMINAL INSULATION THICKNESS		NOMINAL JACKET THICKNESS		NOMINAL CABLE DIAMETER	
				in	mm	in	mm	INCHES	mm
C9000A	2	24	7/32	0.010	0.25	0.032	0.81	0.155	3.94
C9001A	3	24	7/32	0.010	0.25	0.032	0.81	0.161	4.10
C9002A	4	24	7/32	0.010	0.25	0.032	0.81	0.173	4.40
C9003A	6	24	7/32	0.010	0.25	0.032	0.81	0.198	5.03
C9004A	8	24	7/32	0.010	0.25	0.032	0.81	0.211	5.37
C9005A	10	24	7/32	0.010	0.25	0.032	0.81	0.241	6.12
C9006A	15	24	7/32	0.010	0.25	0.032	0.81	0.271	6.89
C9007A	20	24	7/32	0.010	0.25	0.032	0.81	0.297	7.55
C9008A	25	24	7/32	0.010	0.25	0.032	0.81	0.327	8.31
C9009A	2	22	7/30	0.010	0.25	0.032	0.81	0.167	4.24
C9010A	3	22	7/30	0.010	0.25	0.032	0.81	0.174	4.43
C9011A	4	22	7/30	0.010	0.25	0.032	0.81	0.188	4.76
C9012A	6	22	7/30	0.010	0.25	0.032	0.81	0.216	5.49
C9013A	8	22	7/30	0.010	0.25	0.032	0.81	0.231	5.87
C9014A	10	22	7/30	0.010	0.25	0.032	0.81	0.265	6.73
C9015A	15	22	7/30	0.010	0.25	0.032	0.81	0.299	7.60
C9016A	20	22	7/30	0.010	0.25	0.032	0.81	0.329	8.36
C9017A	25	22	7/30	0.010	0.25	0.032	0.81	0.363	9.22
C9018A	2	20	7/28	0.016	0.41	0.032	0.81	0.205	5.21
C9019A	3	20	7/28	0.016	0.41	0.032	0.81	0.215	5.47
C9020A	4	20	7/28	0.016	0.41	0.032	0.81	0.234	5.93
C9021A	6	20	7/28	0.016	0.41	0.032	0.81	0.273	6.93
C9022A	8	20	7/28	0.016	0.41	0.032	0.81	0.294	7.47
C9023A	10	20	7/28	0.016	0.41	0.032	0.81	0.341	8.66
C9024A	15	20	7/28	0.016	0.41	0.032	0.81	0.389	9.87
C9025A	20	20	7/28	0.016	0.41	0.032	0.81	0.430	10.92
C9026A	25	20	7/28	0.016	0.41	0.032	0.81	0.477	12.12
C9027A*	2	18	16/30	0.016	0.41	0.032	0.81	0.225	5.72
C9028A	2	18	16/30	0.016	0.41	0.032	0.81	0.225	5.72
C9029A*	3	18	16/30	0.016	0.41	0.032	0.81	0.237	6.01
C9030A	3	18	16/30	0.016	0.41	0.032	0.81	0.237	6.01
C9031A	4	18	16/30	0.016	0.41	0.032	0.81	0.258	6.55
C9032A	6	18	16/30	0.016	0.41	0.032	0.81	0.303	7.70
C9033A	8	18	16/30	0.016	0.41	0.032	0.81	0.327	8.31
C9034A	10	18	16/30	0.016	0.41	0.032	0.81	0.381	9.68
C9035A	15	18	16/30	0.016	0.41	0.032	0.81	0.436	11.06
C9036A	20	18	16/30	0.016	0.41	0.032	0.81	0.483	12.27
C9037A	25	18	16/30	0.016	0.41	0.032	0.81	0.537	13.64
C9038A*	2	16	19/0117	0.016	0.41	0.032	0.81	0.245	6.22
C9039A	2	16	19/0117	0.016	0.41	0.032	0.81	0.245	6.22
C9040A*	3	16	19/0117	0.016	0.41	0.032	0.81	0.258	6.56
C9041A	3	16	19/0117	0.016	0.41	0.032	0.81	0.258	6.56
C9042A	4	16	19/0117	0.016	0.41	0.032	0.81	0.282	7.16
C9043A	6	16	19/0117	0.016	0.41	0.032	0.81	0.333	8.46
C9044A	8	16	19/0117	0.016	0.41	0.032	0.81	0.360	9.15
C9045A	10	16	19/0117	0.016	0.41	0.032	0.81	0.421	10.69
C9046A	15	16	19/0117	0.016	0.41	0.032	0.81	0.483	12.26
C9047A	20	16	19/0117	0.016	0.41	0.053	1.35	0.578	14.69
C9048A	25	16	19/0117	0.016	0.41	0.053	1.35	0.639	16.23

* IEC Color Code: Brown, Blue, Green/Yellow



EXZEL® Multi-Conductor, Foil Shielded

UL 2464, NEC Type CM (UL), CSA CMG

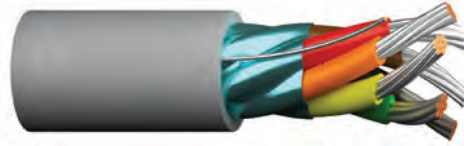

Product Construction:

Conductor:

- Fully annealed stranded tinned copper per ASTM B33

Insulation:

- Premium-grade, color-coded PVC
- Color per Chart A for 24 AWG and 22 AWG on page 97
- Color per Chart B for 20 AWG and larger on page 97
- International colors per IEC Color Chart on page 97

Shield:

- 100% Flexfoil® aluminum/polyester, foil facing in
- Stranded tinned copper drain wire

Jacket:

- Premium PVC
- Operating temperature range: -30°C to +105°C (Type CM)
- -30°C to +80°C (AWM)

Applications:

- Advanced signal transmission in controlled environments
- Medical instrumentation and equipment
- Consumer electronic peripherals
- Industrial process control systems
- Suitable for EIA RS-232 applications

Features:

- Oil-resistant per UL Oil Res I and Class 43
- Sunlight-resistant per UL 720-hr. UV test
- Nylon ripcord

Compliances:

- NEC Article 800 Type CM (UL: 105°C)
- UL Style 2464 (UL: 80°C, 300 V, VW-1)
- CSA Type CMG (CSA: 105°C, FT4)
- RoHS Compliant Directive 2015/863/EU (RoHS-3)
- Vertical Tray Cable Flame Test per UL 1581 and IEEE 383 (70,000 BTU)

Packaging:

- Please contact Customer Service for packaging and color options
- Data subject to change.

PART NUMBER	COND.	AWG SIZE	COND. STRAND	NOMINAL INSULATION THICKNESS		NOMINAL JACKET THICKNESS		NOMINAL CABLE DIAMETER	
				in	mm	in	mm	in	mm
C9100A	2	24	7/32	0.010	0.25	0.032	0.81	0.157	3.99
C9101A	3	24	7/32	0.010	0.25	0.032	0.81	0.163	4.15
C9102A	4	24	7/32	0.010	0.25	0.032	0.81	0.175	4.45
C9103A	6	24	7/32	0.010	0.25	0.032	0.81	0.200	5.08
C9104A	8	24	7/32	0.010	0.25	0.032	0.81	0.213	5.42
C9105A	10	24	7/32	0.010	0.25	0.032	0.81	0.243	6.17
C9106A	15	24	7/32	0.010	0.25	0.032	0.81	0.273	6.94
C9107A	20	24	7/32	0.010	0.25	0.032	0.81	0.299	7.60
C9108A	25	24	7/32	0.010	0.25	0.032	0.81	0.329	8.36
C9109A	2	22	7/30	0.010	0.25	0.032	0.81	0.169	4.29
C9110A	3	22	7/30	0.010	0.25	0.032	0.81	0.176	4.48
C9111A	4	22	7/30	0.010	0.25	0.032	0.81	0.190	4.82
C9112A	6	22	7/30	0.010	0.25	0.032	0.81	0.218	5.54
C9113A	8	22	7/30	0.010	0.25	0.032	0.81	0.233	5.92
C9114A	10	22	7/30	0.010	0.25	0.032	0.81	0.267	6.78
C9115A	15	22	7/30	0.010	0.25	0.032	0.81	0.301	7.65
C9116A	20	22	7/30	0.010	0.25	0.032	0.81	0.331	8.41
C9117A	25	22	7/30	0.010	0.25	0.032	0.81	0.365	9.27
C9118A	2	20	7/28	0.016	0.41	0.032	0.81	0.207	5.26
C9119A	3	20	7/28	0.016	0.41	0.032	0.81	0.217	5.52
C9120A	4	20	7/28	0.016	0.41	0.032	0.81	0.236	5.98
C9121A	6	20	7/28	0.016	0.41	0.032	0.81	0.275	6.99
C9122A	8	20	7/28	0.016	0.41	0.032	0.81	0.296	7.52
C9123A	10	20	7/28	0.016	0.41	0.032	0.81	0.343	8.71
C9124A	15	20	7/28	0.016	0.41	0.032	0.81	0.391	9.92
C9125A	20	20	7/28	0.016	0.41	0.032	0.81	0.432	10.97
C9126A	25	20	7/28	0.016	0.41	0.032	0.81	0.479	12.17
C9127A	2	18	16/30	0.016	0.41	0.032	0.81	0.227	5.77
C9128A*	2	18	16/30	0.016	0.41	0.032	0.81	0.227	5.77
C9129A	3	18	16/30	0.016	0.41	0.032	0.81	0.239	6.06
C9130A*	3	18	16/30	0.016	0.41	0.032	0.81	0.239	6.06
C9131A	4	18	16/30	0.016	0.41	0.032	0.81	0.260	6.60
C9132A	6	18	16/30	0.016	0.41	0.032	0.81	0.305	7.75
C9133A	8	18	16/30	0.016	0.41	0.032	0.81	0.329	8.36
C9134A	10	18	16/30	0.016	0.41	0.032	0.81	0.383	9.73
C9135A	15	18	16/30	0.016	0.41	0.032	0.81	0.438	11.12
C9136A	20	18	16/30	0.016	0.41	0.032	0.81	0.485	12.32
C9137A	25	18	16/30	0.016	0.41	0.032	0.81	0.539	13.69
C9138A	2	16	19/0117	0.016	0.41	0.032	0.81	0.247	6.27
C9139A*	2	16	19/0117	0.016	0.41	0.032	0.81	0.247	6.27
C9140A	3	16	19/0117	0.016	0.41	0.032	0.81	0.260	6.61
C9141A*	3	16	19/0117	0.016	0.41	0.032	0.81	0.260	6.61
C9142A	4	16	19/0117	0.016	0.41	0.032	0.81	0.284	7.21
C9143A	6	16	19/0117	0.016	0.41	0.032	0.81	0.335	8.51
C9144A	8	16	19/0117	0.016	0.41	0.032	0.81	0.362	9.20
C9145A	10	16	19/0117	0.016	0.41	0.032	0.81	0.423	10.74
C9146A	15	16	19/0117	0.016	0.41	0.032	0.81	0.485	12.31
C9147A	20	16	19/0117	0.016	0.41	0.053	1.35	0.580	14.74
C9148A	25	16	19/0117	0.016	0.41	0.053	1.35	0.641	16.28

* IEC Color Code: Brown, Blue, Green/Yellow



EXZEL® Multi-Conductor, Foil/Braid Shielded

UL 2464, NEC Type CM (UL), CSA CMG

Product Construction:

Conductor:

- Fully annealed stranded tinned copper per ASTM B33

Insulation:

- Premium-grade, color-coded PVC
- Color per Chart A for 24 AWG and 22 AWG on page 97
- Color per Chart B for 20 AWG and larger on page 97
- International colors per IEC Color Chart on page 97

Shield:

- Dual foil with overall braided shield
- Aluminum/polyester/aluminum foil with 100% coverage
- Stranded tinned copper drain wire
- Tinned copper braided shield, 70% min coverage

Jacket:

- Premium PVC
- Operating temperature range: -30°C to +105°C (Type CM)
- -30°C to +80°C (AWM)

Applications:

- Advanced signal transmission in controlled environments
- Medical instrumentation and equipment
- Consumer electronic peripherals
- Industrial process control systems
- Suitable for EIA RS-232 applications

Features:

- Oil-resistant per UL Oil Res I and Class 43
- Sunlight-resistant
- Nylon ripcord

Compliances:

- NEC Article 800 Type CM (UL: 105°C)
- UL Style 2464 (UL: 80°C, 300 V, VW-1)
- CSA Type CMG (CSA: 105°C, FT4)
- RoHS Compliant Directive 2015/863/EU (RoHS-3)
- Vertical Tray Cable Flame Test per UL 1581 and IEEE 383 (70,000 BTU)

Packaging:

- Please contact Customer Service for packaging and color options
- Data subject to change.

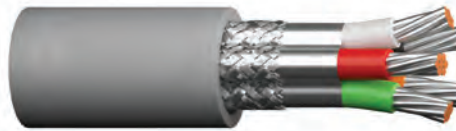

PART NUMBER	COND.	AWG SIZE	COND. STRAND	NOMINAL INSULATION THICKNESS		NOMINAL JACKET THICKNESS		NOMINAL CABLE DIAMETER	
				in	mm	in	mm	in	mm
C9200A	2	24	7/32	0.010	0.25	0.032	0.81	0.184	4.67
C9201A	3	24	7/32	0.010	0.25	0.032	0.81	0.190	4.84
C9202A	4	24	7/32	0.010	0.25	0.032	0.81	0.202	5.13
C9203A	6	24	7/32	0.010	0.25	0.032	0.81	0.227	5.77
C9204A	8	24	7/32	0.010	0.25	0.032	0.81	0.240	6.10
C9205A	10	24	7/32	0.010	0.25	0.032	0.81	0.270	6.86
C9206A	15	24	7/32	0.010	0.25	0.032	0.81	0.300	7.62
C9207A	20	24	7/32	0.010	0.25	0.032	0.81	0.326	8.29
C9208A	25	24	7/32	0.010	0.25	0.032	0.81	0.356	9.04
C9209A	2	22	7/30	0.010	0.25	0.032	0.81	0.196	4.98
C9210A	3	22	7/30	0.010	0.25	0.032	0.81	0.203	5.17
C9211A	4	22	7/30	0.010	0.25	0.032	0.81	0.217	5.50
C9212A	6	22	7/30	0.010	0.25	0.032	0.81	0.245	6.22
C9213A	8	22	7/30	0.010	0.25	0.032	0.81	0.260	6.61
C9214A	10	22	7/30	0.010	0.25	0.032	0.81	0.294	7.47
C9215A	15	22	7/30	0.010	0.25	0.032	0.81	0.328	8.34
C9216A	20	22	7/30	0.010	0.25	0.032	0.81	0.358	9.10
C9217A	25	22	7/30	0.010	0.25	0.032	0.81	0.392	9.96
C9218A	2	20	7/28	0.016	0.41	0.032	0.81	0.234	5.94
C9219A	3	20	7/28	0.016	0.41	0.032	0.81	0.244	6.20
C9220A	4	20	7/28	0.016	0.41	0.032	0.81	0.263	6.67
C9221A	6	20	7/28	0.016	0.41	0.032	0.81	0.302	7.67
C9222A	8	20	7/28	0.016	0.41	0.032	0.81	0.323	8.21
C9223A	10	20	7/28	0.016	0.41	0.032	0.81	0.370	9.40
C9224A	15	20	7/28	0.016	0.41	0.032	0.81	0.418	10.61
C9225A	20	20	7/28	0.016	0.41	0.032	0.81	0.459	11.66
C9226A	25	20	7/28	0.016	0.41	0.032	0.81	0.506	12.85
C9227A*	2	18	16/30	0.016	0.41	0.032	0.81	0.254	6.45
C9228A	2	18	16/30	0.016	0.41	0.032	0.81	0.254	6.45
C9229A*	3	18	16/30	0.016	0.41	0.032	0.81	0.266	6.75
C9230A	3	18	16/30	0.016	0.41	0.032	0.81	0.266	6.75
C9231A	4	18	16/30	0.016	0.41	0.032	0.81	0.287	7.28
C9232A	6	18	16/30	0.016	0.41	0.032	0.81	0.332	8.43
C9233A	8	18	16/30	0.016	0.41	0.032	0.81	0.356	9.05
C9234A	10	18	16/30	0.016	0.41	0.032	0.81	0.410	10.41
C9235A	15	18	16/30	0.016	0.41	0.032	0.81	0.465	11.80
C9236A	20	18	16/30	0.016	0.41	0.032	0.81	0.512	13.01
C9237A	25	18	16/30	0.016	0.41	0.032	0.81	0.566	14.38
C9238A*	2	16	19/0117	0.016	0.41	0.032	0.81	0.274	6.96
C9239A	2	16	19/0117	0.016	0.41	0.032	0.81	0.274	6.96
C9240A*	3	16	19/0117	0.016	0.41	0.032	0.81	0.287	7.29
C9241A	3	16	19/0117	0.016	0.41	0.032	0.81	0.287	7.29
C9242A	4	16	19/0117	0.016	0.41	0.032	0.81	0.311	7.90
C9243A	6	16	19/0117	0.016	0.41	0.032	0.81	0.362	9.19
C9244A	8	16	19/0117	0.016	0.41	0.032	0.81	0.389	9.89
C9245A	10	16	19/0117	0.016	0.41	0.032	0.81	0.450	11.43
C9246A	15	16	19/0117	0.016	0.41	0.032	0.81	0.512	12.99
C9247A	20	16	19/0117	0.016	0.41	0.053	1.35	0.607	15.42
C9248A	25	16	19/0117	0.016	0.41	0.053	1.35	0.679	17.25

* IEC Color Code: Brown, Blue, Green/Yellow



EXZEL® Multi-Paired, Unshielded

UL 2464, NEC Type CM (UL), CSA CMG

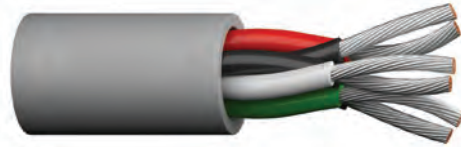

PART NUMBER	PAIRS	AWG SIZE	COND. STRAND	NOMINAL INSULATION THICKNESS		NOMINAL JACKET THICKNESS		NOMINAL CABLE DIAMETER	
				in	mm	in	mm	in	mm
C9300A	1	24	7/32	0.010	0.25	0.032	0.81	0.155	3.94
C9301A	2	24	7/32	0.010	0.25	0.032	0.81	0.211	5.37
C9302A	3	24	7/32	0.010	0.25	0.032	0.81	0.222	5.64
C9303A	4	24	7/32	0.010	0.25	0.032	0.81	0.242	6.13
C9304A	5	24	7/32	0.010	0.25	0.032	0.81	0.262	6.65
C9305A	6	24	7/32	0.010	0.25	0.032	0.81	0.283	7.20
C9306A	9	24	7/32	0.010	0.25	0.032	0.81	0.327	8.31
C9307A	11	24	7/32	0.010	0.25	0.032	0.81	0.355	9.03
C9308A	15	24	7/32	0.010	0.25	0.032	0.81	0.406	10.31
C9309A	1	22	7/30	0.010	0.25	0.032	0.81	0.149	3.79
C9310A	2	22	7/30	0.010	0.25	0.032	0.81	0.231	5.88
C9311A	3	22	7/30	0.010	0.25	0.032	0.81	0.244	6.19
C9312A	4	22	7/30	0.010	0.25	0.032	0.81	0.266	6.75
C9313A	5	22	7/30	0.010	0.25	0.032	0.81	0.289	7.34
C9314A	6	22	7/30	0.010	0.25	0.032	0.81	0.314	7.96
C9315A	15	22	7/30	0.010	0.25	0.032	0.81	0.453	11.51
C9316A	2	20	7/28	0.016	0.41	0.032	0.81	0.295	7.49
C9317A	3	20	7/28	0.016	0.41	0.032	0.81	0.312	7.93
C9318A	6	20	7/28	0.016	0.41	0.032	0.81	0.409	10.39
C9319A	9	20	7/28	0.016	0.41	0.032	0.81	0.479	12.16
C9320A	12	20	7/28	0.016	0.41	0.032	0.81	0.540	13.72
C9321A	2	18	16/30	0.016	0.41	0.032	0.81	0.329	8.35
C9322A	3	18	16/30	0.016	0.41	0.032	0.81	0.348	8.85
C9323A	6	18	16/30	0.016	0.41	0.032	0.81	0.459	11.67
C9324A	9	18	16/30	0.016	0.41	0.032	0.81	0.539	13.70
C9325A	12	18	16/30	0.016	0.41	0.053	1.35	0.652	16.56

Product Construction:

Conductor:

- Fully annealed stranded tinned copper per ASTM B33

Insulation:

- Premium-grade, color-coded PVC
- Color per Chart C for 24 AWG and 22 AWG on page 97
- Color per Chart D for 20 AWG and larger on page 97

Shield:

- Unshielded

Jacket:

- Premium PVC
- Operating temperature range: -30°C to +105°C (Type CM) -30°C to +80°C (AWM)

Applications:

- Advanced signal transmission in controlled environments
- Medical instrumentation and equipment
- Consumer electronic peripherals
- Industrial process control systems
- Suitable for EIA RS-232 applications

Features:

- Oil-resistant per UL Oil Res I and Class 43
- Sunlight-resistant
- Nylon ripcord

Compliances:

- NEC Article 800 Type CM (UL: 105°C)
- UL Style 2464 (UL: 80°C, 300 V, VW-1)
- CSA Type CMG (CSA: 105°C, FT4)
- RoHS Compliant Directive 2015/863/EU (RoHS-3)
- Vertical Tray Cable Flame Test per UL 1581 and IEEE 383 (70,000 BTU)

Packaging:

- Please contact Customer Service for packaging and color options
- Data subject to change.



EXZEL® Multi-Paired, Foil Shielded

UL 2464, NEC Type CM (UL), CSA CMG

Product Construction:

Conductor:

- Fully annealed stranded tinned copper per ASTM B33

Insulation:

- Premium-grade, color-coded PVC
- Color per Chart C for 24 AWG and 22 AWG on page 97
- Color per Chart D for 20 AWG and larger on page 97

Shield:

- 100% Flexfoil® aluminum/polyester, foil facing in
- Stranded tinned copper drain wire

Jacket:

- Premium PVC
- Operating temperature range: -30°C to +105°C (Type CM)
- -30°C to +80°C (AWM)

Applications:

- Advanced signal transmission in controlled environments
- Medical instrumentation and equipment
- Consumer electronic peripherals
- Industrial process control systems
- Suitable for EIA RS-232 applications

Features:

- Oil-resistant per UL Oil Res I and Class 43
- Sunlight-resistant
- Nylon ripcord

Compliances:

- NEC Article 800 Type CM (UL: 105°C)
- UL Style 2464 (UL: 80°C, 300 V, VW-1)
- CSA Type CMG (CSA: 105°C, FT4)
- RoHS Compliant Directive 2015/863/EU (RoHS-3)
- Vertical Tray Cable Flame Test per UL 1581 and IEEE 383 (70,000 BTU)

Packaging:

- Please contact Customer Service for packaging and color options
- Data subject to change.

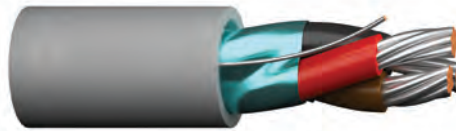

PART NUMBER	PAIRS	AWG SIZE	COND. STRAND	NOMINAL INSULATION THICKNESS		NOMINAL JACKET THICKNESS		NOMINAL CABLE DIAMETER	
				in	mm	in	mm	in	mm
C9400A	1	24	7/32	0.010	0.25	0.032	0.81	0.157	3.99
C9401A	2	24	7/32	0.010	0.25	0.032	0.81	0.215	5.47
C9402A	3	24	7/32	0.010	0.25	0.032	0.81	0.226	5.74
C9403A	4	24	7/32	0.010	0.25	0.032	0.81	0.246	6.24
C9404A	5	24	7/32	0.010	0.25	0.032	0.81	0.266	6.75
C9405A	6	24	7/32	0.010	0.25	0.032	0.81	0.287	7.30
C9406A	9	24	7/32	0.010	0.25	0.032	0.81	0.331	8.42
C9407A	11	24	7/32	0.010	0.25	0.032	0.81	0.359	9.13
C9408A	15	24	7/32	0.010	0.25	0.032	0.81	0.410	10.41
C9410A	1	22	7/30	0.010	0.25	0.032	0.81	0.169	4.29
C9411A	2	22	7/30	0.010	0.25	0.032	0.81	0.235	5.98
C9412A	3	22	7/30	0.010	0.25	0.032	0.81	0.248	6.29
C9413A	4	22	7/30	0.010	0.25	0.032	0.81	0.270	6.85
C9414A	5	22	7/30	0.010	0.25	0.032	0.81	0.293	7.44
C9415A	6	22	7/30	0.010	0.25	0.032	0.81	0.318	8.06
C9416A	9	22	7/30	0.010	0.25	0.032	0.81	0.368	9.34
C9417A	11	22	7/30	0.010	0.25	0.032	0.81	0.400	10.15
C9418A	15	22	7/30	0.010	0.25	0.032	0.81	0.457	11.61
C9420A	2	20	7/28	0.016	0.41	0.032	0.81	0.299	7.60
C9421A	3	20	7/28	0.016	0.41	0.032	0.81	0.316	8.03
C9422A	6	20	7/28	0.016	0.41	0.032	0.81	0.413	10.49
C9423A	9	20	7/28	0.016	0.41	0.032	0.81	0.483	12.26
C9424A	12	20	7/28	0.016	0.41	0.032	0.81	0.544	13.82
C9426A	3	18	16/30	0.016	0.41	0.032	0.81	0.352	8.95
C9427A	6	18	16/30	0.016	0.41	0.032	0.81	0.463	11.77



EXZEL® Multi-Paired, Foil/Braid Shielded

UL 2464, NEC Type CM (UL), CSA CMG



PART NUMBER	PAIRS	AWG SIZE	COND. STRAND	NOMINAL INSULATION THICKNESS		NOMINAL JACKET THICKNESS		NOMINAL CABLE DIAMETER	
				in	mm	in	mm	in	mm
C9500A	1	24	7/32	0.010	0.25	0.032	0.81	0.184	4.67
C9501A	2	24	7/32	0.010	0.25	0.032	0.81	0.242	6.10
C9502A	3	24	7/32	0.010	0.25	0.032	0.81	0.253	6.40
C9503A	4	24	7/32	0.010	0.25	0.032	0.81	0.273	6.88
C9504A	5	24	7/32	0.010	0.25	0.032	0.81	0.293	7.42
C9505A	6	24	7/32	0.010	0.25	0.032	0.81	0.314	7.98
C9506A	9	24	7/32	0.010	0.25	0.032	0.81	0.358	9.14
C9507A	11	24	7/32	0.010	0.25	0.032	0.81	0.386	9.78
C9508A	15	24	7/32	0.010	0.25	0.032	0.81	0.437	10.90
C9510A	1	22	7/30	0.010	0.25	0.032	0.81	0.196	4.98
C9511A	2	22	7/30	0.010	0.25	0.032	0.81	0.262	6.60
C9512A	3	22	7/30	0.010	0.25	0.032	0.81	0.275	6.93
C9513A	4	22	7/30	0.010	0.25	0.032	0.81	0.297	7.49
C9514A	5	22	7/30	0.010	0.25	0.032	0.81	0.320	8.10
C9515A	6	22	7/30	0.010	0.25	0.032	0.81	0.345	8.74
C9516A	9	22	7/30	0.010	0.25	0.032	0.81	0.395	10.06
C9517A	11	22	7/30	0.010	0.25	0.032	0.81	0.427	10.77
C9518A	15	22	7/30	0.010	0.25	0.032	0.81	0.484	12.07
C9520A	2	20	7/28	0.016	0.41	0.032	0.81	0.326	8.28
C9521A	3	20	7/28	0.016	0.41	0.032	0.81	0.343	8.74
C9522A	6	20	7/28	0.016	0.41	0.032	0.81	0.440	11.25
C9523A	9	20	7/28	0.016	0.41	0.032	0.81	0.510	13.08
C9525A	2	18	16/30	0.016	0.41	0.032	0.81	0.360	9.02
C9526A	3	18	16/30	0.016	0.41	0.032	0.81	0.379	9.55
C9527A	6	18	16/30	0.016	0.41	0.032	0.81	0.490	12.40
C9528A	9	18	16/30	0.016	0.41	0.053	1.35	0.612	15.52

Product Construction:

Conductor:

- Fully annealed stranded tinned copper per ASTM B33

Insulation:

- Premium-grade, color-coded PVC
- Color per Chart C for 24 AWG and 22 AWG on page 97
- Color per Chart D for 20 AWG and larger on page 97

Shield:

- Dual foil with overall braided shield
- Aluminum/polyester/aluminum foil with 100% coverage
- Stranded tinned copper drain wire
- Tinned copper braided shield, 70% min coverage

Jacket:

- Premium PVC
- Operating temperature range: -30°C to +105°C (Type CM) -30°C to +80°C (AWM)

Applications:

- Advanced signal transmission in controlled environments
- Medical instrumentation and equipment
- Consumer electronic peripherals
- Industrial process control systems
- Suitable for EIA RS-232 applications

Features:

- Oil-resistant per UL Oil Res I and Class 43
- Sunlight-resistant
- Nylon ripcord

Compliances:

- NEC Article 800 Type CM (UL: 105°C)
- UL Style 2464 (UL: 80°C, 300 V, VW-1)
- CSA Type CMG (CSA: 105°C, FT4)
- RoHS Compliant Directive 2015/863/EU (RoHS-3)
- Vertical Tray Cable Flame Test per UL 1581 and IEEE 383 (70,000 BTU)

Packaging:

- Please contact Customer Service for packaging and color options
- Data subject to change.



EXZEL® Multi-Conductor, Unshielded, Heavy Duty

UL 2343, NEC Type CM (UL), CSA CMG

Product Construction:

Conductor:

- Fully annealed stranded tinned copper per ASTM B33

Insulation:

- Premium-grade, color-coded PVC
- Color per Chart A on page 97

Shield:

- Unshielded

Jacket:

- Premium PVC
- Operating temperature range:
-30°C to +105°C (Type CM)
-30°C to +80°C (AWM)

Applications:

- Advanced signal transmission in controlled environments
- Medical instrumentation and equipment
- Consumer electronic peripherals
- Industrial process control systems
- Suitable for EIA RS-232 applications

Features:

- Oil-resistant per UL Oil Res I and Class 43
- Sunlight-resistant
- Nylon ripcord

Compliances:

- NEC Article 800 Type CM (UL: 105°C)
- UL Style 2343 (UL: 80°C, VW-1)
- CSA Type CMG (CSA: 105°C, FT4)
- RoHS Compliant Directive 2015/863/EU (RoHS-3)
- Vertical Tray Cable Flame Test per UL 1581 and IEEE 383 (70,000 BTU)

Packaging:

- Please contact Customer Service for packaging and color options
- Data subject to change.

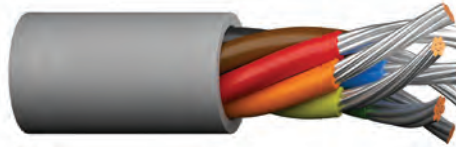

PART NUMBER	COND.	AWG SIZE	COND. STRAND	NOMINAL INSULATION THICKNESS		NOMINAL JACKET THICKNESS		NOMINAL CABLE DIAMETER	
				in	mm	in	mm	in	mm
C9058A	7	24	7/32	0.010	0.25	0.063	1.6	0.260	6.60
C9059A	12	24	7/32	0.010	0.25	0.063	1.6	0.309	7.86
C9060A	15	24	7/32	0.010	0.25	0.063	1.6	0.333	8.46
C9061A	19	24	7/32	0.010	0.25	0.063	1.6	0.346	8.79
C9062A	2	22	7/30	0.010	0.25	0.063	1.6	0.229	5.82
C9063A	7	22	7/30	0.010	0.25	0.063	1.6	0.278	7.06
C9064A	12	22	7/30	0.010	0.25	0.063	1.6	0.334	8.49
C9065A	15	22	7/30	0.010	0.25	0.063	1.6	0.361	9.18
C9066A	19	22	7/30	0.010	0.25	0.063	1.6	0.376	9.55
C9067A	25	22	7/30	0.010	0.25	0.063	1.6	0.425	10.80
C9068A	2	20	7/28	0.010	0.25	0.063	1.6	0.243	6.17
C9069A	5	20	7/28	0.010	0.25	0.063	1.6	0.282	7.17
C9070A	7	20	7/28	0.010	0.25	0.063	1.6	0.299	7.59
C9071A	12	20	7/28	0.010	0.25	0.063	1.6	0.363	9.23
C9072A	15	20	7/28	0.010	0.25	0.063	1.6	0.394	10.01
C9073A	19	20	7/28	0.010	0.25	0.063	1.6	0.411	10.44
C9074A	25	20	7/28	0.010	0.25	0.063	1.6	0.467	11.86



EXZEL® Multi-Conductor, Foil Shielded, Heavy Duty

UL 2343, NEC Type CM (UL), CSA CMG

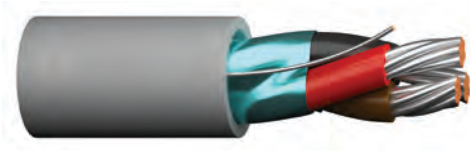

Product Construction:

Conductor:

- Fully annealed stranded tinned copper per ASTM B33

Insulation:

- Premium-grade, color-coded PVC
- Color per Chart A on page 97

Shield:

- 100% Flexfoil® aluminum/polyester, foil facing in
- Stranded tinned copper drain wire

Jacket:

- Premium PVC
- Operating temperature range: -30°C to +105°C (Type CM) -30°C to +80°C (AWM)

Applications:

- Advanced signal transmission in controlled environments
- Medical instrumentation and equipment
- Consumer electronic peripherals
- Industrial process control systems
- Suitable for EIA RS-232 applications

Features:

- Oil-resistant per UL Oil Res I and Class 43
- Sunlight-resistant
- Nylon ripcord

Compliances:

- NEC Article 800 Type CM (UL: 105°C)
- UL Style 2343 (UL: 80°C, VW-1)
- CSA Type CMG (CSA: 105°C, FT4)
- RoHS Compliant Directive 2015/863/EU (RoHS-3)
- Vertical Tray Cable Flame Test per UL 1581 and IEEE 383 (70,000 BTU)

Packaging:

- Please contact Customer Service for packaging and color options
- Data subject to change.

PART NUMBER	COND.	AWG SIZE	COND. STRAND	NOMINAL INSULATION THICKNESS		NOMINAL JACKET THICKNESS		NOMINAL CABLE DIAMETER	
				in	mm	in	mm	in	mm
C9158A	3	24	7/32	0.010	0.25	0.063	1.6	0.225	5.73
C9159A	5	24	7/32	0.010	0.25	0.063	1.6	0.249	6.33
C9160A	7	24	7/32	0.010	0.25	0.063	1.6	0.262	6.65
C9161A	12	24	7/32	0.010	0.25	0.063	1.6	0.311	7.91
C9162A	15	24	7/32	0.010	0.25	0.063	1.6	0.335	8.51
C9163A	19	24	7/32	0.010	0.25	0.063	1.6	0.348	8.84
C9164A	2	22	7/30	0.010	0.25	0.063	1.6	0.231	5.87
C9165A	5	22	7/30	0.010	0.25	0.063	1.6	0.265	6.74
C9166A	7	22	7/30	0.010	0.25	0.063	1.6	0.280	7.11
C9167A	12	22	7/30	0.010	0.25	0.063	1.6	0.336	8.54
C9168A	15	22	7/30	0.010	0.25	0.063	1.6	0.363	9.23
C9169A	19	22	7/30	0.010	0.25	0.063	1.6	0.378	9.60
C9170A	2	20	7/28	0.010	0.25	0.063	1.6	0.245	6.22
C9171A	5	20	7/28	0.010	0.25	0.063	1.6	0.284	7.22
C9172A	7	20	7/28	0.010	0.25	0.063	1.6	0.301	7.65
C9173A	12	20	7/28	0.010	0.25	0.063	1.6	0.365	9.28
C9174A	15	20	7/28	0.010	0.25	0.063	1.6	0.396	10.06
C9175A	19	20	7/28	0.010	0.25	0.063	1.6	0.413	10.49



EXZEL® Multi-Conductor, Foil/Braid Shielded, Heavy Duty

UL 2343, NEC Type CM (UL), CSA CMG

Product Construction:

Conductor:

- Fully annealed stranded tinned copper per ASTM B33

Insulation:

- Premium-grade, color-coded PVC
- Color per Chart A on page 97

Shield:

- Dual foil with overall braided shield
- Aluminum/polyester/aluminum foil with 100% coverage
- Stranded tinned copper drain wire
- Tinned copper braided shield, 70% min coverage

Jacket:

- Premium PVC
- Operating temperature range: -30°C to +105°C (Type CM) -30°C to +80°C (AWM)

Applications:

- Advanced signal transmission in controlled environments
- Medical instrumentation and equipment
- Consumer electronic peripherals
- Industrial process control systems
- Suitable for EIA RS-232 applications

Features:

- Oil-resistant per UL Oil Res I and Class 43
- Sunlight-resistant
- Nylon ripcord

Compliances:

- NEC Article 800 Type CM (UL: 105°C)
- UL Style 2343 (UL: 80°C, VW-1)
- CSA Type CMG (CSA: 105°C, FT4)
- RoHS Compliant Directive 2015/863/EU (RoHS-3)
- Vertical Tray Cable Flame Test per UL 1581 and IEEE 383 (70,000 BTU)

Packaging:

- Please contact Customer Service for packaging and color options
- Data subject to change.



PART NUMBER	COND.	AWG SIZE	COND. STRAND	NOMINAL INSULATION THICKNESS		NOMINAL JACKET THICKNESS		NOMINAL CABLE DIAMETER	
				in	mm	in	mm	in	mm
C9258A	5	24	7/32	0.010	0.25	0.063	1.6	0.276	7.01
C9259A	7	24	7/32	0.010	0.25	0.063	1.6	0.289	7.34
C9260A	12	24	7/32	0.010	0.25	0.063	1.6	0.338	8.60
C9261A	15	24	7/32	0.010	0.25	0.063	1.6	0.362	9.20
C9262A	19	24	7/32	0.010	0.25	0.063	1.6	0.375	9.53
C9263A	5	22	7/30	0.010	0.25	0.063	1.6	0.292	7.42
C9264A	7	22	7/30	0.010	0.25	0.063	1.6	0.307	7.80
C9265A	12	22	7/30	0.010	0.25	0.063	1.6	0.363	9.23
C9266A	15	22	7/30	0.010	0.25	0.063	1.6	0.390	9.91
C9267A	19	22	7/30	0.010	0.25	0.063	1.6	0.405	10.29
C9268A	4	20	7/28	0.010	0.25	0.063	1.6	0.296	7.51
C9269A	5	20	7/28	0.010	0.25	0.063	1.6	0.311	7.90
C9270A	7	20	7/28	0.010	0.25	0.063	1.6	0.328	8.33
C9271A	12	20	7/28	0.010	0.25	0.063	1.6	0.392	9.97
C9272A	15	20	7/28	0.010	0.25	0.063	1.6	0.423	10.75
C9273A	19	20	7/28	0.010	0.25	0.063	1.6	0.440	11.18

EXZEL® Multi-Paired, Foil/Braid Shielded, Heavy Duty

UL 2343, NEC Type CM (UL), CSA CMG



PART NUMBER	PAIRS	AWG SIZE	COND. STRAND	NOMINAL INSULATION THICKNESS		NOMINAL JACKET THICKNESS		NOMINAL CABLE DIAMETER	
				in	mm	in	mm	in	mm
C9538A	5	24	7/32	0.010	0.25	0.063	1.6	0.355	9.01
C9539A	7	24	7/32	0.010	0.25	0.063	1.6	0.376	9.56
C9540A	12	24	7/32	0.010	0.25	0.063	1.6	0.459	11.67
C9541A	15	24	7/32	0.010	0.25	0.063	1.6	0.499	12.67
C9543A	2	22	7/30	0.010	0.25	0.063	1.6	0.324	8.24
C9544A	5	22	7/30	0.010	0.25	0.063	1.6	0.382	9.70
C9545A	7	22	7/30	0.010	0.25	0.063	1.6	0.407	10.33
C9546A	12	22	7/30	0.010	0.25	0.063	1.6	0.501	12.73
C9548A	4	20	7/28	0.010	0.25	0.063	1.6	0.387	9.84
C9549A	5	20	7/28	0.010	0.25	0.063	1.6	0.414	10.50
C9550A	7	20	7/28	0.010	0.25	0.063	1.6	0.442	11.22
C9551A	9	20	7/28	0.010	0.25	0.063	1.6	0.499	12.68
C9552A	15	20	7/28	0.010	0.25	0.063	1.6	0.601	15.28

Product Construction:

Conductor:

- Fully annealed stranded tinned copper per ASTM B33

Insulation:

- Premium-grade, color-coded PVC
- Color per Chart C on page 97

Shield:

- Dual foil with overall braided shield
- Aluminum/polyester/aluminum foil with 100% coverage
- Stranded tinned copper drain wire
- Tinned copper braided shield, 70% min coverage

Jacket:

- Premium PVC
- Operating temperature range: -30°C to +105°C

Applications:

- Advanced signal transmission in controlled environments
- Medical instrumentation and equipment
- Consumer electronic peripherals
- Industrial process control systems
- Suitable for EIA RS-232 applications

Features:

- Oil-resistant per UL Oil Res I and Class 43
- Sunlight-resistant
- Nylon ripcord

Compliances:

- NEC Article 800 Type CM (UL: 105°C)
- UL Style 2343 (UL: 80°C, VW-1)
- CSA Type CMG (CSA: 105°C, FT4)
- RoHS Compliant Directive 2015/863/EU (RoHS-3)
- Vertical Tray Cable Flame Test per UL 1581 and IEEE 383 (70,000 BTU)

Packaging:

- Please contact Customer Service for packaging and color options
- Data subject to change.



EXZEL® LSZH Multi-Conductor, Unshielded

NEC Type CM, CMG, CL2 or PLTC-ER (UL)

Product Construction:

Conductor:

- Fully annealed stranded tinned copper per ASTM B33

Insulation:

- Premium-grade, color-coded LSZH
- Color per Chart A for 24 AWG and 22 AWG on page 97
- Color per Chart B for 20 AWG and larger on page 97
- International colors per IEC Color Chart on page 97

Shield:

- Unshielded

Jacket:

- Premium FR-LSZH (Thermoplastic Polyolefin)
- Operating temperature range: -40°C to +105°C

Applications:

- Advanced signal transmission in controlled environments
- Medical instrumentation and equipment
- Consumer electronic peripherals
- Industrial process control systems
- Suitable for EIA RS-232 applications

Features:

- Oil-resistant (OIL RES I)
- Sunlight-resistant (SUN RES)
- Nylon ripcord
- UV-resistant

Compliances:

- NEC Article 725 Type PLTC-ER (22 AWG and larger, UL: 105°C, 300 V)
- (-ER): approved for Exposed Run as defined per NEC Article 725
- NEC Article 725 Type CL2 (UL: 105°C, 150 V)
- NEC Article 800 Type CM/CMG (UL: 105°C, 300 V)
- RoHS Compliant Directive 2015/863/EU (RoHS-3)

Compliances: Flame & Smoke

- Vertical Tray Cable Flame Test per UL 1581 and IEEE 383 (70,000 BTU)
- CSA FT4/IEEE 1202 flame test per UL 1685
- IEC 60332-1, 3, Cat A: Flammability
- IEC 61034-1, 2 and Mil-DTL-24643B and NES 711: Smoke Index Emission
- IEC 60754-1, 2 and Mil-DTL-24643B: Halogen Content and Acid Gas Generation

Packaging:

- Please contact Customer Service for packaging and color options
- Data subject to change.

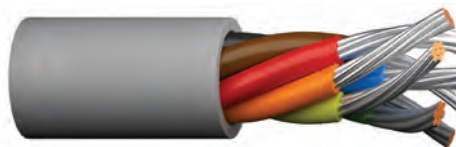

PART NUMBER	COND.	AWG SIZE	COND. STRAND	NOMINAL INSULATION THICKNESS		NOMINAL JACKET THICKNESS		NOMINAL CABLE DIAMETER	
				in	mm	in	mm	in	mm
C9000ZH	2	24	7/32	0.010	0.25	0.032	0.81	0.160	4.06
C9001ZH	3	24	7/32	0.010	0.25	0.032	0.81	0.167	4.23
C9002ZH	4	24	7/32	0.010	0.25	0.032	0.81	0.178	4.53
C9003ZH	6	24	7/32	0.010	0.25	0.032	0.81	0.204	5.18
C9004ZH	8	24	7/32	0.010	0.25	0.032	0.81	0.218	5.53
C9005ZH	10	24	7/32	0.010	0.25	0.032	0.81	0.248	6.30
C9006ZH	15	24	7/32	0.010	0.25	0.037	0.94	0.289	7.34
C9007ZH	20	24	7/32	0.010	0.25	0.037	0.94	0.316	8.02
C9008ZH	25	24	7/32	0.010	0.25	0.037	0.94	0.346	8.79
C9009ZH	2	22	7/30	0.013	0.33	0.037	0.94	0.182	4.62
C9010ZH	3	22	7/30	0.013	0.33	0.037	0.94	0.190	4.81
C9011ZH	4	22	7/30	0.013	0.33	0.037	0.94	0.203	5.16
C9012ZH	6	22	7/30	0.013	0.33	0.037	0.94	0.232	5.89
C9013ZH	8	22	7/30	0.013	0.33	0.037	0.94	0.248	6.29
C9014ZH	10	22	7/30	0.013	0.33	0.042	1.07	0.292	7.42
C9015ZH	15	22	7/30	0.013	0.33	0.042	1.07	0.327	8.31
C9016ZH	20	22	7/30	0.013	0.33	0.042	1.07	0.358	9.08
C9017ZH	25	22	7/30	0.013	0.33	0.052	1.32	0.412	10.46
C9018ZH	2	20	7/28	0.016	0.41	0.037	0.94	0.222	5.64
C9019ZH	3	20	7/28	0.016	0.41	0.037	0.94	0.233	5.91
C9020ZH	4	20	7/28	0.016	0.41	0.037	0.94	0.251	6.39
C9021ZH	6	20	7/28	0.016	0.41	0.042	1.07	0.302	7.67
C9022ZH	8	20	7/28	0.016	0.41	0.042	1.07	0.324	8.22
C9023ZH	10	20	7/28	0.016	0.41	0.042	1.07	0.372	9.45
C9024ZH	15	20	7/28	0.016	0.41	0.052	1.32	0.441	11.20
C9025ZH	20	20	7/28	0.016	0.41	0.052	1.32	0.484	12.29
C9026ZH	25	20	7/28	0.016	0.41	0.052	1.32	0.532	13.51
C9027ZH*	2	18	16/30	0.016	0.41	0.037	0.94	0.238	6.05
C9028ZH*	2	18	16/30	0.016	0.41	0.037	0.94	0.238	6.05
C9029ZH*	3	18	16/30	0.016	0.41	0.037	0.94	0.250	6.34
C9030ZH	3	18	16/30	0.016	0.41	0.037	0.94	0.250	6.34
C9031ZH	4	18	16/30	0.016	0.41	0.037	0.94	0.271	6.88
C9032ZH	6	18	16/30	0.016	0.41	0.042	1.07	0.326	8.28
C9033ZH	8	18	16/30	0.016	0.41	0.042	1.07	0.350	8.89
C9034ZH	10	18	16/30	0.016	0.41	0.052	1.32	0.424	10.77
C9035ZH	15	18	16/30	0.016	0.41	0.052	1.32	0.479	12.16
C9036ZH	20	18	16/30	0.016	0.41	0.052	1.32	0.526	13.36
C9037ZH	25	18	16/30	0.016	0.41	0.052	1.32	0.580	14.73
C9038ZH*	2	16	19/0117	0.016	0.41	0.037	0.94	0.262	6.65
C9039ZH	2	16	19/0117	0.016	0.41	0.037	0.94	0.262	6.65
C9040ZH*	3	16	19/0117	0.016	0.41	0.037	0.94	0.276	7.00
C9041ZH	3	16	19/0117	0.016	0.41	0.037	0.94	0.276	7.00
C9042ZH	4	16	19/0117	0.016	0.41	0.042	1.07	0.310	7.87
C9043ZH	6	16	19/0117	0.016	0.41	0.042	1.07	0.362	9.19
C9044ZH	8	16	19/0117	0.016	0.41	0.052	1.32	0.410	10.41
C9045ZH	10	16	19/0117	0.016	0.41	0.052	1.32	0.472	11.99
C9046ZH	15	16	19/0117	0.016	0.41	0.052	1.32	0.535	13.59
C9047ZH	20	16	19/0117	0.016	0.41	0.052	1.32	0.590	14.98
C9048ZH	25	16	19/0117	0.016	0.41	0.062	1.57	0.672	17.07

* IEC Color Code: Brown, Blue, Green/Yellow.

EXZEL® LSZH Multi-Conductor, Foil Shielded

NEC Type CM, CMG, CL2 or PLTC-ER (UL)

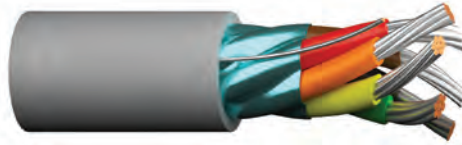

PART NUMBER	COND.	AWG SIZE	COND. STRAND	NOMINAL INSULATION THICKNESS		NOMINAL JACKET THICKNESS		NOMINAL CABLE DIAMETER	
				in	mm	in	mm	in	mm
C9100ZH	2	24	7/32	0.010	0.25	0.032	0.81	0.165	4.19
C9101ZH	3	24	7/32	0.010	0.25	0.032	0.81	0.172	4.36
C9102ZH	4	24	7/32	0.010	0.25	0.032	0.81	0.183	4.66
C9103ZH	6	24	7/32	0.010	0.25	0.032	0.81	0.209	5.31
C9104ZH	8	24	7/32	0.010	0.25	0.032	0.81	0.223	5.66
C9105ZH	10	24	7/32	0.010	0.25	0.032	0.81	0.253	6.43
C9106ZH	15	24	7/32	0.010	0.25	0.037	0.94	0.294	7.46
C9107ZH	20	24	7/32	0.010	0.25	0.037	0.94	0.321	8.14
C9108ZH	25	24	7/32	0.010	0.25	0.037	0.94	0.351	8.92
C9109ZH	2	22	7/30	0.013	0.33	0.037	0.94	0.187	4.75
C9110ZH	3	22	7/30	0.013	0.33	0.037	0.94	0.195	4.94
C9111ZH	4	22	7/30	0.013	0.33	0.037	0.94	0.208	5.28
C9112ZH	6	22	7/30	0.013	0.33	0.037	0.94	0.237	6.02
C9113ZH	8	22	7/30	0.013	0.33	0.037	0.94	0.253	6.41
C9114ZH	10	22	7/30	0.013	0.33	0.042	1.07	0.297	7.54
C9115ZH	15	22	7/30	0.013	0.33	0.042	1.07	0.332	8.43
C9116ZH	20	22	7/30	0.013	0.33	0.042	1.07	0.363	9.21
C9117ZH	25	22	7/30	0.013	0.33	0.052	1.32	0.417	10.59
C9118ZH	2	20	7/28	0.016	0.41	0.037	0.94	0.227	5.77
C9119ZH	3	20	7/28	0.016	0.41	0.037	0.94	0.238	6.03
C9120ZH	4	20	7/28	0.016	0.41	0.037	0.94	0.256	6.51
C9121ZH	6	20	7/28	0.016	0.41	0.042	1.07	0.307	7.80
C9122ZH	8	20	7/28	0.016	0.41	0.042	1.07	0.329	8.35
C9123ZH	10	20	7/28	0.016	0.41	0.042	1.07	0.377	9.58
C9124ZH	15	20	7/28	0.016	0.41	0.052	1.32	0.446	11.33
C9125ZH	20	20	7/28	0.016	0.41	0.052	1.32	0.489	12.41
C9126ZH	25	20	7/28	0.016	0.41	0.052	1.32	0.537	13.64
C9127ZH	2	18	16/30	0.016	0.41	0.037	0.94	0.243	6.17
C9128ZH*	2	18	16/30	0.016	0.41	0.037	0.94	0.243	6.17
C9129ZH	3	18	16/30	0.016	0.41	0.037	0.94	0.255	6.47
C9130ZH*	3	18	16/30	0.016	0.41	0.037	0.94	0.255	6.47
C9131ZH	4	18	16/30	0.016	0.41	0.037	0.94	0.276	7.00
C9132ZH	6	18	16/30	0.016	0.41	0.042	1.07	0.331	8.41
C9133ZH	8	18	16/30	0.016	0.41	0.042	1.07	0.355	9.02
C9134ZH	10	18	16/30	0.016	0.41	0.052	1.32	0.429	10.90
C9135ZH	15	18	16/30	0.016	0.41	0.052	1.32	0.484	12.28
C9136ZH	20	18	16/30	0.016	0.41	0.052	1.32	0.531	13.49
C9137ZH	25	18	16/30	0.016	0.41	0.052	1.32	0.585	14.86
C9138ZH	2	16	19/0117	0.016	0.41	0.037	0.94	0.267	6.78
C9139ZH*	2	16	19/0117	0.016	0.41	0.037	0.94	0.267	6.78
C9140ZH	3	16	19/0117	0.016	0.41	0.037	0.94	0.281	7.12
C9141ZH*	3	16	19/0117	0.016	0.41	0.037	0.94	0.281	7.12
C9142ZH	4	16	19/0117	0.016	0.41	0.042	1.07	0.315	8.00
C9143ZH	6	16	19/0117	0.016	0.41	0.042	1.07	0.367	9.32
C9144ZH	8	16	19/0117	0.016	0.41	0.052	1.32	0.415	10.54
C9145ZH	10	16	19/0117	0.016	0.41	0.052	1.32	0.477	12.12
C9146ZH	15	16	19/0117	0.016	0.41	0.052	1.32	0.540	13.72
C9147ZH	20	16	19/0117	0.016	0.41	0.052	1.32	0.595	15.11
C9148ZH	25	16	19/0117	0.016	0.41	0.062	1.57	0.677	17.20

* IEC Color Code: Brown, Blue, Green/Yellow.

Product Construction:

Conductor:

- Fully annealed stranded tinned copper per ASTM B33

Insulation:

- Premium-grade, color-coded LSZH (Thermoplastic Polyolefin)
- Color per Chart A for 24 AWG and 22 AWG on page 97
- Color per Chart B for 20 AWG and larger on page 97
- International colors per IEC Color Chart on page 97

Shield:

- 100% Flexfoil®, aluminum/polyester/aluminum, foil facing in
- Stranded tinned copper drain wire

Jacket:

- Premium FR-LSZH (Thermoplastic Polyolefin)
- Operating temperature range: -40°C to +105°C

Applications:

- Advanced signal transmission in controlled environments
- Medical instrumentation and equipment
- Consumer electronic peripherals
- Industrial process control systems
- Suitable for EIA RS-232 applications

Features:

- Oil-resistant (OIL RES I)
- Sunlight-resistant (SUN RES)
- Nylon ripcord
- UV-resistant

Compliances:

- NEC Article 725 Type PLTC-ER (22 AWG and larger, UL: 105°C, 300 V)
- (-ER): approved for Exposed Run as defined per NEC Article 725
- NEC Article 725 Type CL2 (UL: 105°C, 150 V)
- NEC Article 800 Type CM/CMG (UL: 105°C, 300 V)
- RoHS Compliant Directive 2015/863/EU (RoHS-3)

Compliances: Flame & Smoke

- Vertical Tray Cable Flame Test per UL 1581 and IEEE 383 (70,000 BTU)
- CSA FT4/IEEE 1202 flame test per UL 1685
- IEC 60332-1, 3, Cat A: Flammability
- IEC 61034-1, 2 and Mil-DTL-24643B and NES 711: Smoke Index Emission
- IEC 60754-1, 2 and Mil-DTL-24643B: Halogen Content and Acid Gas Generation

Packaging

- Please contact Customer Service for packaging and color options
- Data subject to change.



EXZEL® LSZH Multi-Conductor, Foil/Braid Shielded

NEC Type CM, CMG, CL2 or PLTC-ER (UL)

Product Construction:

Conductor:

- Full annealed stranded tinned copper per ASTM B33

Insulation:

- Premium-grade, color-coded LSZH (Thermoplastic Polyolefin)
- Color per Chart A for 24 AWG and 22 AWG on page 97
- Color per Chart B for 20 AWG and larger on page 97
- International colors per IEC Color Chart on page 97

Shield:

- Dual foil with overall braided shield
- Aluminum/polyester/aluminum foil with 100% coverage
- Stranded tinned copper drain wire
- Tinned copper braided shield, 85% min. coverage

Jacket:

- Premium FR-LSZH (Thermoplastic Polyolefin)
- Operating temperature range: -40°C to +105°C

Applications:

- Advanced signal transmission in controlled environments
- Medical instrumentation and equipment
- Consumer electronic peripherals
- Industrial process control systems
- Suitable for EIA RS-232 applications

Features:

- Oil-resistant (OIL RES I)
- Sunlight-resistant (SUN RES)
- Nylon ripcord
- UV-resistant

Compliances:

- NEC Article 725 Type PLTC-ER (22 AWG and larger, UL: 105°C, 300 V)
- (-ER): approved for Exposed Run as defined per NEC Article 725
- NEC Article 725 Type CL2 (UL: 105°C, 150 V)
- NEC Article 800 Type CM/CMG (UL: 105°C, 300 V)
- RoHS Compliant Directive 2015/863/EU (RoHS-3)

Compliances: Flame & Smoke

- Vertical Tray Cable Flame Test per UL 1581 and IEEE 383 (70,000 BTU)
- CSA FT4/IEEE 1202 flame test per UL 1685
- IEC 60332-1, 3, Cat A: Flammability
- IEC 61034-1, 2 and Mil-DTL-24643B and NES 711: Smoke Index Emission
- IEC 60754-1, 2 and Mil-DTL-24643B: Halogen Content and Acid Gas Generation

Packaging:

- Please contact Customer Service for packaging and color options
- Data subject to change.



PART NUMBER	COND.	AWG SIZE	COND. STRAND	NOMINAL INSULATION THICKNESS		NOMINAL JACKET THICKNESS		NOMINAL CABLE DIAMETER	
				in	mm	in	mm	in	mm
C9200ZH	2	24	7/32	0.010	0.25	0.032	0.81	0.187	4.75
C9201ZH	3	24	7/32	0.010	0.25	0.032	0.81	0.194	4.92
C9202ZH	4	24	7/32	0.010	0.25	0.032	0.81	0.205	5.22
C9203ZH	6	24	7/32	0.010	0.25	0.032	0.81	0.231	5.87
C9204ZH	8	24	7/32	0.010	0.25	0.032	0.81	0.245	6.21
C9205ZH	10	24	7/32	0.010	0.25	0.037	0.94	0.285	7.24
C9206ZH	15	24	7/32	0.010	0.25	0.037	0.94	0.316	8.02
C9207ZH	20	24	7/32	0.010	0.25	0.037	0.94	0.343	8.70
C9208ZH	25	24	7/32	0.010	0.25	0.037	0.94	0.373	9.47
C9209ZH	2	22	7/30	0.013	0.33	0.037	0.94	0.209	5.31
C9210ZH	3	22	7/30	0.013	0.33	0.037	0.94	0.217	5.50
C9211ZH	4	22	7/30	0.013	0.33	0.037	0.94	0.230	5.84
C9212ZH	6	22	7/30	0.013	0.33	0.037	0.94	0.259	6.58
C9213ZH	8	22	7/30	0.013	0.33	0.037	0.94	0.275	6.97
C9214ZH	10	22	7/30	0.013	0.33	0.042	1.07	0.319	8.10
C9215ZH	15	22	7/30	0.013	0.33	0.042	1.07	0.354	8.99
C9216ZH	20	22	7/30	0.013	0.33	0.042	1.07	0.385	9.77
C9217ZH	25	22	7/30	0.013	0.33	0.052	1.32	0.444	11.28
C9218ZH	2	20	7/28	0.016	0.41	0.037	0.94	0.249	6.32
C9219ZH	3	20	7/28	0.016	0.41	0.037	0.94	0.260	6.59
C9220ZH	4	20	7/28	0.016	0.41	0.037	0.94	0.278	7.07
C9221ZH	6	20	7/28	0.016	0.41	0.042	1.07	0.329	8.36
C9222ZH	8	20	7/28	0.016	0.41	0.042	1.07	0.351	8.91
C9223ZH	10	20	7/28	0.016	0.41	0.052	1.32	0.419	10.64
C9224ZH	15	20	7/28	0.016	0.41	0.052	1.32	0.473	12.01
C9225ZH	20	20	7/28	0.016	0.41	0.052	1.32	0.516	13.10
C9226ZH	25	20	7/28	0.016	0.41	0.052	1.32	0.564	14.33
C9227ZH*	2	18	16/30	0.016	0.41	0.037	0.94	0.265	6.73
C9228ZH	2	18	16/30	0.016	0.41	0.037	0.94	0.265	6.73
C9229ZH*	3	18	16/30	0.016	0.41	0.037	0.94	0.277	7.03
C9230ZH	3	18	16/30	0.016	0.41	0.037	0.94	0.277	7.03
C9231ZH	4	18	16/30	0.016	0.41	0.042	1.07	0.308	7.82
C9232ZH	6	18	16/30	0.016	0.41	0.042	1.07	0.353	8.97
C9233ZH	8	18	16/30	0.016	0.41	0.042	1.07	0.377	9.58
C9234ZH	10	18	16/30	0.016	0.41	0.052	1.32	0.456	11.58
C9235ZH	15	18	16/30	0.016	0.41	0.052	1.32	0.511	12.97
C9236ZH	20	18	16/30	0.016	0.41	0.052	1.32	0.558	14.18
C9237ZH	25	18	16/30	0.016	0.41	0.062	1.57	0.632	16.05
C9238ZH*	2	16	19/0117	0.016	0.41	0.042	1.07	0.299	7.59
C9239ZH	2	16	19/0117	0.016	0.41	0.042	1.07	0.299	7.59
C9240ZH*	3	16	19/0117	0.016	0.41	0.042	1.07	0.313	7.94
C9241ZH	3	16	19/0117	0.016	0.41	0.042	1.07	0.313	7.94
C9242ZH	4	16	19/0117	0.016	0.41	0.042	1.07	0.337	8.55
C9243ZH	6	16	19/0117	0.016	0.41	0.052	1.32	0.409	10.39
C9244ZH	8	16	19/0117	0.016	0.41	0.052	1.32	0.437	11.10
C9245ZH	10	16	19/0117	0.016	0.41	0.052	1.32	0.504	12.80
C9246ZH	15	16	19/0117	0.016	0.41	0.052	1.32	0.567	14.40
C9247ZH	20	16	19/0117	0.016	0.41	0.062	1.57	0.642	16.30
C9248ZH	25	16	19/0117	0.016	0.41	0.062	1.57	0.704	17.88

* IEC Color Code: Brown, Blue, Green/Yellow



EXZEL® LSZH Multi-Paired, Unshielded

NEC Type CM, CMG, CL2 or PLTC-ER (UL)

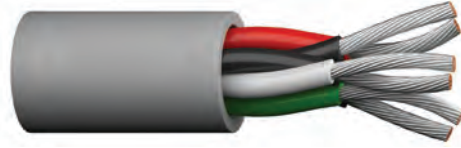

PART NUMBER	PAIRS	AWG SIZE	COND. STRAND	NOMINAL INSULATION THICKNESS		NOMINAL JACKET THICKNESS		NOMINAL CABLE DIAMETER	
				in	mm	in	mm	in	mm
C9300ZH	1	24	7/32	0.010	0.25	0.032	0.81	0.160	4.06
C9301ZH	2	24	7/32	0.010	0.25	0.032	0.81	0.220	5.58
C9302ZH	3	24	7/32	0.010	0.25	0.032	0.81	0.231	5.87
C9303ZH	4	24	7/32	0.010	0.25	0.032	0.81	0.251	6.37
C9304ZH	5	24	7/32	0.010	0.25	0.037	0.94	0.282	7.15
C9305ZH	6	24	7/32	0.010	0.25	0.037	0.94	0.304	7.72
C9306ZH	9	24	7/32	0.010	0.25	0.037	0.94	0.350	8.88
C9307ZH	11	24	7/32	0.010	0.25	0.037	0.94	0.378	9.59
C9308ZH	15	24	7/32	0.010	0.25	0.047	1.19	0.449	11.42
C9309ZH	1	22	7/30	0.013	0.33	0.037	0.94	0.182	4.62
C9310ZH	2	22	7/30	0.013	0.33	0.037	0.94	0.250	6.35
C9311ZH	3	22	7/30	0.013	0.33	0.037	0.94	0.263	6.67
C9312ZH	4	22	7/30	0.013	0.33	0.042	1.07	0.295	7.50
C9313ZH	5	22	7/30	0.013	0.33	0.042	1.07	0.319	8.10
C9314ZH	6	22	7/30	0.013	0.33	0.042	1.07	0.344	8.74
C9326ZH	9	22	7/30	0.013	0.33	0.052	1.32	0.416	10.57
C9327ZH	12	22	7/30	0.013	0.33	0.052	1.32	0.461	11.70
C9315ZH	15	22	7/30	0.013	0.33	0.052	1.32	0.507	12.87
C9328ZH	1	20	7/28	0.016	0.41	0.037	0.94	0.222	5.64
C9316ZH	2	20	7/28	0.016	0.41	0.042	1.07	0.327	8.31
C9317ZH	3	20	7/28	0.016	0.41	0.042	1.07	0.345	8.76
C9329ZH	4	20	7/28	0.016	0.41	0.042	1.07	0.377	9.57
C9330ZH	5	20	7/28	0.016	0.41	0.052	1.32	0.430	10.91
C9318ZH	6	20	7/28	0.016	0.41	0.052	1.32	0.465	11.81
C9319ZH	9	20	7/28	0.016	0.41	0.052	1.32	0.538	13.66
C9320ZH	12	20	7/28	0.016	0.41	0.052	1.32	0.600	15.24
C9331ZH	15	20	7/28	0.016	0.41	0.062	1.57	0.685	17.39
C9332ZH	1	18	16/30	0.016	0.41	0.037	0.94	0.238	6.05
C9321ZH	2	18	16/30	0.016	0.41	0.042	1.07	0.354	8.99
C9322ZH	3	18	16/30	0.016	0.41	0.042	1.07	0.374	9.49
C9333ZH	4	18	16/30	0.016	0.41	0.052	1.32	0.429	10.90
C9334ZH	5	18	16/30	0.016	0.41	0.052	1.32	0.466	11.83
C9323ZH	6	18	16/30	0.016	0.41	0.052	1.32	0.505	12.83
C9324ZH	9	18	16/30	0.016	0.41	0.052	1.32	0.586	14.89
C9325ZH	12	18	16/30	0.016	0.41	0.062	1.57	0.656	16.67
C9335ZH	15	18	16/30	0.016	0.41	0.062	1.57	0.748	19.00

Product Construction:

Conductor:

- Fully annealed stranded tinned copper per ASTM B33

Insulation:

- Premium-grade, color-coded LSZH (Thermoplastic Polyolefin)
- Color per Chart C for 24 AWG and 22 AWG on page 97
- Color per Chart D for 20 AWG and larger on page 97

Shield:

- Unshielded

Jacket:

- Premium FR-LSZH (Thermoplastic Polyolefin)
- Operating temperature range: -40°C to +105°C

Applications:

- Advanced signal transmission in controlled environments
- Medical instrumentation and equipment
- Consumer electronic peripherals
- Industrial process control systems
- Suitable for EIA RS-232 applications

Features:

- Oil-resistant (OIL RES I)
- Sunlight-resistant (SUN RES)
- Nylon ripcord
- UV-resistant

Compliances:

- NEC Article 725 Type PLTC-ER (22 AWG and larger, UL: 105°C, 300 V)
- (-ER): approved for Exposed Run as defined per NEC Article 725
- NEC Article 725 Type CL2 (UL: 105°C, 150 V)
- NEC Article 800 Type CM/CMG (UL: 105°C, 300 V)
- RoHS Compliant Directive 2015/863/EU (RoHS-3)

Compliances: Flame & Smoke

- Vertical Tray Cable Flame Test per UL 1581 and IEEE 383 (70,000 BTU)
- CSA FT4/IEEE 1202 flame test per UL 1685
- IEC 60332-1, 3, Cat A: Flammability
- IEC 61034-1, 2 and Mil-DTL-24643B and NES 711: Smoke Index Emission
- IEC 60754-1, 2 and Mil-DTL-24643B: Halogen Content and Acid Gas Generation

Packaging:

- Please contact Customer Service for packaging and color options
- Data subject to change.



EXZEL® LSZH Multi-Paired, Foil Shielded

NEC Type CM, CMG, CL2 or PLTC-ER (UL)

Product Construction:

Conductor:

- Fully annealed stranded tinned copper per ASTM B33

Insulation:

- Premium-grade, color-coded LSZH (Thermoplastic Polyolefin)
- Color per Chart C for 24 AWG and 22 AWG on page 97
- Color per Chart D for 20 AWG and larger on page 97

Shield:

- 100% Flexfoil®, aluminum/polyester/aluminum, foil facing in
- Stranded tinned copper drain wire

Jacket:

- Premium FR-LSZH (Thermoplastic Polyolefin)
- Operating temperature range: -40°C to +105°C

Applications:

- Advanced signal transmission in controlled environments
- Medical instrumentation and equipment
- Consumer electronic peripherals
- Industrial process control systems
- Suitable for EIA RS-232 applications

Features:

- Oil-resistant (OIL RES I)
- Sunlight-resistant (SUN RES)
- Nylon ripcord
- UV-resistant

Compliances:

- NEC Article 725 Type PLTC-ER (22 AWG and larger, UL: 105°C, 300 V)
- (-ER): approved for Exposed Run as defined per NEC Article 725
- NEC Article 725 Type CL2 (UL: 105°C, 150 V)
- NEC Article 800 Type CM/CMG (UL: 105°C, 300 V)
- RoHS Compliant Directive 2015/863/EU (RoHS-3)

Compliances: Flame & Smoke

- Vertical Tray Cable Flame Test per UL 1581 and IEEE 383 (70,000 BTU)
- CSA FT4/IEEE 1202 flame test per UL 1685
- IEC 60332-1, 3, Cat A: Flammability
- IEC 61034-1, 2 and Mil-DTL-24643B and NES 711: Smoke Index Emission
- IEC 60754-1, 2 and Mil-DTL-24643B: Halogen Content and Acid Gas Generation

Packaging:

- Please contact Customer Service for packaging and color options
- Data subject to change.

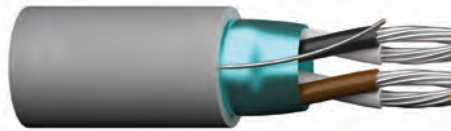

PART NUMBER	PAIRS	AWG SIZE	COND. STRAND	NOMINAL INSULATION THICKNESS		NOMINAL JACKET THICKNESS		NOMINAL CABLE DIAMETER	
				in	mm	in	mm	in	mm
C9400ZH	1	24	7/32	0.010	0.25	0.032	0.81	0.165	4.19
C9401ZH	2	24	7/32	0.010	0.25	0.032	0.81	0.225	5.71
C9402ZH	3	24	7/32	0.010	0.25	0.032	0.81	0.236	5.99
C9403ZH	4	24	7/32	0.010	0.25	0.032	0.81	0.256	6.50
C9404ZH	5	24	7/32	0.010	0.25	0.037	0.94	0.287	7.28
C9405ZH	6	24	7/32	0.010	0.25	0.037	0.94	0.309	7.84
C9406ZH	9	24	7/32	0.010	0.25	0.037	0.94	0.355	9.01
C9407ZH	11	24	7/32	0.010	0.25	0.047	1.19	0.403	10.23
C9408ZH	15	24	7/32	0.010	0.25	0.047	1.19	0.454	11.54
C9410ZH	1	22	7/30	0.013	0.33	0.037	0.94	0.187	4.75
C9411ZH	2	22	7/30	0.013	0.33	0.037	0.94	0.255	6.48
C9412ZH	3	22	7/30	0.013	0.33	0.037	0.94	0.268	6.80
C9413ZH	4	22	7/30	0.013	0.33	0.042	1.07	0.300	7.63
C9414ZH	5	22	7/30	0.013	0.33	0.042	1.07	0.324	8.22
C9415ZH	6	22	7/30	0.013	0.33	0.042	1.07	0.349	8.86
C9416ZH	9	22	7/30	0.013	0.33	0.052	1.32	0.421	10.70
C9417ZH	11	22	7/30	0.013	0.33	0.052	1.32	0.453	11.51
C9418ZH	15	22	7/30	0.013	0.33	0.052	1.32	0.512	13.00
C9450ZH	1	20	7/28	0.016	0.41	0.037	0.94	0.227	5.77
C9420ZH	2	20	7/28	0.016	0.41	0.042	1.07	0.332	8.44
C9421ZH	3	20	7/28	0.016	0.41	0.042	1.07	0.350	8.89
C9451ZH	4	20	7/28	0.016	0.41	0.042	1.07	0.382	9.69
C9452ZH	5	20	7/28	0.016	0.41	0.052	1.32	0.435	11.04
C9422ZH	6	20	7/28	0.016	0.41	0.052	1.32	0.470	11.93
C9423ZH	9	20	7/28	0.016	0.41	0.052	1.32	0.543	13.78
C9424ZH	12	20	7/28	0.016	0.41	0.052	1.32	0.587	14.92
C9453ZH	15	20	7/28	0.016	0.41	0.062	1.57	0.690	17.52
C9454ZH	1	18	16/30	0.016	0.41	0.037	0.94	0.243	6.17
C9455ZH	2	18	16/30	0.016	0.41	0.042	1.07	0.359	9.12
C9426ZH	3	18	16/30	0.016	0.41	0.042	1.07	0.379	9.62
C9456ZH	4	18	16/30	0.016	0.41	0.052	1.32	0.434	11.03
C9457ZH	5	18	16/30	0.016	0.41	0.052	1.32	0.471	11.96
C9427ZH	6	18	16/30	0.016	0.41	0.052	1.32	0.510	12.96
C9458ZH	9	18	16/30	0.016	0.41	0.052	1.32	0.591	15.02
C9459ZH	12	18	16/30	0.016	0.41	0.062	1.57	0.681	17.29
C9460ZH	15	18	16/30	0.016	0.41	0.062	1.57	0.753	19.12

EXZEL® LSZH Multi-Paired, Foil/Braid Shielded

NEC Type CM, CMG, CL2 or PLTC-ER (UL)



PART NUMBER	PAIRS	AWG SIZE	COND. STRAND	NOMINAL INSULATION THICKNESS		NOMINAL JACKET THICKNESS		NOMINAL CABLE DIAMETER	
				in	mm	in	mm	in	mm
C9500ZH	1	24	7/32	0.010	0.25	0.032	0.81	0.187	4.75
C9501ZH	2	24	7/32	0.010	0.25	0.032	0.81	0.247	6.27
C9502ZH	3	24	7/32	0.010	0.25	0.032	0.81	0.258	6.55
C9503ZH	4	24	7/32	0.010	0.25	0.037	0.94	0.288	7.31
C9504ZH	5	24	7/32	0.010	0.25	0.037	0.94	0.309	7.84
C9505ZH	6	24	7/32	0.010	0.25	0.037	0.94	0.331	8.40
C9506ZH	9	24	7/32	0.010	0.25	0.037	0.94	0.377	9.57
C9507ZH	11	24	7/32	0.010	0.25	0.047	1.19	0.425	10.79
C9508ZH	15	24	7/32	0.010	0.25	0.047	1.19	0.476	12.10
C9510ZH	1	22	7/30	0.013	0.33	0.037	0.94	0.209	5.31
C9511ZH	2	22	7/30	0.013	0.33	0.037	0.94	0.277	7.04
C9512ZH	3	22	7/30	0.013	0.33	0.042	1.07	0.300	7.61
C9513ZH	4	22	7/30	0.013	0.33	0.042	1.07	0.322	8.19
C9514ZH	5	22	7/30	0.013	0.33	0.042	1.07	0.346	8.78
C9515ZH	6	22	7/30	0.013	0.33	0.042	1.07	0.371	9.42
C9516ZH	9	22	7/30	0.013	0.33	0.052	1.32	0.443	11.25
C9517ZH	11	22	7/30	0.013	0.33	0.052	1.32	0.480	12.19
C9518ZH	15	22	7/30	0.013	0.33	0.052	1.32	0.539	13.69
C9529ZH	1	20	7/28	0.016	0.41	0.037	0.94	0.249	6.32
C9530ZH	2	20	7/28	0.016	0.41	0.042	1.07	0.354	9.00
C9521ZH	3	20	7/28	0.016	0.41	0.042	1.07	0.372	9.44
C9531ZH	4	20	7/28	0.016	0.41	0.052	1.32	0.424	10.76
C9532ZH	5	20	7/28	0.016	0.41	0.052	1.32	0.457	11.60
C9522ZH	6	20	7/28	0.016	0.41	0.052	1.32	0.497	12.62
C9523ZH	9	20	7/28	0.016	0.41	0.052	1.32	0.570	14.47
C9533ZH	12	20	7/28	0.016	0.41	0.062	1.57	0.652	16.56
C9534ZH	15	20	7/28	0.016	0.41	0.062	1.57	0.717	18.20
C9535ZH	1	18	16/30	0.016	0.41	0.037	0.94	0.265	6.73
C9525ZH	2	18	16/30	0.016	0.41	0.042	1.07	0.381	9.68
C9526ZH	3	18	16/30	0.016	0.41	0.052	1.32	0.421	10.69
C9536ZH	4	18	16/30	0.016	0.41	0.052	1.32	0.461	11.71
C9537ZH	5	18	16/30	0.016	0.41	0.052	1.32	0.498	12.64
C9527ZH	6	18	16/30	0.016	0.41	0.052	1.32	0.537	13.64
C9528ZH	9	18	16/30	0.016	0.41	0.062	1.57	0.638	16.21
C9538ZH	12	18	16/30	0.016	0.41	0.062	1.57	0.708	17.98
C9539ZH	15	18	16/30	0.016	0.41	0.062	1.57	0.780	19.81

Product Construction:

Conductor:

- Fully annealed stranded tinned copper per ASTM B33

Insulation:

- Premium-grade, color-coded LSZH (Thermoplastic Polyolefin)
- Color per Chart C for 24 AWG and 22 AWG on page 97
- Color per Chart D for 20 AWG and larger on page 97

Shield:

- Dual foil with overall braided shield
- Aluminum/polyester/aluminum foil with 100% coverage
- Stranded tinned copper drain wire
- Tinned copper braided shield, 85% min. coverage

Jacket:

- Premium FR-LSZH (Thermoplastic Polyolefin)
- Operating temperature range: -40°C to +105°C

Applications:

- Advanced signal transmission in controlled environments
- Medical instrumentation and equipment
- Consumer electronic peripherals
- Industrial process control systems
- Suitable for EIA RS-232 applications

Features:

- Oil-resistant (OIL RES I)
- Sunlight-resistant (SUN RES)
- Nylon ripcord
- UV-resistant

Compliances:

- NEC Article 725 Type PLTC-ER (22 AWG and larger, UL: 105°C, 300 V)
- (-ER): approved for Exposed Run as defined per NEC Article 725
- NEC Article 725 Type CL2 (UL: 105°C, 150 V)
- NEC Article 800 Type CM/CMG (UL: 105°C, 300 V)
- RoHS Compliant Directive 2015/863/EU (RoHS-3)

Compliances: Flame & Smoke

- Vertical Tray Cable Flame Test per UL 1581 and IEEE 383 (70,000 BTU)
- CSA FT4/IEEE 1202 flame test per UL 1685
- IEC 60332-1, 3, Cat A: Flammability
- IEC 61034-1, 2 and Mil-DTL-24643B and NES 711: Smoke Index Emission
- IEC 60754-1, 2 and Mil-DTL-24643B: Halogen Content and Acid Gas Generation

Packaging:

- Please contact Customer Service for packaging and color options
- Data subject to change.



Color Code Charts

MULTI-CONDUCTOR CABLES

NO. OF COND.	COLOR CHART A 24 AWG & 22 AWG	COLOR CHART B 20 AWG AND LARGER
	COLOR	COLOR
1	Black	Black
2	Brown	Red
3	Red	White
4	Orange	Green
5	Yellow	Orange
6	Green	Blue
7	Blue	Brown
8	Purple	Yellow
9	Slate	Purple
10	White	Slate
11	White/Black	Pink
12	White/Brown	Tan
13	White/Red	Red/Green
14	White/Orange	Red/Yellow
15	White/Yellow	Red/Black
16	White/Green	White/Black
17	White/Blue	White/Red
18	White/Purple	White/Green
19	White/Slate	White/Yellow
20	White/Black/Brown	White/Blue
21	White/Black/Red	White/Brown
22	White/Black/Orange	White/Orange
23	White/Black/Yellow	White/Slate
24	White/Black/Green	White/Purple
25	White/Black/Blue	White/Black/Red

MULTI-PAIR CABLES

NO. OF PAIRS	COLOR CHART C 24 AWG & 22 AWG	COLOR CHART D 20 AWG AND LARGER
	COLOR	COLOR
1	White-Black	Black-Red
2	White-Brown	Black-White
3	White-Red	Black-Green
4	White-Orange	Black-Blue
5	White-Yellow	Black-Brown
6	White-Green	Black-Yellow
7	White-Blue	Black-Orange
8	White-Purple	Red-Green
9	White-Slate	Red-White
10	Black-Brown	Red-Blue
11	Black-Red	Red-Yellow
12	Black-Orange	Red-Brown
13	Black-Yellow	Red-Orange
14	Black-Green	Green-Blue
15	Black-Blue	Green-White

IEC COLOR CHART

NO. OF COND.	COLOR
1	Brown
2	Blue
3	Green/Yellow

Fire Alarm Cables



Fire alarm systems have expanded from a rather simple and unsophisticated business configured upon large, electro-mechanical devices to one relying upon the most modern technologies of microprocessor and chip technology.

More and more end users— industrial, commercial as well as consumer—are relying upon these emerging systems to protect both property and life. These systems are only as good as their weakest component, whether that component be a processor or interconnecting wire and cable.

It is Prysmian’s charter that all products supplied for use in these and any other systems shall be constructed of only the finest available materials, and provide the service and assurance that the end user not only needs, but requires.

Aside from the quality materials used in these designs, specifiers and end users of CAROL® Brand wire and cable products have come to expect that these cables are registered and certified with the leading regulatory agencies such as Underwriters Laboratories ... and we haven’t let you down!

These designs have proven themselves in the area of fire system security over time; all are fabricated with solid, bare copper conductors and insulations and jackets of premium-grade PVC. Offered both with and without shields, the former to protect these critical circuits from noise, these cables will provide the latest in available technology for the system installer and contractor.

Prysmian CAROL Brand products are conveniently packaged in 1000’ or 500’ lengths to assist the installer.

Section	Page
Multi-Conductor, Unshielded, Non-Plenum	81
Multi-Conductor, Unshielded, Non-Plenum (CSA)	82
Multi-Conductor, Shielded, Non-Plenum	83
Multi-Conductor, Shielded, Non-Plenum (CSA)	84
Multi-Conductor, Unshielded, Plenum	85-86
Multi-Conductor, Shielded, Plenum	87-88
Multi-Conductor, Shielded, Riser	89
Multi-Conductor, Unshielded, Riser	90
Mid-Capacitance, Unshielded, Non-Plenum	91
Mid-Capacitance, Shielded, Non-Plenum	92
Mid-Capacitance, Unshielded, Plenum	93
Mid-Capacitance, Shielded, Plenum	94

Multi-Conductor, Unshielded, Non-Plenum

NEC Type FPLR and CL3R, NEC/CEC Type CMR

Product Construction:

Conductor:

- 22 thru 12 AWG fully annealed solid bare copper per ASTM B3

Insulation:

- Premium-grade, color-coded PVC
- Color code: See chart below

Jacket:

- Premium-grade PVC, red
- Suitable for use from -20°C to +105°C
- Round constructions have sequential footage markings to facilitate installation
- Includes ripcord on round constructions

Applications:

- Wiring of fire alarms
- Smoke detectors
- Voice communications
- Burglar alarms
- Fire protective circuits
- Suggested voltage rating: 300 volts

Complies:

- NEC Article 760 Type FPLR (UL: 105°C, 300 V)
- NEC Article 725 Type CL3R (UL: 105°C, 300 V)
- NEC Article 800 Type CMR (UL: 105°C, 300 V)
- Suitable for use in the State of California
- RoHS Compliant Directive 2015/863/EU (RoHS3)

Packaging:

- Please contact Customer Service for packaging and color options



CATALOG NUMBER	NO. OF COND.	AWG SIZE	COND. STRAND	NOM. INSULATION THICKNESS		NOMINAL O.D.	
				in	mm	in	mm
E2402S	2	18	Solid	0.032	0.81	0.105 x 0.210	2.67 x 5.33
E2404S	2	16	Solid	0.032	0.81	0.115 x 0.230	2.92 x 5.84
E2406S	2	14	Solid	0.032	0.81	0.126 x 0.260	3.20 x 6.60

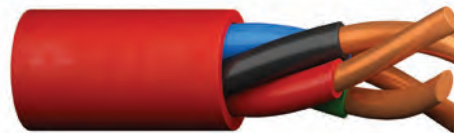

CATALOG NUMBER	NO. OF COND.	AWG SIZE	COND. STRAND	NOM. INSULATION THICKNESS		NOM. JACKET WALL		NOMINAL O.D.	
				in	mm	in	mm	in	mm
E1482S	2	22	Solid	0.010	0.25	0.015	0.38	0.121	3.07
E1484S	4	22	Solid	0.010	0.25	0.015	0.38	0.140	3.56
E1486S	6	22	Solid	0.010	0.25	0.015	0.38	0.168	4.27
E1502S	2	18	Solid	0.010	0.25	0.015	0.38	0.150	3.81
E1503S	3	18	Solid	0.010	0.25	0.015	0.38	0.160	4.06
E1504S	4	18	Solid	0.010	0.25	0.015	0.38	0.175	4.45
E1505S	5	18	Solid	0.010	0.25	0.015	0.38	0.193	4.90
E1506S	6	18	Solid	0.010	0.25	0.015	0.38	0.210	5.33
E1508S	8	18	Solid	0.010	0.25	0.015	0.38	0.230	5.84
E1512S	2	16	Solid	0.010	0.25	0.015	0.38	0.172	4.37
E1514S	4	16	Solid	0.010	0.25	0.015	0.38	0.202	5.13
E1522S*	2	14	Solid	0.013	0.33	0.015	0.38	0.210	5.33
E1524S*	4	14	Solid	0.013	0.33	0.015	0.38	0.248	6.30
E1532S*	2	12	Solid	0.013	0.33	0.015	0.38	0.244	6.20
E1534S*	4	12	Solid	0.013	0.33	0.015	0.38	0.288	7.32

COLOR CODE CHART

NO. OF COND.	COLOR
1	Black
2	Red
3	Brown
4	Blue
5	Orange
6	Yellow
7	Purple
8	Gray

* NEC FPLR/CL3R only.
Data subject to change.



Multi-Conductor, Unshielded, Non-Plenum

CSA FAS105, FPL (UL), NEC Type PLTC



Product Construction:

Conductor:

- 22 thru 12 AWG fully annealed solid bare copper per ASTM B3

Insulation:

- Premium-grade PVC
- Color code: See page 206 for the CSA Fire Alarm Color Code Chart

Jacket:

- Premium-grade PVC, red
- Temperature range: -20°C to +105°C
- TRU-Mark® print legend contains footage markings from 1000' to 0'

Applications:

- Wiring of fire alarms
- Smoke alarms
- Voice communications
- Burglar alarms
- Fire protective circuits
- Suggested voltage rating: 300 volts

Compliances:

- NEC Article 725 PLTC (UL: 105°C, 300 V)
- NEC Article 760 Type FPL (UL: 105°C, 300 V)
- CSA FAS105 (CSA: 105°C, 300 V)
- C22.2 No. 208-03 (R2008) Weather (Sunlight) Resistant (1,000 HR)
- RoHS Compliant Directive 2015/863/EU (RoHS-3)
- Passes CSA FT4 Vertical Flame Test

Packaging:

- Please contact Customer Service for packaging and color options

CATALOG NUMBER	NO. OF COND.	AWG SIZE	COND. STRAND	NOM. INSULATION THICKNESS		NOM. JACKET WALL		NOMINAL O.D.	
				in	mm	in	mm	in	mm
C4300A	6	22	Solid	0.012	0.30	0.042	1.07	0.232	5.89
C4301A	15	22	Solid	0.012	0.30	0.042	1.07	0.316	8.03
C4302A	20	22	Solid	0.012	0.30	0.042	1.07	0.346	8.79
C4304A	2	18	Solid	0.015	0.38	0.042	1.07	0.225	5.71
C4305A	3	18	Solid	0.015	0.38	0.042	1.07	0.236	5.99
C4306A	4	18	Solid	0.015	0.38	0.042	1.07	0.255	6.47
C4307A	5	18	Solid	0.015	0.38	0.042	1.07	0.274	6.96
C4308A	6	18	Solid	0.015	0.38	0.042	1.07	0.296	7.52
C4309A	7	18	Solid	0.015	0.38	0.042	1.07	0.296	7.52
C4310A	8	18	Solid	0.015	0.38	0.042	1.07	0.317	8.05
C4312A	9	18	Solid	0.015	0.38	0.042	1.07	0.339	8.61
C4313A	10	18	Solid	0.015	0.38	0.042	1.07	0.366	9.30
C4314A	11	18	Solid	0.015	0.38	0.042	1.07	0.366	9.30
C4315A	15	18	Solid	0.015	0.38	0.053	1.35	0.437	11.10
C4316A	20	18	Solid	0.015	0.38	0.053	1.35	0.480	12.19
C4317A	21	18	Solid	0.015	0.38	0.053	1.35	0.480	12.19
C4318A	30	18	Solid	0.015	0.38	0.053	1.35	0.558	14.17
C4321A	2	16	Solid	0.015	0.38	0.042	1.07	0.246	6.25
C4322A	3	16	Solid	0.015	0.38	0.042	1.07	0.258	6.55
C4323A	4	16	Solid	0.015	0.38	0.042	1.07	0.280	7.11
C4349A	5	16	Solid	0.015	0.38	0.042	1.07	0.302	7.67
C4324A	2	14	Solid	0.015	0.38	0.042	1.07	0.272	6.91
C4325A	3	14	Solid	0.015	0.38	0.042	1.07	0.286	7.26
C4326A	4	14	Solid	0.015	0.38	0.042	1.07	0.311	7.90
C4327A	2	12	Solid	0.020	0.51	0.042	1.07	0.326	8.28

Data subject to change.



Multi-Conductor, Shielded, Non-Plenum

NEC Type FPLR and CL3R, NEC/CEC Type CMR

Product Construction:

Conductor:

- 22 thru 12 AWG fully annealed solid bare copper per ASTM B3

Insulation:

- Premium-grade, color-coded PVC
- Color code: See chart below

Shield:

- Overall Flexfoil® polyester supported aluminum foil
- Stranded tinned copper drain wire

Jacket:

- Premium-grade PVC, red
- Temperature range: -20°C to +105°C
- Sequential footage markings to facilitate installation
- Includes ripcord

Applications:

- Wiring of fire alarms
- Smoke alarms
- Voice communications
- Burglar alarms
- Fire protective circuits
- Suggested voltage rating: 300 volts

Compliances:

- NEC Article 760 Type FPLR (UL: 105°C, 300 V)
- NEC Article 725 Type CL3R (UL: 105°C, 300 V)
- NEC Article 800 Type CMR (UL: 105°C, 300 V)
- Suitable for use in the State of California
- RoHS Compliant Directive 2015/863/EU (RoHS-3)

Packaging:

- Please contact Customer Service for packaging and color options



CATALOG NUMBER	NO. OF COND.	AWG SIZE	COND. STRAND	NOM. INSULATION THICKNESS		NOM. JACKET WALL		NOMINAL O.D.	
				in	mm	in	mm	in	mm
E2482S	2	22	Solid	0.010	0.25	0.015	0.38	0.126	3.20
E2484S	4	22	Solid	0.010	0.25	0.015	0.38	0.145	3.68
E2502S	2	18	Solid	0.010	0.25	0.015	0.38	0.158	4.01
E2503S	3	18	Solid	0.010	0.25	0.015	0.38	0.165	4.19
E2504S	4	18	Solid	0.010	0.25	0.015	0.38	0.183	4.65
E2506S	6	18	Solid	0.010	0.25	0.015	0.38	0.216	5.49
E2508S	8	18	Solid	0.010	0.25	0.015	0.38	0.235	5.97
E2522S	2	16	Solid	0.010	0.25	0.015	0.38	0.180	4.57
E2524S	4	16	Solid	0.010	0.25	0.015	0.38	0.210	5.33
E2532S*	2	14	Solid	0.013	0.33	0.015	0.38	0.218	5.54
E2534S*	4	14	Solid	0.013	0.33	0.015	0.38	0.253	6.43
E2542S*	2	12	Solid	0.013	0.33	0.015	0.38	0.252	6.40
E2544S*	4	12	Solid	0.013	0.33	0.015	0.38	0.293	7.44

* NEC FPLR/CL3R only.
Data subject to change.

COLOR CODE CHART

NO. OF COND.	COLOR
1	Black
2	Red
3	Brown
4	Blue
5	Orange
6	Yellow
7	Purple
8	Gray



Multi-Conductor, Shielded, Non-Plenum

CSA FAS105, FPL (UL), NEC Type PLTC



Product Construction:

Conductor:

- 18-12 AWG fully annealed, solid bare copper per ASTM B3

Insulation:

- Premium-grade, color-coded PVC
- Color code: See page 206 for the CSA Fire Alarm Color Code Chart

Shield:

- 100% Flexfoil® aluminum/polyester with 25% overlap, foil facing out
- Stranded tinned copper drain wire

Jacket:

- Premium-grade PVC, red
- Temperature range: -20°C to +105°C
- TRU-Mark® print legend contains footage markings from 1000' to 0'

Applications:

- Wiring of fire alarms
- Smoke alarms
- Voice communications
- Burglar alarms
- Fire protective circuits
- Suggested voltage rating: 300 volts

Compliances:

- NEC Article 725 PLTC (UL: 105°C, 300 V)
- NEC Article 760 Type FPL (UL: 105°C, 300 V)
- CSA FAS105 (CSA: 105°C, 300 V)
- C22.2 No. 208-03 (R2008) Weather (Sunlight) Resistant (1,000 HR)
- RoHS Compliant Directive 2015/863/EU (RoHS-3)
- Passes CSA FT4 Vertical Flame Test

Packaging:

- Please contact Customer Service for packaging and color options

CATALOG NUMBER	NO. OF COND.	AWG SIZE	COND. STRAND	DRAIN WIRE AWG	NOM. INSULATION THICKNESS		NOM. JACKET THICKNESS		NOMINAL O.D.	
					in	mm	in	mm	in	mm
C4334A	2	18	Solid	22	0.015	0.38	0.042	1.07	0.230	5.84
C4335A	3	18	Solid	22	0.015	0.38	0.042	1.07	0.241	6.12
C4336A	4	18	Solid	22	0.015	0.38	0.042	1.07	0.260	6.60
C4337A	5	18	Solid	22	0.015	0.38	0.042	1.07	0.279	7.09
C4338A	6	18	Solid	22	0.015	0.38	0.042	1.07	0.301	7.65
C4339A	7	18	Solid	22	0.015	0.38	0.042	1.07	0.301	7.65
C4340A	8	18	Solid	22	0.015	0.38	0.042	1.07	0.322	8.18
C4341A	9	18	Solid	22	0.015	0.38	0.042	1.07	0.344	8.74
C4342A	10	18	Solid	22	0.015	0.38	0.042	1.07	0.371	9.42
C4343A	30	18	Solid	22	0.015	0.38	0.053	1.35	0.563	14.30
C4344A	2	16	Solid	22	0.015	0.38	0.042	1.07	0.251	6.37
C4345A	3	16	Solid	22	0.015	0.38	0.042	1.07	0.263	6.68
C4346A	4	16	Solid	22	0.015	0.38	0.042	1.07	0.285	7.24
C4350A	5	16	Solid	22	0.015	0.38	0.042	1.07	0.307	7.80
C4347A	2	14	Solid	16	0.015	0.38	0.042	1.07	0.277	7.04
C4348A	2	12	Solid	16	0.020	0.51	0.042	1.07	0.331	8.41

Data subject to change.



Multi-Conductor, Unshielded, Plenum

NEC Type FPLP and CL3P, NEC/CEC Type CMP

Product Construction:

Conductor:

- 22 thru 12 AWG fully annealed solid bare copper per ASTM B3

Insulation:

- Premium-grade, color-coded Flexguard® PVC
- Color code: See chart below

Jacket:

- Premium-grade Flexguard® PVC, red
- Temperature range: 0°C to +75°C
- Sequential footage markings to facilitate installation
- Includes ripcord

Applications:

- Wiring of fire alarms
- Smoke detectors
- Voice communications
- Burglar alarms
- Fire protective circuits
- Suggested voltage rating: 300 volts

Compliances:

- NEC Article 760 Type FPLP (UL: 75°C, 300 V)
- NEC Article 725 Type CL3P (UL: 75°C, 300 V)
- NEC Article 800 Type CMP (UL: 75°C, 300 V)
- Suitable for use in the State of California
- RoHS Compliant Directive 2015/863/EU (RoHS-3)

Packaging:

- Please contact Customer Service for packaging and color options



CATALOG NUMBER	NO. OF COND.	AWG SIZE	COND. STRAND	NOM. INSULATION THICKNESS		NOM. JACKET WALL		NOMINAL O.D.	
				in	mm	in	mm	in	mm
E3482S	2	22	Solid	0.010	0.25	0.015	0.38	0.121	3.07
E3484S	4	22	Solid	0.010	0.25	0.015	0.38	0.137	3.47
E3502S	2	18	Solid	0.010	0.25	0.015	0.38	0.155	3.81
E3503S	3	18	Solid	0.010	0.25	0.015	0.38	0.160	4.06
E3504S	4	18	Solid	0.010	0.25	0.015	0.38	0.175	4.45
E3506S	6	18	Solid	0.010	0.25	0.015	0.38	0.211	5.36
E3512S	2	16	Solid	0.010	0.25	0.015	0.38	0.172	4.37
E3514S	4	16	Solid	0.010	0.25	0.015	0.38	0.202	5.13
E3522S*	2	14	Solid	0.012	0.30	0.015	0.38	0.205	5.21
E3524S*	4	14	Solid	0.012	0.30	0.015	0.38	0.243	6.17
E3532S*	2	12	Solid	0.012	0.30	0.015	0.38	0.244	6.20
E3534S*	4	12	Solid	0.012	0.30	0.015	0.38	0.284	7.21

* NEC FPLP/CL3P only.
Data subject to change.

COLOR CODE CHART

NO. OF COND.	COLOR
1	Black
2	Red
3	Brown
4	Blue
5	Orange
6	Yellow



Designed to Meet
NFPA 262 and CSA FT6
Steiner Tunnel Fire Tests
for Plenum Applications
Underwriters Laboratories Inc.



Multi-Conductor, Unshielded, Plenum

NEC/CEC Type CMP and/or NEC Type CL3P and FPLP

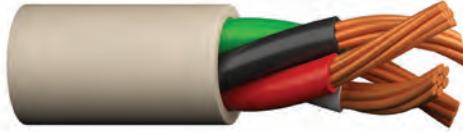

Product Construction:

Conductor:

- Stranded or solid bare copper per ASTM B3, B8 and B286

Insulation:

- Premium-grade, color-coded Flexguard® PVC
- Color code: See chart below

Jacket:

- Premium-grade Flexguard® PVC, natural
- Sequential footage markings to facilitate installation
- Temperature range: -20°C to +75°C

Applications:

- Power-limited control circuits
- Wiring of the following systems:
 - Intercom
 - Security
 - Audio
 - Background music
- Suggested voltage rating: 300 volts

Compliances:

- NEC Article 725 Type CL3P (UL: 75°C, 150 V)
- NEC Article 800 Type CMP (UL: 75°C, 300 V)
- NEC Article 760 Type FPLP (UL: 75°C, 300 V)
- Suitable for use in the State of California

Packaging:

- Please contact Customer Service for packaging and color options

CATALOG NUMBER	NO. OF COND.	AWG SIZE	COND. STRAND	NOM. INSULATION THICKNESS		NOM. JACKET WALL		NOMINAL O.D.	
				in	mm	in	mm	in	mm
E3000S	2	22	Solid	0.007	0.18	0.015	0.38	0.108	2.74
E3001S	4	22	Solid	0.007	0.18	0.015	0.38	0.124	3.15
E3002S	2	22	7/30	0.008	0.20	0.015	0.38	0.120	3.05
E3003S	3	22	7/30	0.008	0.20	0.015	0.38	0.127	3.23
E3004S	4	22	7/30	0.008	0.20	0.015	0.38	0.139	3.53
E3006S	6	22	7/30	0.008	0.20	0.015	0.38	0.164	4.17
E3008S	8	22	7/30	0.008	0.20	0.015	0.38	0.178	4.52
E3010S	10	22	7/30	0.008	0.20	0.015	0.38	0.194	4.92
E3012S	12	22	7/30	0.008	0.20	0.015	0.38	0.211	5.36
E3022S	2	20	7/28	0.009	0.23	0.015	0.20	0.134	3.40
E3023S	3	20	7/28	0.009	0.23	0.015	0.20	0.142	3.61
E3024S	4	20	7/28	0.009	0.23	0.015	0.20	0.156	3.96
E3030S	2	18	Solid	0.008	0.20	0.015	0.38	0.142	3.61
E3032S	2	18	7/26	0.008	0.20	0.015	0.38	0.156	3.96
E3033S	3	18	7/26	0.008	0.20	0.015	0.38	0.166	4.22
E3034S	4	18	7/26	0.008	0.20	0.015	0.38	0.187	4.75
E3036S	6	18	7/26	0.008	0.20	0.015	0.38	0.216	5.49
E3038S	8	18	7/26	0.008	0.20	0.015	0.38	0.235	5.97
E3042S	2	16	19/0117	0.008	0.20	0.015	0.38	0.174	4.42
E3043S	3	16	19/0117	0.008	0.20	0.015	0.38	0.185	4.70
E3044S	4	16	19/0117	0.009	0.23	0.008	0.20	0.205	5.21
E3052S*	2	14	19/0147	0.011	0.28	0.015	0.38	0.216	5.49
E3054S*	4	14	19/0147	0.011	0.28	0.015	0.38	0.255	6.48
E3062S*	2	12	19/0185	0.011	0.28	0.015	0.38	0.252	6.40
E3064S*	4	12	19/0185	0.011	0.28	0.015	0.38	0.298	7.57

* NEC CL3P/FPLP only
Data subject to change.

COLOR CODE CHART

NO. OF COND.	COLOR	NO. OF COND.	COLOR	NO. OF COND.	COLOR	NO. OF COND.	COLOR
1	Black	4	Green	7	Orange	10	Gray
2	Red	5	Brown	8	Yellow	11	Pink
3	White	6	Blue	9	Purple	12	Tan



Multi-Conductor, Shielded, Plenum

NEC/CEC Type CMP and/or NEC Type CL3P and FPLP

Product Construction:

Conductor:

- Stranded or solid bare copper per ASTM B3, B8 and B286

Insulation:

- Premium-grade, color-coded Flexguard® PVC

Shield:

- Overall Flexfoil® polyester supported aluminum foil
- Stranded tinned copper drain wire

Jacket:

- Premium-grade Flexguard® PVC, natural
- Sequential footage markings to facilitate installation
- Temperature range: -20°C to +75°C

Applications:

- Power-limited control circuits
- Wiring of the following systems:
 - Intercom
 - Security
 - Audio
 - Background music
- Suggested voltage rating: 300 volts

Compliances:

- NEC Article 725 Type CL3P (UL: 75°C, 150 V)
- NEC Article 800 Type CMP (UL: 75°C, 300 V)
- NEC Article 760 Type FPLP (UL: 75°C, 300 V)
- Suitable for use in the State of California

Packaging:

- Please contact Customer Service for packaging and color options



CATALOG NUMBER	NO. OF COND.	AWG SIZE	COND. STRAND	NOM. INSULATION THICKNESS		NOM. JACKET WALL		NOMINAL O.D.	
				in	mm	in	mm	in	mm
E2100S	2	22	Solid	0.007	0.18	0.015	0.38	0.116	2.95
E2102S	2	22	7/30	0.008	0.20	0.015	0.38	0.128	3.25
E2103S	3	22	7/30	0.008	0.20	0.015	0.38	0.131	3.33
E2104S	4	22	7/30	0.008	0.20	0.015	0.38	0.147	3.73
E2106S	6	22	7/30	0.008	0.20	0.015	0.38	0.176	4.47
E2108S	8	22	7/30	0.008	0.20	0.015	0.38	0.184	4.67
E2110S	10	22	7/30	0.008	0.20	0.015	0.38	0.215	5.46
E2112S	12	22	7/30	0.008	0.20	0.015	0.38	0.222	5.64
E2122S	2	20	7/28	0.009	0.23	0.015	0.20	0.139	3.53
E2123S	3	20	7/28	0.009	0.23	0.015	0.20	0.147	3.73
E2124S	4	20	7/28	0.009	0.23	0.015	0.20	0.161	4.09
E2200S	2	18	Solid	0.008	0.20	0.015	0.38	0.148	3.76
E2202S	2	18	7/26	0.008	0.20	0.015	0.38	0.164	4.17
E2203S	3	18	7/26	0.008	0.20	0.015	0.38	0.169	4.29
E2204S	4	18	7/26	0.008	0.20	0.015	0.38	0.185	4.70
E2206S	6	18	7/26	0.010	0.25	0.008	0.20	0.218	5.54
E2208S	8	18	7/26	0.010	0.25	0.008	0.20	0.237	6.02
E2242S	2	16	19/0117	0.008	0.20	0.015	0.38	0.179	4.55
E2243S	3	16	19/0117	0.008	0.20	0.015	0.38	0.190	4.83
E2244S	4	16	19/0117	0.008	0.20	0.015	0.38	0.209	5.31
E2252S*	2	14	19/0147	0.008	0.20	0.011	0.28	0.235	5.97
E2254S*	4	14	19/0147	0.008	0.20	0.011	0.28	0.260	6.60
E2262S*	2	12	19/0185	0.008	0.20	0.011	0.28	0.257	6.53
E2264S*	4	12	19/0185	0.008	0.20	0.011	0.28	0.303	7.70

* NEC CL3P/FPLP only
Data subject to change.

COLOR CODE CHART

NO. OF COND.	COLOR	NO. OF COND.	COLOR	NO. OF COND.	COLOR	NO. OF COND.	COLOR
1	Black	4	Green	7	Orange	10	Gray
2	Red	5	Brown	8	Yellow	11	Pink
3	White	6	Blue	9	Purple	12	Tan



Multi-Conductor, Shielded, Plenum

NEC Type FPLP



CATALOG NUMBER	NO. OF COND.	AWG SIZE	COND. STRAND	NOM. INSULATION THICKNESS		NOM. JACKET WALL		NOMINAL O.D.	
				in	mm	in	mm	in	mm
E3542S	2	22	Solid	0.010	0.25	0.015	0.38	0.126	3.20
E3602S	2	18	Solid	0.010	0.25	0.015	0.38	0.158	4.01
E3603S	3	18	Solid	0.010	0.25	0.015	0.38	0.165	4.19
E3604S	4	18	Solid	0.010	0.25	0.015	0.38	0.183	4.65
E3606S	6	18	Solid	0.010	0.25	0.015	0.38	0.216	5.49
E3612S	2	16	Solid	0.010	0.25	0.015	0.38	0.180	4.57
E3614S	4	16	Solid	0.010	0.25	0.015	0.38	0.210	5.33
E3622S	2	14	Solid	0.012	0.30	0.015	0.38	0.210	5.33
E3624S	4	14	Solid	0.012	0.30	0.015	0.38	0.248	6.30
E3632S	2	12	Solid	0.012	0.30	0.015	0.38	0.252	6.40
E3634S	4	12	Solid	0.012	0.30	0.015	0.38	0.300	7.62

Data subject to change.

Product Construction:

Conductor:

- 22 thru 12 AWG fully annealed solid bare copper per ASTM B3

Insulation:

- Premium-grade, color-coded Flexguard® PVC
- Color code: See chart below

Shield:

- Overall Flexfoil® polyester supported aluminum foil
- Stranded tinned copper drain wire

Jacket:

- Premium-grade Flexguard® PVC, red
- Suitable for use from 0°C to +75°C
- Sequential footage markings to facilitate installation
- Includes ripcord

Applications:

- Wiring of fire alarms
- Smoke detectors
- Voice communications
- Burglar alarms
- Fire protective circuits
- Suggested voltage rating: 300 volts

Compliances:

- NEC Article 760 Type FPLP (UL: 75°C, 300 V)
- NEC Article 725 Type CL3P (UL: 75°C, 300 V)
- NEC Article 800 Type CMP (UL: 75°C, 300 V)
- Suitable for use in the State of California
- Designed to meet NFPA 262 and CSA FT6 Steiner Tunnel Fire Tests for Plenum Applications

Packaging:

- Please contact Customer Service for packaging and color options

COLOR CODE CHART

NO. OF COND.	COLOR
1	Black
2	Red
3	Brown
4	Blue
5	Orange
6	Yellow



Designed to Meet
NFPA 262 and CSA FT6
Steiner Tunnel Fire Tests
for Plenum Applications

Underwriters Laboratories Inc.



Multi-Conductor, Unshielded, Riser

NEC/CEC Type CMR and/or NEC Type CL3R and FPLR

Product Construction:

Conductor:

- Stranded or solid bare copper per ASTM B3, B8 and B286

Insulation:

- Premium-grade, color-coded PVC
- Color code: See chart below

Jacket:

- Premium-grade PVC, gray
- Sequential footcage markings to facilitate installation
- Temperature range: -20°C to +105°C
- Includes ripcord

Applications:

- Power-limited control circuits
- Wiring of the following systems:
 - Intercom
 - Security
 - Audio
 - Background music
- Suggested voltage rating: 300 volts

Compliances:

- NEC Article 725 Type CL3R (UL: 105°C, 150 V)
- NEC Article 800 Type CMR (UL: 105°C, 300 V)
- NEC Article 760 Type FPLR (UL: 105°C, 300 V)
- RoHS Compliant Directive 2015/863/EU (RoHS-3)
- Suitable for use in the State of California

Packaging:

- Please contact Customer Service for packaging and color options



CATALOG NUMBER	NO. OF COND.	AWG SIZE	COND. STRAND	NOM. INSULATION THICKNESS		NOM. JACKET WALL		NOMINAL O.D.	
				in	mm	in	mm	in	mm
E1000S	2	22	Solid	0.007	0.20	0.015	0.38	0.118	3.00
E1001S	4	22	Solid	0.007	0.20	0.015	0.38	0.126	3.20
E1002S	2	22	7/30	0.008	0.20	0.015	0.38	0.122	3.10
E1003S	3	22	7/30	0.008	0.20	0.015	0.38	0.130	3.58
E1004S	4	22	7/30	0.008	0.20	0.015	0.38	0.141	3.66
E1006S	6	22	7/30	0.008	0.20	0.015	0.38	0.164	4.17
E1008S	8	22	7/30	0.008	0.20	0.015	0.38	0.180	4.57
E1010S	10	22	7/30	0.008	0.20	0.015	0.38	0.212	5.38
E1012S	12	22	7/30	0.008	0.20	0.015	0.38	0.219	5.56
E1022S	2	20	7/28	0.007	0.18	0.008	0.20	0.134	3.40
E1023S	3	20	7/28	0.008	0.20	0.015	0.38	0.142	3.61
E1024S	4	20	7/28	0.008	0.20	0.015	0.38	0.156	3.96
E1030S	2	18	Solid	0.008	0.20	0.015	0.38	0.144	3.66
E1032S	2	18	7/26	0.008	0.20	0.015	0.38	0.154	3.91
E1033S	3	18	7/26	0.008	0.20	0.015	0.38	0.163	4.14
E1034S	4	18	7/26	0.008	0.20	0.015	0.38	0.180	4.57
E1036S	6	18	7/26	0.008	0.20	0.015	0.38	0.216	5.49
E1038S	8	18	7/26	0.008	0.20	0.015	0.38	0.245	6.22
E1040S	10	18	7/26	0.008	0.20	0.015	0.38	0.282	7.16
E1041S	12	18	7/26	0.009	0.23	0.015	0.38	0.291	7.39
E1042S	2	16	19/0117	0.009	0.25	0.015	0.38	0.178	4.52
E1043S	3	16	19/0117	0.009	0.25	0.015	0.38	0.193	4.90
E1044S	4	16	19/0117	0.009	0.25	0.015	0.38	0.210	5.33
E1052S*	2	14	19/0147	0.013	0.33	0.015	0.38	0.224	5.69
E1054S*	4	14	19/0147	0.013	0.33	0.015	0.38	0.264	6.71
E1062S*	2	12	19/0185	0.013	0.33	0.015	0.38	0.260	6.60
E1064S*	4	12	19/0185	0.013	0.33	0.015	0.38	0.312	7.92

* NEC CL3R/FPLR only
Data subject to change.

COLOR CODE CHART

NO. OF COND.	COLOR	NO. OF COND.	COLOR	NO. OF COND.	COLOR	NO. OF COND.	COLOR
1	Black	4	Green	7	Orange	10	Gray
2	Red	5	Brown	8	Yellow	11	Pink
3	White	6	Blue	9	Purple	12	Tan



Multi-Conductor, Shielded, Riser

NEC/CEC Type CMR and/or NEC Type CL3R and FPLR



Product Construction:

Conductor:

- Stranded or solid bare copper per ASTM B3, B8 and B286

Insulation:

- Premium-grade, color-coded PVC
- Color code: See chart below

Shield:

- Overall Flexfoil® polyester supported aluminum foil
- Stranded tinned copper drain wire

Jacket:

- Premium-grade PVC, gray
- Sequential footage markings to facilitate installation
- Temperature range: -20°C to +105°C
- Includes ripcord

Applications:

- Power-limited control circuits
- Wiring of the following systems:
 - Intercom
 - Security
 - Audio
 - Background music
- Suggested voltage rating: 300 volts

Compliances:

- NEC Article 725 Type CL3R (UL: 105°C, 300 V)
- NEC Article 800 Type CMR (UL: 105°C, 300 V)
- NEC Article 760 Type FPLR (UL: 105°C, 300 V)
- RoHS Compliant Directive 2015/863/EU (RoHS-3)
- Suitable for use in the State of California

Packaging:

- Please contact Customer Service for packaging and color options

CATALOG NUMBER	NO. OF COND.	AWG SIZE	COND. STRAND	NOM. INSULATION THICKNESS		NOM. JACKET WALL		NOMINAL O.D.	
				in	mm	in	mm	in	mm
E2000S	2	22	Solid	0.008	0.20	0.015	0.38	0.117	2.97
E2002S	2	22	7/30	0.008	0.20	0.015	0.38	0.132	3.35
E2003S	3	22	7/30	0.008	0.20	0.015	0.38	0.135	3.43
E2004S	4	22	7/30	0.008	0.20	0.015	0.38	0.147	3.73
E2006S	6	22	7/30	0.008	0.20	0.015	0.38	0.173	4.39
E2008S	8	22	7/30	0.008	0.20	0.015	0.38	0.195	4.95
E2010S	10	22	7/30	0.008	0.20	0.015	0.38	0.218	5.54
E2012S	12	22	7/30	0.010	0.25	0.008	0.20	0.222	5.64
E2022S	2	20	7/28	0.007	0.18	0.008	0.20	0.142	3.61
E2023S	3	20	7/28	0.007	0.18	0.008	0.20	0.151	3.84
E2024S	4	20	7/28	0.007	0.18	0.008	0.20	0.161	4.09
E2030S	2	18	Solid	0.009	0.20	0.008	0.20	0.147	3.73
E2032S	2	18	7/26	0.008	0.20	0.015	0.38	0.159	4.04
E2033S	3	18	7/26	0.008	0.20	0.015	0.38	0.168	4.27
E2034S	4	18	7/26	0.008	0.20	0.015	0.38	0.184	4.67
E2036S	6	18	7/26	0.008	0.20	0.015	0.38	0.221	5.61
E2038S	8	18	7/26	0.008	0.20	0.015	0.38	0.240	6.10
E2040S	10	18	7/26	0.008	0.20	0.015	0.38	0.287	7.29
E2041S	12	18	7/26	0.008	0.20	0.015	0.38	0.296	7.52
E2042S	2	16	19/0117	0.009	0.23	0.015	0.38	0.189	4.80
E2043S	3	16	19/0117	0.009	0.23	0.015	0.38	0.198	5.03
E2044S	4	16	19/0117	0.009	0.23	0.015	0.38	0.219	5.56
E2052S*	2	14	19/0147	0.013	0.33	0.015	0.38	0.245	6.22
E2054S*	4	14	19/0147	0.013	0.33	0.015	0.38	0.269	6.83
E2062S*	2	12	19/0185	0.013	0.33	0.015	0.38	0.281	7.14
E2064S*	4	12	19/0185	0.013	0.33	0.015	0.38	0.312	7.92

* NEC CL3R/FPLR only
Data subject to change.

COLOR CODE CHART 5

NO. OF COND.	COLOR	NO. OF COND.	COLOR	NO. OF COND.	COLOR	NO. OF COND.	COLOR
1	Black	4	Green	7	Orange	10	Gray
2	Red	5	Brown	8	Yellow	11	Pink
3	White	6	Blue	9	Purple	12	Tan



Mid-Capacitance, Unshielded, Non-Plenum

NEC Type FPL for Microprocessor-Controlled Systems

Product Construction:

Conductor:

- 18 thru 12 AWG fully annealed solid bare copper per ASTM B3

Insulation:

- Premium-grade, color-coded polypropylene
- Color code: See chart below

Jacket:

- PVC, red
- Temperature range: -20°C to +75°C



Applications:

- Addressable fire alarm systems
- Fire alarm systems
- Voice communications
- Smoke detectors
- Pull boxes
- Suggested voltage rating: 300 volts

Compliances:

- NEC Article 760 Type FPL
- Suitable for use in the State of California
- RoHS Compliant Directive 2015/863/EU (RoHS-3)

Packaging:

- Please contact Customer Service for packaging and color options

CATALOG NUMBER	NO. OF COND	AWG SIZE	COND. STRAND	NOM. INSULATION THICKNESS		NOM. JACKET THICKNESS		NOMINAL O.D.		NOM.* C-C CAP. pF/ft
				in	mm	in	mm	in	mm	
C0471	2	18	Solid	0.014	0.36	0.020	0.51	0.177	4.50	16.5
C0485	4	18	Solid	0.014	0.36	0.020	0.51	0.205	5.21	16.5
C0473	2	16	Solid	0.016	0.41	0.020	0.51	0.206	5.23	17.5
C0486	4	16	Solid	0.016	0.41	0.020	0.51	0.240	6.10	17.5
C0491	2	14	Solid	0.018	0.46	0.020	0.51	0.240	6.10	18.0
C0492	2	12	Solid	0.020	0.51	0.020	0.51	0.282	7.16	19.0

*Capacitance between conductors
Data subject to change.

COLOR CODE CHART

NO. OF COND.	COLOR
1	Black
2	Red
3	Brown
4	Blue



Mid-Capacitance, Shielded, Non-Plenum

NEC Type FPL for Microprocessor-Controlled Systems



Product Construction:

Conductor:

- 18 thru 12 AWG fully annealed solid bare copper per ASTM B3

Insulation:

- Premium-grade, color-coded polypropylene
- Color code: See chart below

Shield:

- 100% Flexfoil® aluminum/polyester, 25% overlap, minimum
- Stranded tinned copper drain wire

Jacket:

- PVC, red
- Temperature range: -20°C to +75°C

Applications:

- Addressable fire alarm systems
- Fire alarm systems
- Voice communications
- Smoke detectors
- Pull boxes
- Suggested voltage rating: 300 volts

Compliances:

- NEC Article 760 Type FPL
- Suitable for use in the State of California
- RoHS Compliant Directive 2015/863/EU (RoHS-3)

Packaging:

- Please contact Customer Service for packaging and color options

CATALOG NUMBER	NO. OF COND.	AWG SIZE	COND. STRAND	NOM. INSULATION THICKNESS		NOM. JACKET THICKNESS		NOMINAL O.D.		NOMINAL CAP. * pF/ft	
				in	mm	in	mm	in	mm	A	B
C0472	2	18	Solid	0.014	0.36	0.020	0.51	0.182	4.88	27.0	49.0
C0494	4	18	Solid	0.014	0.36	0.020	0.51	0.210	5.33	24.5	44.0
C0474	2	16	Solid	0.016	0.41	0.020	0.51	0.214	5.44	29.0	52.0
C0495	4	16	Solid	0.016	0.41	0.020	0.51	0.246	6.25	26.0	46.5
C0475	2	14	Solid	0.018	0.46	0.020	0.51	0.245	6.22	31.0	55.5
C0496	4	14	Solid	0.018	0.46	0.020	0.51	0.287	7.29	27.5	49.5
C0476	2	12	Solid	0.020	0.51	0.020	0.51	0.287	7.29	33.0	60.0
C0497	4	12	Solid	0.020	0.51	0.020	0.51	0.337	8.56	29.0	52.5

*A - Capacitance between conductors

*B - Capacitance between one conductor and other conductors connected to shield

Data subject to change.

COLOR CODE CHART

NO. OF COND.	COLOR
1	Black
2	Red
3	Brown
4	Blue



Mid-Capacitance, Unshielded, Plenum

NEC Type FPLP for Microprocessor-Controlled Systems

Product Construction:

Conductor:

- 18 thru 12 AWG fully annealed solid bare copper per ASTM B3

Insulation:

- Premium-grade, color-coded fluoropolymer
- Color code: See chart below

Jacket:

- Premium-grade Flexguard® PVC, red
- Temperature range: -20°C to +75°C
- Includes ripcord



Applications:

- Addressable fire alarm systems
- Fire alarm systems
- Voice communications
- Smoke detectors
- Pull boxes
- Suggested voltage rating: 300 volts

Compliances:

- NEC Article 760 Type FPLP (UL: 75°C, 300 V)
- Suitable for use in the State of California

Packaging:

- Please contact Customer Service for packaging and color options

CATALOG NUMBER	NO. OF COND	AWG SIZE	COND. STRAND	NOM. INSULATION THICKNESS		NOM. JACKET THICKNESS		NOMINAL O.D.		NOM.* C-C CAP. pF/ft
				in	mm	in	mm	in	mm	
C3240	2	18	Solid	0.014	0.36	0.015	0.38	0.172	4.37	19.0
C3242	4	18	Solid	0.014	0.36	0.015	0.38	0.195	4.95	19.0
C3241	2	16	Solid	0.016	0.41	0.015	0.38	0.196	4.98	20.0
C3243	4	16	Solid	0.016	0.41	0.015	0.38	0.231	5.87	20.0
C3244	2	14	Solid	0.018	0.46	0.020	0.51	0.242	6.15	20.0
C3245	4	14	Solid	0.018	0.46	0.020	0.51	0.286	7.26	20.0
C3246	2	12	Solid	0.020	0.51	0.020	0.51	0.282	7.16	22.0
C3247	4	12	Solid	0.020	0.51	0.020	0.51	0.333	8.45	22.0

*Capacitance between conductors
Data subject to change.

COLOR CODE CHART

NO. OF COND.	COLOR
1	Black
2	Red
3	Brown
4	Blue



Designed to Meet
NFPA 262 and CSA FT6
Steiner Tunnel Fire Tests
for Plenum Applications
Underwriters Laboratories Inc.



Mid-Capacitance, Shielded, Plenum

NEC Type FPLP for Microprocessor-Controlled Systems



CATALOG NUMBER	NO. OF COND.	AWG SIZE	COND. STRAND	NOM. INSULATION THICKNESS		NOM. JACKET THICKNESS		NOMINAL O.D.		NOMINAL CAP. * pF/ft	
				in	mm	in	mm	in	mm	A	B
C3167	2	18	Solid	0.014	0.36	0.015	0.38	0.172	4.37	31.0	56.0
C3170	4	18	Solid	0.014	0.36	0.015	0.38	0.202	5.13	28.0	50.0
C3169	2	16	Solid	0.016	0.41	0.015	0.38	0.203	5.16	33.0	59.0
C3171	4	16	Solid	0.016	0.41	0.015	0.38	0.238	6.05	29.0	53.0
C3172	2	14	Solid	0.018	0.46	0.020	0.51	0.247	6.27	35.0	63.0
C3173	4	14	Solid	0.018	0.46	0.020	0.51	0.289	7.34	30.0	56.0
C3174	2	12	Solid	0.020	0.51	0.020	0.51	0.289	7.34	38.0	68.0
C3175	4	12	Solid	0.020	0.51	0.020	0.51	0.340	8.64	33.0	60.0

*A - Capacitance between conductors

*B - Capacitance between one conductor and other conductors connected to shield
Data subject to change.

COLOR CODE CHART

NO. OF COND.	COLOR
1	Black
2	Red
3	Brown
4	Blue

Product Construction

Conductor:

- 18 thru 12 AWG fully annealed solid bare copper per ASTM B3

Insulation:

- Premium-grade, color-coded fluoropolymer
- Color code: See chart below

Shield:

- 100% Flexfoil® aluminum/polyester foil, 25% overlap, minimum
- Stranded tinned copper drain wire

Jacket:

- Premium-grade Flexguard® PVC, red
- Temperature range: -20°C to +75°C
- Includes ripcord

Applications:

- Addressable fire alarm systems
- Fire alarm systems
- Voice communications
- Smoke detectors
- Pull boxes
- Suggested voltage rating: 300 volts

Compliances:

- NEC Article 760 Type FPLP (UL: 75°C, 300 V)
- Suitable for use in the State of California

Packaging:

- Please contact Customer Service for packaging and color options



Designed to Meet
NFPA 262 and CSA FT6
Steiner Tunnel Fire Tests
for Plenum Applications
Underwriters Laboratories Inc.



Sound, Alarm & Security Cable

6

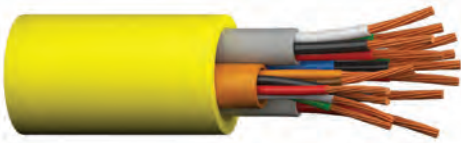

The sound and security industry in the United States has grown from a simple and unsophisticated business, begun some 45 years ago, to one which has developed technology to the degree that specialized wires and cables are now much in demand.

No longer are the security and sound industries characterized by large electromechanical relays and large contactors; today these circuits incorporate the latest in microprocessors and solid state devices to not only improve functionality but also to guarantee performance.

As a major wire producer, our role is to ensure that the wires and cables that go into these systems are as reliable as the other components...the net result is a fully integrated system which will provide peace of mind to the system user.

Also in this section are Prysmian's CAROL® Brand wire and cable designs suitable for a variety of applications, both in industrial and commercial environments, including telephone systems, intercoms, burglar alarms, business machines and thermostats.

Aside from the quality materials used in these designs, specifiers and users of CAROL Brand wire and cable products have come to expect that these cables are registered and certified with the leading regulatory agencies such as Underwriters Laboratories... and we haven't let you down!

CAROL Brand designs have proven themselves in the area of sound and security over time; most are fabricated with solid or stranded, bare copper conductors with insulations and jackets of premium grades of PVC. We offer both parallel and cabled designs both with and without shields. Sequential footage markings on the jackets are offered on all products.

Prysmian's CAROL Brand products are conveniently packaged in 1000' or 500' lengths to assist the installer.

Section	Page
Composite Access Control Cable, Plenum	96
Composite Access Control Cable, Riser	97
Multi-Conductor, Unshielded, Riser	98
Multi-Conductor, Shielded, Riser	99
Multi-Conductor, Unshielded, Plenum	100
Multi-Conductor, Shielded, Plenum	101
Telephone Station/Intercom & Speaker/Burglar Alarm	102
Thermostat Wire Type LVT	103
Thermostat Wire Type CL2	104
Thermostat Wire, Unjacketed	105



Composite Access Control Cable, Plenum

NEC Type CMP, (UL), c(UL)

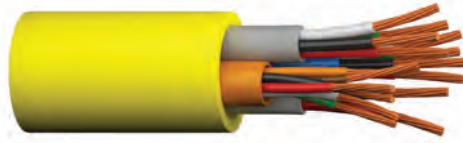

Product Construction:

Conductor:

- Stranded bare copper

Jacket:

- Flexguard® PVC
- Temperature range: 0°C to +60°C
- Individual elements marked for application (see diagram below)
- Yellow overall jacket

Shields:

- Choice between all 4 elements shielded or just the 3-pair element shielded

Applications:

- Security systems
- Access control
- Card reader
- Door control
- REX
- Power-limited controls

Compliances:

- NEC Article 800 Type CMP (UL), c(UL)
- RoHS Compliant Directive 2015/863/EU (RoHS-3)

Packaging:

- 500' and 1000' reels

CATALOG NUMBER	OVERALL NOMINAL O.D. INCH (MM)	COMPONENT NO.	COMPONENT DESCRIPTIONS	CONDUCTORS COLOR CODE	COMPONENT NOMINAL O.D. INCH (MM)	INSULATION THICKNESS INCH (MM)
4EPL4S	0.430	1	4 Cond, 18 AWG, Shielded	White, Black, Red, Green	0.180 (4.572)	0.008 (0.2032)
		2	3 Pair, 22 AWG, Shielded	White & Green, Orange & Brown, Red & Black	0.195 (4.93)	0.008 (0.2032)
		3	2 Cond, 22 AWG, Shielded	Red, Black	0.125 (3.175)	0.008 (0.2032)
		4	4 Cond, 22 AWG, Shielded	White, Black, Red, Green	0.145 (3.683)	0.008 (0.2032)
4EPLIS	0.420	1	4 Cond, 18 AWG, Unshielded	White, Black, Red, Green	0.180 (4.572)	0.008 (0.2032)
		2	3 Pair, 22 AWG, Shielded	White & Green, Orange & Brown, Red & Black	0.195 (4.93)	0.008 (0.2032)
		3	2 Cond, 22 AWG, Unshielded	Red, Black	0.125 (3.175)	0.008 (0.2032)
		4	4 Cond, 22 AWG, Unshielded	White, Black, Red, Green	0.145 (3.683)	0.008 (0.2032)

Data subject to change.

JACKET COLOR CODING & COMPONENT APPLICATION

Jacket Color	Component	Cable Type	Application
Gray	1	4 Conductor, 18 AWG	Lock Power
Orange	2	3 Pair, 22 AWG	Card Reader
White	3	2 Conductor, 22 AWG	Door Contact
Blue	4	4 Conductor, 22 AWG	Rex/Spare

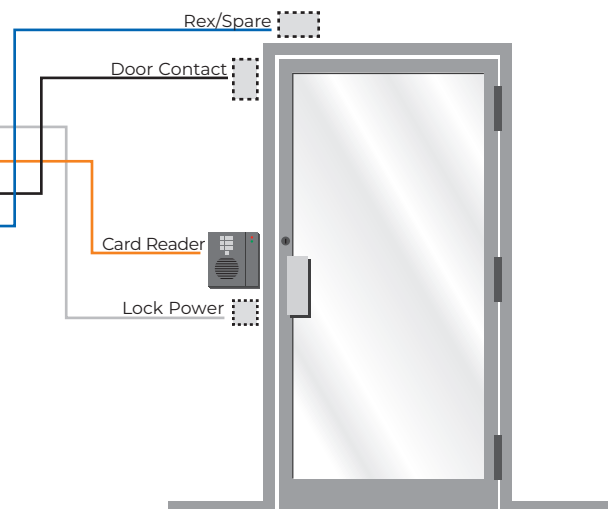

Composite Access Control Cable, Riser

NEC Type CMR, (UL), c(UL)

Product Construction:

Conductor:

- Stranded bare copper

Jacket:

- PVC
- Temperature range: -20°C to +60°C
- Individual elements marked for application (see diagram below)
- Blue overall jacket

Shields:

- Choice between all 4 elements shielded or just the 3-pair shielded

Applications:

- Security systems
- Access control
- Card reader
- Door control
- REX
- Power-limited controls

Compliances:

- NEC Article 800 Type CMR (UL), c(UL)
- RoHS Compliant Directive 2015/863/EU (RoHS-3)

Packaging:

- 500' and 1000' reels

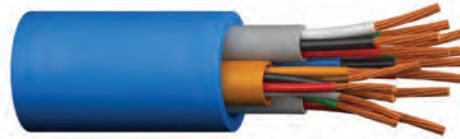

CATALOG NUMBER	OVERALL NOMINAL O.D. INCH (MM)	COMPONENT NO.	COMPONENT DESCRIPTIONS	CONDUCTORS COLOR CODE	COMPONENT NOMINAL O.D. INCH (MM)	INSULATION THICKNESS INCH (MM)
4ERS4S	0.430	1	4 Cond, 18 AWG, Shielded	White, Black, Red, Green	0.180 (4.572)	0.008 (0.2032)
		2	3 Pair, 22 AWG, Shielded	White & Green, Orange & Brown, Red & Black	0.195 (4.593)	0.008 (0.2032)
		3	2 Cond, 22 AWG, Shielded	Red, Black	0.125 (3.175)	0.008 (0.2032)
		4	4 Cond, 22 AWG, Shielded	White, Black, Red, Green	0.145 (3.683)	0.008 (0.2032)
4ERS1S	0.420	1	4 Cond, 18 AWG, Unshielded	White, Black, Red, Green	0.180 (4.572)	0.008 (0.2032)
		2	3 Pair, 22 AWG, Shielded	White & Green, Orange & Brown, Red & Black	0.195 (4.593)	0.008 (0.2032)
		3	2 Cond, 22 AWG, Unshielded	Red, Black	0.125 (3.175)	0.008 (0.2032)
		4	4 Cond, 22 AWG, Unshielded	White, Black, Red, Green	0.145 (3.683)	0.008 (0.2032)

Data subject to change.

JACKET COLOR CODING & COMPONENT APPLICATION

Jacket Color	Component	Cable Type	Application
Gray	1	4 Conductor, 18 AWG	Lock Power
Orange	2	3 Pair, 22 AWG	Card Reader
White	3	2 Conductor, 22 AWG	Door Contact
Blue	4	4 Conductor, 22 AWG	Rex/Spare

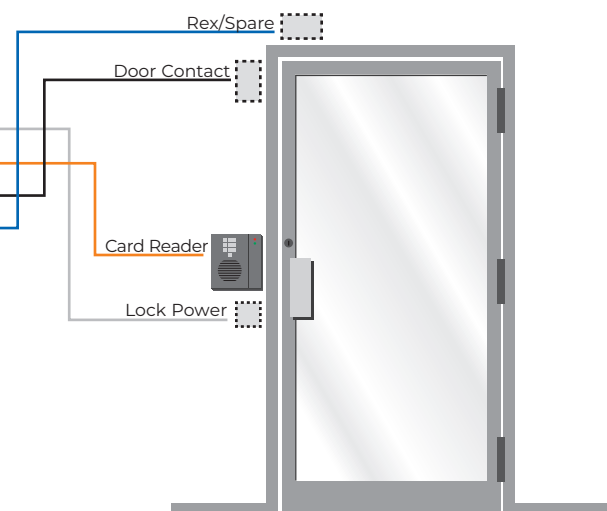

Multi-Conductor, Unshielded, Riser

NEC/CEC Type CMR and/or NEC Type CL3R and FPLR



Product Construction:

Conductor:

- Stranded or solid bare copper per ASTM B3, B8 and B286

Insulation:

- Premium-grade, color-coded PVC
- Color code: See chart below

Jacket:

- Premium-grade PVC, gray
- Sequential footage markings to facilitate installation
- Temperature range: -20°C to +105°C
- Includes ripcord

Applications:

- Power-limited control circuits
- Wiring of the following systems:
 - Intercom
 - Security
 - Audio
 - Background music
- Suggested voltage rating: 300 volts

Compliances:

- NEC Article 725 Type CL3R (UL: 105°C, 150 V)
- NEC Article 800 Type CMR (UL: 105°C, 300 V)
- NEC Article 760 Type FPLR (UL: 105°C, 300 V)
- RoHS Compliant Directive 2015/863/EU (RoHS-3)
- Suitable for use in the State of California

Packaging:

- Please contact Customer Service for packaging and color options

CATALOG NUMBER	NO. OF COND.	AWG SIZE	COND. STRAND	NOM. INSULATION THICKNESS		NOM. JACKET WALL		NOMINAL O.D.	
				in	mm	in	mm	in	mm
E1000S	2	22	Solid	0.007	0.20	0.015	0.38	0.118	3.00
E1001S	4	22	Solid	0.007	0.20	0.015	0.38	0.126	3.20
E1002S	2	22	7/30	0.008	0.20	0.015	0.38	0.122	3.10
E1003S	3	22	7/30	0.008	0.20	0.015	0.38	0.130	3.58
E1004S	4	22	7/30	0.008	0.20	0.015	0.38	0.141	3.66
E1006S	6	22	7/30	0.008	0.20	0.015	0.38	0.164	4.17
E1008S	8	22	7/30	0.008	0.20	0.015	0.38	0.180	4.57
E1010S	10	22	7/30	0.008	0.20	0.015	0.38	0.212	5.38
E1012S	12	22	7/30	0.008	0.20	0.015	0.38	0.219	5.56
E1022S	2	20	7/28	0.007	0.18	0.008	0.20	0.134	3.40
E1023S	3	20	7/28	0.008	0.20	0.015	0.38	0.142	3.61
E1024S	4	20	7/28	0.008	0.20	0.015	0.38	0.156	3.96
E1030S	2	18	Solid	0.008	0.20	0.015	0.38	0.144	3.66
E1032S	2	18	7/26	0.008	0.20	0.015	0.38	0.154	3.91
E1033S	3	18	7/26	0.008	0.20	0.015	0.38	0.163	4.14
E1034S	4	18	7/26	0.008	0.20	0.015	0.38	0.180	4.57
E1036S	6	18	7/26	0.008	0.20	0.015	0.38	0.216	5.49
E1038S	8	18	7/26	0.008	0.20	0.015	0.38	0.245	6.22
E1040S	10	18	7/26	0.008	0.20	0.015	0.38	0.282	7.16
E1041S	12	18	7/26	0.009	0.23	0.015	0.38	0.291	7.39
E1042S	2	16	19/0117	0.009	0.25	0.015	0.38	0.178	4.52
E1043S	3	16	19/0117	0.009	0.25	0.015	0.38	0.193	4.90
E1044S	4	16	19/0117	0.009	0.25	0.015	0.38	0.210	5.33
E1052S*	2	14	19/0147	0.013	0.33	0.015	0.38	0.224	5.69
E1054S*	4	14	19/0147	0.013	0.33	0.015	0.38	0.264	6.71
E1062S*	2	12	19/0185	0.013	0.33	0.015	0.38	0.260	6.60
E1064S*	4	12	19/0185	0.013	0.33	0.015	0.38	0.312	7.92

* NEC CL3R/FPLR only
Data subject to change.

COLOR CODE CHART

NO. OF COND.	COLOR	NO. OF COND.	COLOR	NO. OF COND.	COLOR	NO. OF COND.	COLOR
1	Black	4	Green	7	Orange	10	Gray
2	Red	5	Brown	8	Yellow	11	Pink
3	White	6	Blue	9	Purple	12	Tan



Multi-Conductor, Shielded, Riser

NEC/CEC Type CMR and/or NEC Type CL3R and FPLR

Product Construction:

Conductor:

- Stranded or solid bare copper per ASTM B3, B8 and B286

Insulation:

- Premium-grade, color-coded PVC
- Color code: See chart below

Shield:

- Overall Flexfoil® polyester supported aluminum foil
- Stranded tinned copper drain wire

Jacket:

- Premium-grade PVC, gray
- Sequential footage markings to facilitate installation
- Temperature range: -20°C to +105°C
- Includes ripcord

Applications:

- Power-limited control circuits
- Wiring of the following systems:
 - Intercom
 - Security
 - Audio
 - Background music
- Suggested voltage rating: 300 volts

Compliances:

- NEC Article 725 Type CL3R (UL: 105°C, 300 V)
- NEC Article 800 Type CMR (UL: 105°C, 300 V)
- NEC Article 760 Type FPLR (UL: 105°C, 300 V)
- RoHS Compliant Directive 2015/863/EU (RoHS-3)
- Suitable for use in the State of California

Packaging:

- Please contact Customer Service for packaging and color options



CATALOG NUMBER	NO. OF COND.	AWG SIZE	COND. STRAND	NOM. INSULATION THICKNESS		NOM. JACKET WALL		NOMINAL O.D.	
				in	mm	in	mm	in	mm
E2000S	2	22	Solid	0.008	0.20	0.015	0.38	0.117	2.97
E2002S	2	22	7/30	0.008	0.20	0.015	0.38	0.132	3.35
E2003S	3	22	7/30	0.008	0.20	0.015	0.38	0.135	3.43
E2004S	4	22	7/30	0.008	0.20	0.015	0.38	0.147	3.73
E2006S	6	22	7/30	0.008	0.20	0.015	0.38	0.173	4.39
E2008S	8	22	7/30	0.008	0.20	0.015	0.38	0.195	4.95
E2010S	10	22	7/30	0.008	0.20	0.015	0.38	0.218	5.54
E2012S	12	22	7/30	0.010	0.25	0.008	0.20	0.222	5.64
E2022S	2	20	7/28	0.007	0.18	0.008	0.20	0.142	3.61
E2023S	3	20	7/28	0.007	0.18	0.008	0.20	0.151	3.84
E2024S	4	20	7/28	0.007	0.18	0.008	0.20	0.161	4.09
E2030S	2	18	Solid	0.009	0.20	0.008	0.20	0.147	3.73
E2032S	2	18	7/26	0.008	0.20	0.015	0.38	0.159	4.04
E2033S	3	18	7/26	0.008	0.20	0.015	0.38	0.168	4.27
E2034S	4	18	7/26	0.008	0.20	0.015	0.38	0.184	4.67
E2036S	6	18	7/26	0.008	0.20	0.015	0.38	0.221	5.61
E2038S	8	18	7/26	0.008	0.20	0.015	0.38	0.240	6.10
E2040S	10	18	7/26	0.008	0.20	0.015	0.38	0.287	7.29
E2041S	12	18	7/26	0.008	0.20	0.015	0.38	0.296	7.52
E2042S	2	16	19/0117	0.009	0.23	0.015	0.38	0.189	4.80
E2043S	3	16	19/0117	0.009	0.23	0.015	0.38	0.198	5.03
E2044S	4	16	19/0117	0.009	0.23	0.015	0.38	0.219	5.56
E2052S*	2	14	19/0147	0.013	0.33	0.015	0.38	0.245	6.22
E2054S*	4	14	19/0147	0.013	0.33	0.015	0.38	0.269	6.83
E2062S*	2	12	19/0185	0.013	0.33	0.015	0.38	0.281	7.14
E2064S*	4	12	19/0185	0.013	0.33	0.015	0.38	0.312	7.92

* NEC CL3R/FPLR only
Data subject to change.

COLOR CODE CHART 5

NO. OF COND.	COLOR	NO. OF COND.	COLOR	NO. OF COND.	COLOR	NO. OF COND.	COLOR
1	Black	4	Green	7	Orange	10	Gray
2	Red	5	Brown	8	Yellow	11	Pink
3	White	6	Blue	9	Purple	12	Tan



Multi-Conductor, Unshielded, Plenum

NEC/CEC Type CMP and/or NEC Type CL3P and FPLP

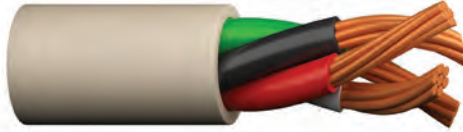

Product Construction:

Conductor:

- Stranded or solid bare copper per ASTM B3, B8 and B286

Insulation:

- Premium-grade, color-coded Flexguard® PVC
- Color code: See chart below

Jacket:

- Premium-grade Flexguard® PVC, natural
- Sequential footage markings to facilitate installation
- Temperature range: -20°C to +75°C

Applications:

- Power-limited control circuits
- Wiring of the following systems:
 - Intercom
 - Security
 - Audio
 - Background music
- Suggested voltage rating: 300 volts

Compliances:

- NEC Article 725 Type CL3P (UL: 75°C, 150 V)
- NEC Article 800 Type CMP (UL: 75°C, 300 V)
- NEC Article 760 Type FPLP (UL: 75°C, 300 V)
- Suitable for use in the State of California

Packaging:

- Please contact Customer Service for packaging and color options

CATALOG NUMBER	NO. OF COND.	AWG SIZE	COND. STRAND	NOM. INSULATION THICKNESS		NOM. JACKET WALL		NOMINAL O.D.	
				in	mm	in	mm	in	mm
E3000S	2	22	Solid	0.007	0.18	0.015	0.38	0.108	2.74
E3001S	4	22	Solid	0.007	0.18	0.015	0.38	0.124	3.15
E3002S	2	22	7/30	0.008	0.20	0.015	0.38	0.120	3.05
E3003S	3	22	7/30	0.008	0.20	0.015	0.38	0.127	3.23
E3004S	4	22	7/30	0.008	0.20	0.015	0.38	0.139	3.53
E3006S	6	22	7/30	0.008	0.20	0.015	0.38	0.164	4.17
E3008S	8	22	7/30	0.008	0.20	0.015	0.38	0.178	4.52
E3010S	10	22	7/30	0.008	0.20	0.015	0.38	0.194	4.92
E3012S	12	22	7/30	0.008	0.20	0.015	0.38	0.211	5.36
E3022S	2	20	7/28	0.009	0.23	0.015	0.20	0.134	3.40
E3023S	3	20	7/28	0.009	0.23	0.015	0.20	0.142	3.61
E3024S	4	20	7/28	0.009	0.23	0.015	0.20	0.156	3.96
E3030S	2	18	Solid	0.008	0.20	0.015	0.38	0.142	3.61
E3032S	2	18	7/26	0.008	0.20	0.015	0.38	0.156	3.96
E3033S	3	18	7/26	0.008	0.20	0.015	0.38	0.166	4.22
E3034S	4	18	7/26	0.008	0.20	0.015	0.38	0.187	4.75
E3036S	6	18	7/26	0.008	0.20	0.015	0.38	0.216	5.49
E3038S	8	18	7/26	0.008	0.20	0.015	0.38	0.235	5.97
E3042S	2	16	19/0117	0.008	0.20	0.015	0.38	0.174	4.42
E3043S	3	16	19/0117	0.008	0.20	0.015	0.38	0.185	4.70
E3044S	4	16	19/0117	0.009	0.23	0.008	0.20	0.205	5.21
E3052S*	2	14	19/0147	0.011	0.28	0.015	0.38	0.216	5.49
E3054S*	4	14	19/0147	0.011	0.28	0.015	0.38	0.255	6.48
E3062S*	2	12	19/0185	0.011	0.28	0.015	0.38	0.252	6.40
E3064S*	4	12	19/0185	0.011	0.28	0.015	0.38	0.298	7.57

* NEC CL3P/FPLP only
Data subject to change.

COLOR CODE CHART

NO. OF COND.	COLOR	NO. OF COND.	COLOR	NO. OF COND.	COLOR	NO. OF COND.	COLOR
1	Black	4	Green	7	Orange	10	Gray
2	Red	5	Brown	8	Yellow	11	Pink
3	White	6	Blue	9	Purple	12	Tan



Multi-Conductor, Shielded, Plenum

NEC/CEC Type CMP and/or NEC Type CL3P and FPLP

Product Construction:

Conductor:

- Stranded or solid bare copper per ASTM B3, B8 and B286

Insulation:

- Premium-grade, color-coded Flexguard® PVC

Shield:

- Overall Flexfoil® polyester supported aluminum foil
- Stranded tinned copper drain wire

Jacket:

- Premium-grade Flexguard® PVC, natural
- Sequential footage markings to facilitate installation
- Temperature range: -20°C to +75°C

Applications:

- Power-limited control circuits
- Wiring of the following systems:
 - Intercom
 - Security
 - Audio
 - Background music
- Suggested voltage rating: 300 volts

Compliances:

- NEC Article 725 Type CL3P (UL: 75°C, 150 V)
- NEC Article 800 Type CMP (UL: 75°C, 300 V)
- NEC Article 760 Type FPLP (UL: 75°C, 300 V)
- Suitable for use in the State of California

Packaging:

- Please contact Customer Service for packaging and color options



CATALOG NUMBER	NO. OF COND.	AWG SIZE	COND. STRAND	NOM. INSULATION THICKNESS		NOM. JACKET WALL		NOMINAL O.D.	
				in	mm	in	mm	in	mm
E2100S	2	22	Solid	0.007	0.18	0.015	0.38	0.116	2.95
E2102S	2	22	7/30	0.008	0.20	0.015	0.38	0.128	3.25
E2103S	3	22	7/30	0.008	0.20	0.015	0.38	0.131	3.33
E2104S	4	22	7/30	0.008	0.20	0.015	0.38	0.147	3.73
E2106S	6	22	7/30	0.008	0.20	0.015	0.38	0.176	4.47
E2108S	8	22	7/30	0.008	0.20	0.015	0.38	0.184	4.67
E2110S	10	22	7/30	0.008	0.20	0.015	0.38	0.215	5.46
E2112S	12	22	7/30	0.008	0.20	0.015	0.38	0.222	5.64
E2122S	2	20	7/28	0.009	0.23	0.015	0.20	0.139	3.53
E2123S	3	20	7/28	0.009	0.23	0.015	0.20	0.147	3.73
E2124S	4	20	7/28	0.009	0.23	0.015	0.20	0.161	4.09
E2200S	2	18	Solid	0.008	0.20	0.015	0.38	0.148	3.76
E2202S	2	18	7/26	0.008	0.20	0.015	0.38	0.164	4.17
E2203S	3	18	7/26	0.008	0.20	0.015	0.38	0.169	4.29
E2204S	4	18	7/26	0.008	0.20	0.015	0.38	0.185	4.70
E2206S	6	18	7/26	0.010	0.25	0.008	0.20	0.218	5.54
E2208S	8	18	7/26	0.010	0.25	0.008	0.20	0.237	6.02
E2242S	2	16	19/0117	0.008	0.20	0.015	0.38	0.179	4.55
E2243S	3	16	19/0117	0.008	0.20	0.015	0.38	0.190	4.83
E2244S	4	16	19/0117	0.008	0.20	0.015	0.38	0.209	5.31
E2252S*	2	14	19/0147	0.008	0.20	0.011	0.28	0.235	5.97
E2254S*	4	14	19/0147	0.008	0.20	0.011	0.28	0.260	6.60
E2262S*	2	12	19/0185	0.008	0.20	0.011	0.28	0.257	6.53
E2264S*	4	12	19/0185	0.008	0.20	0.011	0.28	0.303	7.70

* NEC CL3P/FPLP only
Data subject to change.

COLOR CODE CHART

NO. OF COND.	COLOR	NO. OF COND.	COLOR	NO. OF COND.	COLOR	NO. OF COND.	COLOR
1	Black	4	Green	7	Orange	10	Gray
2	Red	5	Brown	8	Yellow	11	Pink
3	White	6	Blue	9	Purple	12	Tan



Telephone Station/Intercom & Speaker Burglar Alarm

NEC Types CMR or CM/CL2 and CMX-Outdoor

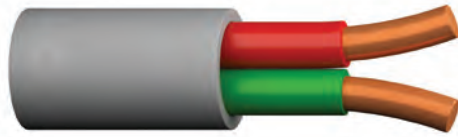

CATALOG NUMBER	NO. OF COND.	AWG SIZE	COND. STRAND	NOM. INSULATION THICKNESS		NOM. JACKET THICKNESS		NOMINAL O.D.	
				in	mm	in	mm	in	mm
INTERCOM, SPEAKER AND BURGLAR ALARM									
C4408*	2	22	Solid	0.007	0.18	0.020	0.51	0.115	2.92
C4408ST*	2	22	7/0096	0.007	0.18	0.020	0.51	0.125	3.18
C4410	3	22	Solid	0.007	0.18	0.016	0.41	0.118	3.00
C4412*	4	22	Solid	0.007	0.18	0.015	0.38	0.125	3.18
C4412ST*	4	22	7/0096	0.007	0.18	0.015	0.38	0.135	3.43

COLOR CODE CHART

NO. OF COND.	COLOR
1	Red
2	Green
3	Yellow
4	Black

TELEPHONE STATION CATEGORY 3

CATALOG NUMBER	NO. OF PAIRS	AWG SIZE	COND. STRAND	NOM. INSULATION THICKNESS		NOM. JACKET THICKNESS		NOMINAL O.D.	
				in	mm	in	mm	in	mm
C4413	2	24	Solid	0.007	0.18	0.015	0.38	0.145 x 0.095	3.68 x 2.41

Note: Outdoor rating allows cable to be exposed for short distances from the network interface device on the outside of the house to the point where the cable enters the house. This type of cable is not to be buried or direct buried.

Data subject to change.

COLOR CODE CHART (Bandmarked)

NO. OF COND.	COLOR
1	White-Blue Band Blue
2	White-Orange Band Orange

Product Construction:

Conductor:

- Solid or stranded bare copper per ASTM B3

Insulation:

- Semi-rigid, flame-retardant PVC
- Color code: See chart below

Core:

- Conductors in a quad configuration (C4412)

Jacket:

- Low-temperature, flame-retardant beige PVC (-20°C to +105°C)
- Sequential footage markings
- Cables are suitable for installation with T-18 staples

Applications:

- Intercom systems and speaker extension service
- Suggested voltage rating: 300 volts
- C4413 only: Product is in conformance with TIA 568C, TIA 570B standards and the FCC Part 68 ruling which requires telephone system cables for voice and data services into homes to be at minimum category 3, 2 pr. 22 AWG solid

Compliances:

- NEC Article 800 Type CMR/CMX-Indoor/Outdoor; UL Listed (105°C, 300 V)
- C4413 only, Category 3
- RoHS Compliant Directive 2015/863/EU (RoHS-3)

Packaging:

- Please contact Customer Service for packaging and color options

Thermostat Wire

60°C 30 Volt CSA Type LVT

Product Construction:

Conductors:

- 18 AWG annealed solid bare copper per ASTM B3

Insulation:

- Premium-grade, color-coded PVC
- Color code: See chart below

Jacket:

- Polyvinylchloride (PVC), brown
- Temperature range: -20°C to +60°C

Jacket Marking:

- CAROL (SIZE) CSA LL# TYPE LVT FT4

Applications:

- Thermostat control
- Heating and air conditioning installations
- Touch-plate systems
- Burglar alarms
- Intercom systems
- Door bells
- Annunciator and bell systems
- Remote control units
- Signal systems
- Other low-voltage installations

Industry Approvals:

- CSA Type LVT

Packaging:

- 4- through 10-conductor available on 250' (76.2 m) spools
- 2- and 3-conductor available on 500' (152.4 m) spools
- Other put-ups available on special order

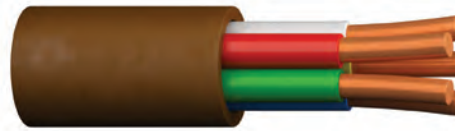

18 AWG THERMOSTAT WIRE – 30 VOLT – CSA TYPE LVT

CATALOG NUMBER	NO. OF COND.	AWG SIZE	COND. STRAND	NOMINAL INS. THICKNESS		NOMINAL O.D.		APPROX. NET WEIGHT LBS/M ⁽⁵⁾	STD. CTN.
				in	mm	in	mm		
05092	2	18	Solid	0.016	0.41	0.210	5.33	25	2000'
05093*	3	18	Solid	0.016	0.41	0.220	5.59	33	500'
05094	4	18	Solid	0.016	0.41	0.242	6.15	41	1000'
05095	5	18	Solid	0.016	0.41	0.262	6.65	50	1000'
05096*	6	18	Solid	0.016	0.41	0.280	7.11	60	1000'
05097*	7	18	Solid	0.016	0.41	0.285	7.24	65	1000'
05098	8	18	Solid	0.016	0.41	0.304	7.75	74	1000'
05099*	9	18	Solid	0.016	0.41	0.328	8.33	83	1000'
05091*	10	18	Solid	0.016	0.41	0.360	9.14	92	250'

* Non-stock item; minimum quantity purchase required.

⁽⁵⁾ Actual shipping weight may vary.

Data subject to change.

COLOR CODE CHART

NO. OF COND.	COLOR
2	White, Red
3	White, Red, Green
4	White, Red, Green, Blue
5	White, Red, Green, Blue, Yellow
6	White, Red, Green, Blue, Yellow, Brown
7	White, Red, Green, Blue, Yellow, Brown, Orange
8	White, Red, Green, Blue, Yellow, Brown, Orange, Black
9	White, Red, Green, Blue, Yellow, Brown, Orange, Black, Purple
10	White, Red, Green, Blue, Yellow, Brown, Orange, Black, Purple, Gray

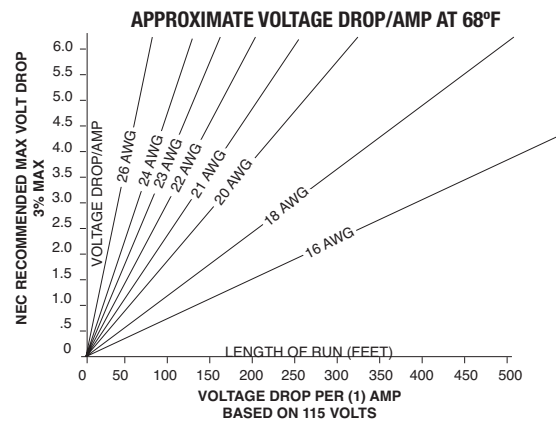

Thermostat Wire

105°C 150 Volt UL Type CL2

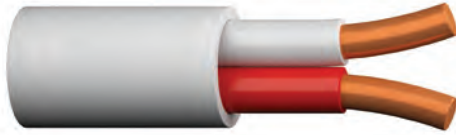

20 AWG THERMOSTAT WIRE – 150 VOLT – UL TYPE CL2

CATALOG NUMBER	NO. OF COND.	AWG SIZE	COND. STRAND	NOMINAL INS. THICKNESS		NOMINAL O.D.		APPROX. NET WEIGHT LBS/M ⁽⁵⁾	STD. CTN.
				in	mm	in	mm		
05482	2	20	Solid	0.008	0.203	0.126	3.20	11	1000'
05483	3	20	Solid	0.008	0.203	0.133	3.38	16	1000'
05484	4	20	Solid	0.008	0.203	0.142	3.61	19	500'
05485	5	20	Solid	0.008	0.203	0.160	4.06	24	500'
05486	6	20	Solid	0.008	0.203	0.175	4.45	27	500'
05487	7	20	Solid	0.008	0.203	0.175	4.45	31	500'
05488	8	20	Solid	0.008	0.203	0.189	4.80	35	500'
05489*	9	20	Solid	0.008	0.203	0.204	5.18	40	500'
05481*	10	20	Solid	0.008	0.203	0.222	5.64	45	250'

18 AWG THERMOSTAT WIRE – 150 VOLT – UL TYPE CL2

CATALOG NUMBER	NO. OF COND.	AWG SIZE	COND. STRAND	NOMINAL INS. THICKNESS		NOMINAL O.D.		APPROX. NET WEIGHT LBS/M ⁽⁵⁾	STD. CTN.
				in	mm	in	mm		
05582	2	18	Solid	0.008	0.203	0.142	3.61	16	1000'
05583	3	18	Solid	0.008	0.203	0.150	3.81	22	1000'
05584	4	18	Solid	0.008	0.203	0.165	4.19	28	500'
05585	5	18	Solid	0.008	0.203	0.181	4.60	36	500'
05586	6	18	Solid	0.008	0.203	0.208	5.28	42	500'
05587	7	18	Solid	0.008	0.203	0.208	5.28	48	500'
05588	8	18	Solid	0.008	0.203	0.225	5.72	54	500'
05589*	9	18	Solid	0.008	0.203	0.243	6.17	61	500'
05581	10	18	Solid	0.008	0.203	0.264	6.71	69	250'

⁽⁵⁾ Actual shipping weight may vary.
Data subject to change.

Product Construction:

Conductors:

- 20 and 18 AWG annealed solid bare copper per ASTM B3

Insulation:

- Premium-grade, color-coded PVC
- Color code: See chart below

Jacket:

- Polyvinylchloride (PVC), white
- Temperature range: -20°C to +105°C

Jacket Marking:

- CAROL AWG TYPE CL2 E# (UL) 105°C SUNLIGHT RESISTANT - MADE IN USA

Applications:

- Thermostat control
- Heating and air conditioning installations
- Touch-plate systems
- Burglar alarms
- Intercom systems
- Door bells
- Annunciator and bell systems
- Remote control units
- Signal systems
- Other low-voltage installations

Industry Approvals:

- UL Listed Type CL2
- RoHS Compliant

Packaging:

- 4- through 10-conductor available on 250' (76.2 m) spools
- 2- and 3-conductor available on 500' (152.4 m) spools
- Other put-ups available on special order

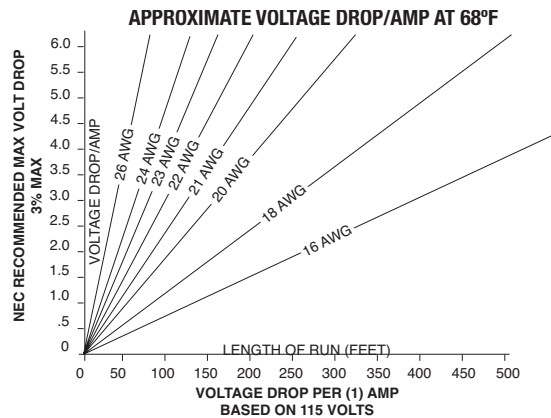

COLOR CODE CHART

NO. OF COND.	COLOR
2	White, Red
3	White, Red, Green
4	White, Red, Green, Blue
5	White, Red, Green, Blue, Yellow
6	White, Red, Green, Blue, Yellow, Brown
7	White, Red, Green, Blue, Yellow, Brown, Orange
8	White, Red, Green, Blue, Yellow, Brown, Orange, Black
9	White, Red, Green, Blue, Yellow, Brown, Orange, Black, Purple
10	White, Red, Green, Blue, Yellow, Brown, Orange, Black, Purple, Gray



Thermostat Wire, Unjacketed

60°C Low Voltage and Intercom Cable

Product Construction:

Conductors:

- 20 AWG annealed solid bare copper per ASTM B3

Insulation:

- Premium-grade, color-coded PVC
- Temperature range: -20°C to +60°C
- Color code: See chart below

Jacket:

- This product is unjacketed

Applications:

- Thermostat control
- Heating and air conditioning installations
- Touch-plate systems
- Burglar alarms
- Intercom systems
- Door bells
- Annunciator and bell systems
- Remote control units
- Signal systems
- Other low-voltage installations

Packaging:

- 4- through 8-conductor available on 250' (76.2 m) spools
- 2- and 3-conductor available on 500' (152.4 m) spools
- Other put-ups available on special order



20 AWG – TWISTED CONDUCTORS – NO JACKET

CATALOG NUMBER	NO. OF COND.	AWG SIZE	COND. STRAND	NOMINAL INS. THICKNESS		NOMINAL O.D.		APPROX. NET WEIGHT LBS/M ⁽⁵⁾	STD. CTN.
				in	mm	in	mm		
05782	2	20	Solid	0.008	0.203	0.096	2.44	7.5	4000'
05783	3	20	Solid	0.008	0.203	0.104	2.64	11.0	2000'
05784*	4	20	Solid	0.008	0.203	0.116	2.95	15.0	2000'
05785*	5	20	Solid	0.008	0.203	0.130	3.30	18.5	1000'
05786*	6	20	Solid	0.008	0.203	0.144	3.66	22.0	1000'
05788*	8	20	Solid	0.008	0.203	0.159	4.04	30.0	1000'

* Non-stock item; minimum quantity purchase required.
⁽⁵⁾ Actual shipping weight may vary.
 Data subject to change.

COLOR CODE CHART

NO. OF COND.	COLOR
2	White, Red
3	White, Red, Green
4	White, Red, Green, Blue
5	White, Red, Green, Blue, Yellow
6	White, Red, Green, Blue, Yellow, Brown
7	White, Red, Green, Blue, Yellow, Brown, Orange
8	White, Red, Green, Blue, Yellow, Brown, Orange, Black



Category Cables

7

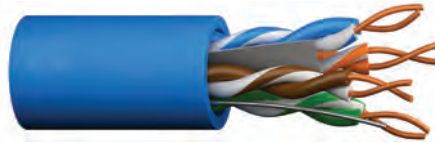

For more than a century and a half, Prysmian has stayed ahead of the industry's changing needs with products that anticipate future performance requirements and provide best value in cabling solutions. With the ever-increasing need for readily available information in our lives, CAROL® Brand Category Cables transmit data through computer and telecommunications systems and are available in a variety of performance levels and constructions, including Category 6 and Category 5e cables.

Prysmian's Carol® MAX Category 6 Cable is a cost effective, extended distance 22 AWG cable that provides power and bandwidth beyond IEEE standards. Perfect for making it easier to connect complex network systems with high-powered PoE capabilities. Carol® 6 MAX delivers 1 Gbps at up to 200 meters certified by Third Party Testers.

Next, our Category 6 cables have been enhanced to provide the market with a cost-effective, high-bandwidth and high-performance cabling solution for more robust and complex applications at Gigabit speed and full duplex transmissions. Our Cat 6 solutions provides a cable system infrastructure with assurance for advanced applications demanding more bandwidth.

Finally, with steady, continuous performance, our Category 5e solutions meet all Cat 5e requirements for present and future network requirements ensuring increased headroom, lower bit-error rates and higher signal transmission quality.

All CAROL Brand Category Cables are safety listed to the NEC and CEC requirements, and most are verified for electrical performance. This independent third party testing further confirms the quality and performance of Prysmian products.

Section	Page
Category 6 Cable - Carol MAX	107-108
Category 6 Cable	109
Category 5e Cable	110

Category 6 Cable – Carol MAX

Extended Distance (22 AWG)

Product Construction:

Conductors:

- 22 AWG solid bare annealed copper

Separator:

- CMP: Divider
- OSP: Cross-web

Insulation:

- CMP: Fluoropolymer
- OSP: Polyolefin

Jacket:

- CMP: Low-Smoke, Flame-Retardant PVC
- OSP: UV- and abrasion-resistant polyethylene

Applications:

- IEEE 802.3; 1000 Base-T, 100 Base-TX, 10 Base-T, PoE, PoE+, PoE++
- ANSI/TIA 854; 1000 Base-TX
- CDDI, Token Ring, ATM
- Digital Video
- Broadband a Baseband Analog Video
- OSP: Duct and conduit installations
- Supports the growth of higher-wattage devices (IT/IP, IoT, and IoE)
- CMP: Compatible with new higher-speed, higher-power USB 3.1 SuperSpeed

Compliances:

- ANSI/TIA 568.2-D
- CMP: TIA TSB-184:2009
- UL 444
- RoHS Compliant Directive 2011/65 EU
- ANSI/TIA 862 (Building Automation)
- ICEA S-116-732
- ICEA S-102-700
- ISO/IEC 11801 Ed. 2.0 (Class E)
- OSP: Telcordia (Bellcore) Specification GR-421-CORE Water Penetration Requirement

Packaging:

- 1000' Spool-Pac®



PART NUMBERS

JACKET COLOR	CMP (Plenum)		OSP (Outside Plant)
	PULL-PAC®	SPOOL-PAC®	SPOOL-PAC®
Blue	CP622.30.07	CP622.A3.07	N/A
White	CP622.30.02	CP622.A3.02	N/A
Gray	CP622.30.10	CP622.A3.10	N/A
Green	CP622.30.06	CP622.A3.06	N/A
Yellow	CP622.30.05	CP622.A3.05	N/A
Red	CP622.30.03	CP622.A3.03	N/A
Black	CP622.30.01	CP622.A3.01	CX622.A3.01

ELECTRICAL PERFORMANCE

FREQUENCY MHZ	PSACR (MIN)	ACR (MIN)	INSERTION LOSS (MAX)	PSNEXT (MIN)	NEXT (MIN)	RETURN LOSS (MIN)	TCL (MIN)
1	70.4	72.4	1.9	72.3	74.3	20.0	40.0
4	59.8	61.8	3.5	63.3	65.3	23.0	40.0
10	51.8	53.8	5.5	57.3	59.3	25.0	40.0
16	47.2	49.2	7.0	54.2	56.2	25.0	38.0
20	44.9	46.9	7.9	52.8	54.8	25.0	37.0
31.25	40.0	42.0	9.9	49.9	51.9	23.6	35.1
62.5	31.1	33.1	14.3	45.4	47.4	21.5	32.0
100	23.9	25.9	18.4	42.3	44.3	20.1	28.2
150	16.7	18.7	23.0	39.7	41.7	18.9	27.0
200	10.8	12.8	27.0	37.8	39.8	18.0	26.0
250	5.7	7.7	30.6	36.3	38.3	17.3	-

Note: Values are expressed in dB per 100m (328 ft.) length @ 20° C.

CMP

CATEGORY 6 CROSS-SECTION

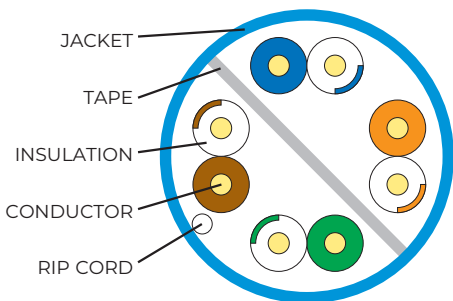

OSP

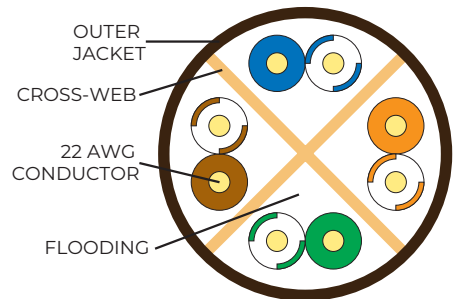

PHYSICAL DATA

	PLENUM	OSP
Nominal Cable Diameter (in)	0.245	0.295
Nominal Cable Weight (lbs/1000ft)	38	40
Minimum Bend Radius (in)	1.0	1.0
Maximum Pulling Force (lbs)	32	32
Temperature Rating (°C)		
Installation:	0 to +60	-30 to +60
Operation:	-20 to +75	-45 to +80

ELECTRICAL CHARACTERISTICS

	MAX	OSP
DC Resistance Ohms/100m (328ft) @ 20° C	9.38	6.50
DC Resistance Unbalance Individual Pair %	4.00	< 1
Delay Skew ns/100m	45	35
Nom. Velocity of Propagation % Speed of Light	CMP: 72% OSP: 66%	
Characteristic Impedance Frequency (f):	1-350 MHz	Ohms 100 ± 15



Carol MAX

Cat 6 Extended Distance (22 AWG)

FEATURING
EFFICIENCY MAX[®]
technology to support PoE applications





Carol[®] 6 MAX Category 6 (22 AWG) cables provide maximum versatility to challenging installations with a Plenum and Outside Plant cable option. The cable meets all Category 6 requirements under 100 meters. It also provides power and bandwidth at extended distances beyond the IEEE standard. The same industry-trusted high-powered PoE cable that has been in the market since 2015 is now guaranteed to meet your extended distance needs.

Primary enhancement—larger copper (22 AWG)

- Less voltage drop
- Increased current-carrying capacity
- Performs better in hotter environments (less heat generation)

CAROL[®] 6 MAX delivers
1 Gbps at up to
200 meters certifiable
by Third Party Testers

Exceeds the 100-meter Category Cable limitations distance while meeting all your application needs:

	ITC	AV SYSTEMS IP PHONES
	SECURITY	4K CAMERAS ACCES CONTROL
	IoT DEVICES	RETAIL TEMPERATURE/HUMIDITY CONTROLS
	BUILDING AUTOMATION	PARKING SYSTEMS BUILDING SYSYSTEMS

Performance expectations can vary based on application and temperature. The below table is a guide to the max distance in your installation:

Type 1 PoE (802.3af) up to 15.4W – ex. VoIP and Cameras
 Type 2 PoE (802.3at) up to 30W – ex. Video IP Phones, Alarm Systems, Heated / PTZ Cameras
 Type 3/Type 4 PoE (802.3bt) up to 60W/90W – ex. WiFi, Laptops, 8k Cameras

CAROL [®] MAX Cable**	PoE @ Ambient Temp			
	Type 1	Type 2	Type 3	Type 4
Max Distance @ 10 Mbps	274m	250m	250m	250m
Max Distance @ 100 Mbps	230m	230m	230m	230m
Max Distance @ 1Gbps	200m	200m	200m	200m

**Maximum distance is subject to change based on manufacturer's equipment and other environmental conditions.



Category 6 Cable

Standard-Compliant Solution

Product Construction:

Conductors:

- Non-Plenum: 23 AWG sold bare annealed copper
- Plenum: 24 AWG sold bare annealed copper

Insulation:

- Non-Plenum: Polyolefin
- Plenum: Fluoropolymer

Separator:

- Tape

Rip Cord:

- Applied longitudinally under jacket

Jacket:

- Non-Plenum: flame-retardant PVC
- Plenum: low-smoke, flame-retardant PVC
- TRU-Mark® print legend contains footage markings from 1000' to 0'

Applications:

- IEEE 802.3: 1000 BASE-T (Gigabit Ethernet), 100 BASE-TX, 10 BASE-T
- ANSI/TIA/EIA 854: 1000 BASE-TX
- 155 Mp/s, 1.2 Gb/s ATM
- ANSI X3.263: 100 Mb/s
- IEEE 802.3af DTE Power (PoE)
- Digital video

Compliances:

- ANSI/TIA 568 B.2-1 (Category 6)
- ANSI/TIA 862 (Building Automation)
- ISO/IEC 11801 Ed. 2.0 (Class E)
- ICEA S-102-700 (Category 6)
- Type CMP (NFPA 262 and CSA FT6 Steiner Tunnel Fire Tests for Plenum Applications)
- UL 444
- NEC/CEC Type CMP (NFPA 262 and CSA FT6 Steiner Tunnel Fire Tests for Plenum Applications)
- NEC/CEC Type CMR (UL 1666) for Non-Plenum
- RoHS Compliant Directive 2011/65/EU
- Third-party verified for guaranteed performance

Packaging:

- 1000' Pull-Pac® II
- 1000' Spool-Pac®

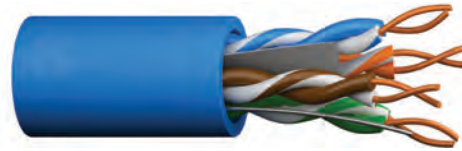

PART NUMBERS

JACKET COLOR	PULL-PAC® II		SPOOL-PAC®	
	CMR (NON-PLENUM)	CMP (PLENUM)	CMR (NON-PLENUM)	CMP (PLENUM)
Blue	CR6.30.07	CP6.30.07	CR6.A3.07	CP6.A3.07
White	CR6.30.02	CP6.30.02	CR6.A3.02	CP6.A3.02
Gray	CR6.30.10	CP6.30.10	CR6.A3.10	CP6.A3.10
Green	CR6.30.06	CP6.30.06	CR6.A3.06	CP6.A3.06
Yellow	CR6.30.05	CP6.30.05	CR6.A3.05	CP6.A3.05
Red	CR6.30.03	CP6.30.03	CR6.A3.03	CP6.A3.03

ELECTRICAL PERFORMANCE

FREQUENCY MHZ	PSACR (MIN)	ACR (MIN)	ATTENUATION (MAX)	PSNEXT (MIN)	NEXT (MIN)	PSELFEXT (MIN)	ELFEXT (MIN)	RETURN LOSS (MIN)	LCL (MIN)	ELTCTL (MIN)
1	70.3	72.3	2.0	72.3	74.3	64.8	67.8	20.0	40.0	35.0
4	59.3	61.5	3.8	63.3	65.3	52.8	55.7	23.0	40.0	23.0
10	51.3	53.3	6.0	57.3	59.3	44.8	47.8	25.0	40.0	15.0
16	46.7	48.7	7.6	54.2	56.2	40.7	43.7	25.0	38.0	10.9
20	44.3	46.3	8.5	52.8	54.8	38.8	41.7	25.0	37.0	9.0
31.25	39.2	41.2	10.7	49.9	51.9	34.9	37.9	23.6	35.1	5.1
62.5	29.9	32.0	15.4	45.4	47.4	28.9	31.8	21.5	32.0	5.0
100	22.5	24.5	19.8	42.3	44.3	24.8	27.8	20.1	30.0	5.0
150	14.9	16.9	24.7	39.7	41.7	21.3	24.3	18.9	28.2	5.0
200	8.8	10.8	29.0	37.8	39.8	18.8	21.8	18.0	27.0	5.0
250	3.5	5.5	32.8	36.3	38.3	16.8	19.8	17.3	26.0	5.0
350	—	—	39.8	34.1	36.1	13.9	16.9	16.3	—	—
400	—	—	43.0	33.3	35.3	12.8	15.8	15.9	—	—
500	—	—	48.9	31.8	33.8	10.8	13.8	15.2	—	—

Notes: Values are expressed in dB per 100m (328 ft) length. Values above 250 MHz are for informational purposes only.

PHYSICAL DATA

	CMR (NON-PLENUM)	CMP (PLENUM)
Nominal Cable Diameter (in)	0.220	0.205
Nominal Cable Weight (lbs/1000ft)	28	28
Minimum Bend Radius (in)	1.0	1.0
Maximum Pulling Force (lbs)	32	32
Temperature Rating (°C)		
Installation:	0 to +60	0 to +60
Operation:	-20 to +75	-20 to +75

ELECTRICAL CHARACTERISTICS

DC Resistance (max) Ohms/100m (328ft) @ 20° C	9.38
DC Resistance Unbalance (max) Individual Pair %	4.0
Delay Skew (max) ns/100m	45
Nom. Velocity of Propagation % Speed of Light	CMP: 70 CMR: 68
Characteristic Impedance Frequency (f):	Ohms 1-250 MHz 100 ± 15

Data subject to change.

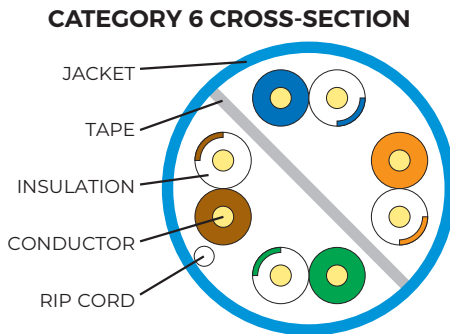

Designed to Meet NFPA 262 and CSA FT6 Steiner Tunnel Fire Tests for Plenum Applications

Underwriters Laboratories Inc.



Category 5e Cable

Enhanced Transmission Throughput

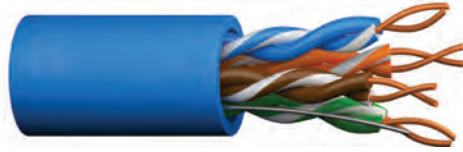

PART NUMBERS

JACKET COLOR	PULL-PAC® II		SPOOL-PAC®	
	CMR (NON-PLENUM)	CMP (PLENUM)	CMR (NON-PLENUM)	CMP (PLENUM)
Blue	CR5.30.07	CP5.30.07	CR5.A3.07	CP5.A3.07
White	CR5.30.02	CP5.30.02	CR5.A3.02	CP5.A3.02
Gray	CR5.30.10	CP5.30.10	CR5.A3.10	CP5.A3.10
Green	CR5.30.06	CP5.30.06	CR5.A3.06	CP5.A3.06
Yellow	CR5.30.05	CP5.30.05	CR5.A3.05	CP5.A3.05
Red	CR5.30.03	CP5.30.03	CR5.A3.03	CP5.A3.03

ELECTRICAL PERFORMANCE

FREQUENCY MHZ	PSACR (MIN)	ACR (MIN)	ATTENUATION (MAX)	PSNEXT (MIN)	NEXT (MIN)	PSELFEXT (MIN)	ELFEXT (MIN)	RETURN LOSS (MIN)
1	60.3	63.3	2.0	62.3	65.3	60.8	63.8	20.0
4	49.2	52.2	4.1	53.3	56.3	48.7	51.7	23.0
10	40.8	43.8	6.5	47.3	50.3	40.8	43.8	25.0
16	36.0	39.0	8.2	44.2	47.2	36.7	39.7	25.0
20	33.5	36.5	9.3	42.8	45.8	34.7	37.7	25.0
25	30.9	33.9	10.4	41.3	44.3	32.8	35.8	24.3
31.25	28.2	31.2	11.7	39.9	42.9	30.9	33.9	23.6
62.5	18.4	21.4	17.0	35.4	38.4	24.8	27.8	21.5
100	10.3	13.3	22.0	32.3	35.3	20.8	23.8	20.1
155	1.4	4.4	28.1	29.4	32.4	16.9	19.9	—
200	—	—	32.4	27.8	30.8	14.7	17.7	—
250	—	—	36.9	26.3	29.3	12.8	15.8	—
350	—	—	44.9	24.1	27.1	9.9	12.9	—

Notes: Values are expressed in dB per 100m (328 ft.) length. Values above 250 MHz are for informational purposes only.

PHYSICAL DATA

	CMR (NON-PLENUM)	CMP (PLENUM)
Nominal Cable Diameter (in)	0.200	0.180
Nominal Cable Weight (lbs/1000ft)	21	19
Minimum Bend Radius (in)	1.0	1.0
Maximum Pulling Force (lbs)	25	25
Temperature Rating (°C)		
Installation:	0 to +60	0 to +60
Operation:	-10 to +60	-10 to +60

ELECTRICAL CHARACTERISTICS

DC Resistance (max) Ohms/100m (328ft) @ 20 °C	9.38
DC Resistance Unbalance (max) Individual Pair %	4.0
Delay Skew (max) ns/100m	45
Nom. Velocity of Propagation % Speed of Light	CMP: 72 CMR: 70
Characteristic Impedance	Ohms
Frequency (f): 1-100 MHz	100 ± 15

Data subject to change.

Product Construction:

Conductors:

- 24 AWG solid bare annealed copper

Insulation:

- Non-Plenum: Polyolefin
- Plenum: Fluoropolymer

Rip Cord:

- Applied longitudinally under jacket

Jacket:

- Non-Plenum: flame-retardant PVC
- Plenum: low-smoke, flame-retardant PVC
- TRU-Mark® print legend contains footage markings from 1000' to 0'

Applications:

- IEEE 802.3: 1000 BASE-T (Gigabit Ethernet), 100 BASE-TX, 10 BASE-T
- 52/155 Mp/s ATM
- ANSI X3.263: 100 Mb/s
- 4/16 Mp/s token ring

Compliances:

- ANSI/TIA 568 B.2 (Category 5e)
- ICEA S-90-661 (Category 5e)
- Type CMR (UL 1666) for Non-Plenum
- NEC/CEC Type CMP (NFPA 262 and CSA FT6 Steiner Tunnel Fire Tests for Plenum Applications)
- UL 444
- RoHS Compliant Directive 2011/65/EU
- Third-party verified for guaranteed performance

Packaging:

- 1000' Pull-Pac® II
- 1000' Spool-Pac®

CATEGORY 5e CROSS-SECTION

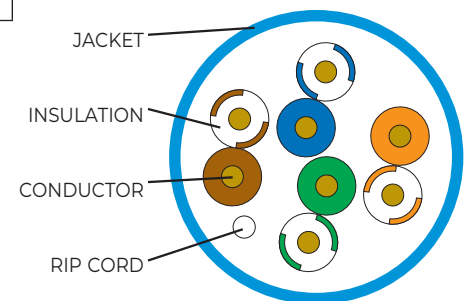

Designed to Meet
NFPA 262 and CSA FT6
Steiner Tunnel Fire Tests
for Plenum Applications
Underwriters Laboratories Inc.



Coaxial Cable

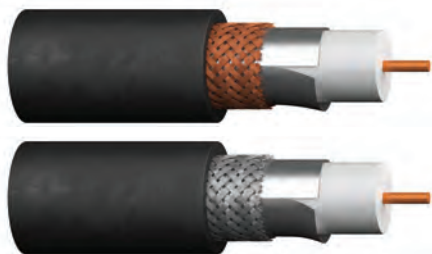

To meet the needs of today's sophisticated, high-speed, wide bandwidth electronics over long distances, with minimum signal loss or degradation, Prysmian CAROL® Brand offers a wide range of coaxial and twinaxial designs in both unbalanced arrays and precision-balanced pairs. This offers the system designer a wide choice of cost-effective products that reflect the most recent changes in the standards set by UL, CSA and/or the FCC.

Included in this section are recommended CAROL Brand coaxial products for the CATV market. However, these constructions may differ in certain parts of the country.

Unlike other products in the electronic market, coaxial cable does not have one accepted standard construction.

Prysmian recommends, in order to avoid installing an unacceptable coaxial cable for the CATV application in your area, the local CATV company should be consulted.

Prysmian's CAROL Brand product mix encompasses standard RG/U-type coaxial constructions in the more popular 50, 75 and 93 ohm designs and miniature coaxial products for smaller high-speed applications.

The twinaxial products meet or exceed the stringent demands of today's precision-balanced pair systems. The minimization of capacitance unbalance is a necessary requirement for long distance data transmission.

Section	Page
RG 6/U Type	112-116
RG 8/U Type	117
RG 11/U Type	118-120
RG 58/U Type	121
RG 59/U Type	122-126
RG 62/U Type	127
RG 174/U Type	128
RG 213/U Type	129
Twinaxial Cables	130

RG 6/U Type

Product Construction:

Conductors:

- Copper per ASTM B3
- Copper-clad steel per ASTM B869

Insulation/Core:

- Foam polyethylene (PE)

Shield:

- Bare copper or aluminum braid
- Flexfoil® shield

Jacket:



- Premium PVC compound

Packaging:

- Please contact Customer Service for packaging and color options

Applications:

- Suitable for RF signal transmission
- MATV
- CATV
- CCTV†
- HDTV
- Digital video
- Drop cable
- FM broadcast

CATALOG NUMBER	AWG SIZE NOM. DCR	INSULATION O.D.		SHIELD COVERAGE NOM SHLD DCR	NOMINAL O.D.		NOMINAL CAPACITANCE		VELOCITY OF PROPAGATION, %	NOMINAL IMPEDANCE, Ω	NOMINAL ATTENUATION	
		in	mm		in	mm	pF/ft	pF/m			MHz	dB/100'
C5761† RG 6/U Type UL CL2, CM c(UL) CM, (UL) 	18 Ga. Solid Bare Copper 6.5 Ω/Mft.	Foam PE		100% Flexfoil® +95% Bare Copper Braid 2.6 Ω/Mft.	PVC		16.20	53.15	83	75	1	0.26
		0.180	4.57		0.275	6.98					10	0.81
C5775 RG 6/U Type UL CL2, CATV, CM c(UL) CM, (UL) 	18 Ga. Solid Copper- Clad Steel 28.9 Ω/ Mft.	Foam PE		100% Flexfoil® Bonded +60% Aluminum Braid 9.0 Ω/Mft.	PVC		16.20	53.15	83	75	1	0.26
		0.180	4.57		0.276	7.01					10	0.81
C5886 RG 6/U Type Riser UL CL2R, CATVR, CMR c(UL) CMR, c(UL) CM (UL) 	18 Ga. Solid Copper- Clad Steel 28.9 Ω/ Mft.	Foam PE		100% Flexfoil® Bonded +60% Aluminum Braid 9.0 Ω/Mft.	PVC		16.20	53.15	83	75	1	0.34
		0.180	4.57		0.276	7.01					10	1.05

Data subject to change.

RG 6/U Type

Product Construction:

Conductors:

- Copper-clad steel per ASTM B869

Insulation/Core:

- Foam polyethylene (PE)

Shield:

- Tinned, bare copper or aluminum braid
- Flexfoil® shield

Jacket:





- Premium PVC compound or PE compound

Packaging:

- Please contact Customer Service for packaging and color options

Applications:

- CATV
- Direct burial

CATALOG NUMBER	AWG SIZE NOM. DCR	INSULATION O.D.		SHIELD COVERAGE NOM SHLD DCR	NOMINAL O.D.		NOMINAL CAPACITANCE		VELOCITY OF PROPAGATION, %	NOMINAL IMPEDANCE, Ω	NOMINAL ATTENUATION	
		in	mm		in	mm	pF/ft	pF/m			MHz	dB/100'
C5785 RG 6/U Type Quad-Shield UL CL2, CATV, CM c(UL) CM 	18 Ga. Solid Copper-Clad Steel 28.9 Ω/Mft.	Foam PE		(2) 100% Flexfoil® 1st Bonded (1) 60% (2) 40% Aluminum Braids 3.7 Ω/Mft.	PVC		16.20	53.15	83	75	1	0.35
		0.180	4.57		0.298	7.57					10	0.65
C5889 RG 6/U Type Riser Quad-Shield UL CL2R, CATVR, CMR c(UL) CM 	18 Ga. Solid Copper-Clad Steel 28.9 Ω/Mft.	Foam PE		(2) 100% Flexfoil® 1st Bonded (1) 60% (2) 40% Aluminum Braids 3.7 Ω/Mft.	PVC		16.20	53.15	83	75	1	0.26
		0.180	4.57		0.298	7.57					10	0.81
C5777 RG 6/U Type UL CL2, CATV, CM c(UL) CM 	18 Ga. Solid Copper-Clad Steel 28.9 Ω/Mft.	Foam PE		100% Flexfoil® Bonded +61% Tinned Copper Braid 6.5 Ω/Mft.	PVC		16.20	53.15	83	75	1	0.26
		0.180	4.57		0.271	6.88					10	0.81
C5804 RG 6/U Type MoistureGuard™ Direct Burial, Flooded 	18 Ga. Solid Copper-Clad Steel 28.9 Ω/Mft.	Foam PE		100% Flexfoil® Bonded +60% Aluminum Braid w/water block 9.0 Ω/Mft.	Black PE		16.20	53.15	83	75	1	0.26
		0.180	4.57		0.270	6.86					10	0.81

Data subject to change.



RG 6/U Type

Product Construction:

Conductors:

- Copper per ASTM B3
- Copper-clad steel per ASTM B869

Insulation/Core:

- Foam polyethylene (PE)

Shield:

- Aluminum braid
- Flexfoil® shield

Jacket:

- Premium PVC compound

Packaging:

- Please contact Customer Service for packaging and color options

Applications:

- LAN cable
- CATV
- Direct broadcast satellite

CATALOG NUMBER	AWG SIZE NOM. DCR	INSULATION O.D.		SHIELD COVERAGE NOM SHLD DCR	NOMINAL O.D.		NOMINAL CAPACITANCE		VELOCITY OF PROPAGATION, %	NOMINAL IMPEDANCE, Ω	NOMINAL ATTENUATION	
		in	mm		in	mm	pF/ft	pF/m			MHz	dB/100'
C5822 RG 6/U Dual-Type DBS UL CL2, CATV, CM c(UL) CM 	18 Ga. Solid Copper-Clad Steel 28.9 Ω/Mft.	Foam PE		100% Flexfoil® Bonded +60% Aluminum Braid 9.0 Ω/Mft.	PVC		16.20	53.15	83	75	1	0.26
		0.180	4.57		10	0.81						
					50	1.46						
		0.270 x 0.595	6.86 x 15.11		100	2.05						
					200	2.83						
					500	4.53						
					1000	6.59						
					1450	8.10						
					1800	8.80						
					2200	10.10						
3000	11.79											

Data subject to change.

RG 6/U Type

Product Construction:

Conductors:

- Copper per ASTM B3 or copper-clad steel per ASTM B869
- Twisted pair color code: black and red

Insulation/Core:

- Foam polyethylene (PE)
- Foam fluoropolymer (FEP)

Shield:

- Bare copper, tinned copper, or aluminum braid
- Flexfoil® shield

Jacket:





- Premium-grade PVC compound
- Flexguard® PVC compound

Packaging:

- Please contact Customer Service for packaging and color options

Applications:

- Suitable for RF signal transmission
- CATV
- CCTV†
- DBS
- Drop cable
- FM broadcast
- HDTV
- Digital video

CATALOG NUMBER	AWG SIZE NOM. DCR	INSULATION O.D.		SHIELD COVERAGE NOM SHLD DCR	NOMINAL O.D.		NOMINAL CAPACITANCE		VELOCITY OF PROPAGATION, %	NOMINAL IMPEDANCE, Ω	NOMINAL ATTENUATION	
		in	mm		in	mm	pF/ft	pF/m			MHz	dB/100'
C3521 RG 6/U Type Plenum UL CL2P, CMP c(UL) CMP 	18 Ga. Solid Bare Copper 6.5 Ω/Mft.	Fluoropolymer		Flexfoil® Bonded +95% Tinned Copper Braid 2.3 Ω/Mft.	Flexguard® PVC		16.00	52.50	83	75	1	0.30
		0.170	4.32		0.227	5.77					10	0.66
C3524 RG 6/U Type Plenum UL CL2P, CMP c(UL) CMP, CATV 	18 Ga. Solid Copper-Clad Steel 28.6 Ω/Mft.	Fluoropolymer		Flexfoil® Bonded +80% Aluminum Braid 9.0 Ω/Mft.	Flexguard® PVC		16.00	52.50	83	75	1	0.30
		0.170	4.32		0.232	5.89					10	0.66
C3525 RG 6/U Type Quad Shield Plenum UL CL2P, CMP c(UL) CMP 	18 Ga. Solid Copper-Clad Steel 28.6 Ω/Mft.	Fluoropolymer		(2) 100% Flexfoil® (1) 60% (2) 40% Aluminum Braids 5.3 Ω/Mft.	Flexguard® PVC		16.20	52.50	83	75	1	0.30
		0.170	4.32		0.264	6.70					10	0.66
C8029† RG 6/U Type +18 AWG Unshielded Pair UL CL2, CM c(UL) CM 	18 Ga. Solid Bare Copper Coax 18 AWG (7/26) Unshielded Pair	Foam PE		100% Flexfoil® 95% Bare Copper Braid 1.9 Ω/Mft. Unshielded Pair	PVC		17.00	53.15	83	75	1	0.26
		0.180	4.57		0.275	6.99					10	0.81
		Premium PVC			0.496	12.59					50	1.46
		0.010	0.25								100	2.05
200	2.83	500	4.53	1000	6.59							

Data subject to change.



RG 6/U Type

Product Construction:

Conductors:

- Copper per ASTM B3

Insulation/Core:

- Foam polyethylene (PE)
- Foam fluoropolymer (FEP)

Shield:

- Tinned copper braid
- Flexfoil® shield
- Bare copper braid

Jacket:



- Premium-grade PVC compound
- Flexguard® PVC compound or PVDF

Packaging:

- Please contact Customer Service for packaging and color options

Applications:

- Broadcast grade headend
- Serial Digital Interface (SDI)
- CATV
- DBS
- Drop cable
- HDTV
- CCTV†
- Digital video

CATALOG NUMBER	AWG SIZE NOM. DCR	INSULATION O.D.		SHIELD COVERAGE NOM SHLD DCR	NOMINAL O.D.		NOMINAL CAPACITANCE		VELOCITY OF PROPAGATION, %	NOMINAL IMPEDANCE, Ω	NOMINAL ATTENUATION	
		in	mm		in	mm	pF/ft	pF/m			MHz	dB/100'
395011 ETL CMR c(ETL) CMR ETL CL2R c(ETL) CL2R 	18 Ga. Solid Bare Copper 6.5 Ω/Mft.	Foam PE		Dual Foil + 95% Tinned Copper Braid Shield 2.8 Ω/Mft.	Flame-Retardant PVC		16.00	53.10	83	75	1	0.24
		0.180	4.57		0.275	6.91					3.6	0.45
495035† UL CMP c(UL) CMP 75°C 	18 Ga. Solid Bare Copper 6.7 Ω/Mft.	Fluoropolymer		95% Bare Copper Braid 2.0 Ω/Mft.	Flexguard® PVC		16.00	52.50	83	75	1	0.21
		0.170	4.32		0.277	5.77					10	0.59
											50	1.38
											100	2.24
											200	3.13
											540	5.50
											1000	8.16
											1500	10.12
											2250	13.23
											3000	16.11

Data subject to change.

RG 8/U Type

Product Construction:

Conductors:

- Copper per ASTM B3

Insulation/Core:

- Solid and foam polyethylene

Shield:

- Tinned or bare copper braid
- Flexfoil® shield

Jacket:



- Premium PVC compound

Packaging:

- Please contact Customer Service for packaging and color options

Applications:

- Suitable for RF signal transmission
- Broadcast

CATALOG NUMBER	AWG SIZE NOM. DCR	INSULATION O.D.		SHIELD COVERAGE NOM SHLD DCR	NOMINAL O.D.		NOMINAL CAPACITANCE		VELOCITY OF PROPAGATION, %	NOMINAL IMPEDANCE, Ω	NOMINAL ATTENUATION	
		in	mm		in	mm	pF/ft	pF/m			MHz	dB/100'
C1154 RG 8/U Type JAN-C-17A TYPE 	13 Ga. (7/21) Bare Copper 1.9 Ω/ Mft.	Solid PE		95% Bare Copper Braid 1.2 Ω/Mft.	PVC		30.80 101.05	66	50	1 10 50 100 200 500 1000	0.20 0.58 1.38 2.15 3.08 5.45 8.60	
		0.285	7.24		0.405	10.29						
C1198 RG 8/U Type 	11 Ga. (19/24) Bare Copper 1.9 Ω/ Mft.	Foam PE		95% Bare Copper Braid 1.1 Ω/Mft.	PVC		24.00 78.74	78	52	1 10 50 100 200 500 1000	0.30 0.75 1.30 1.80 3.00 4.50 6.00	
		0.285	7.24		0.405	10.29						
C1180 RG 8/U Type Air Core 	9½ Ga. Solid Bare Copper 0.90 Ω/ Mft.	Foam PE		100% Flexfoil® Bonded +88% Tinned Copper Braid 1.8 Ω/Mft.	PVC		24.60 80.71	84	50	1 10 50 100 200 500 1000	0.13 0.40 0.90 1.30 1.80 3.00 4.50	
		0.285	7.24		0.405	10.29						

Data subject to change.

RG 11/U Type

Product Construction:

Conductors:

- Copper-clad steel per ASTM B869

Insulation/Core:

- Foam polyethylene (PE)

Shield:

- Tinned, copper braid
- Flexfoil® shield

Jacket:

- Premium PVC compound

Packaging:

- Please contact Customer Service for packaging and color options

Applications:

- Suitable for RF signal transmission
- Broadcast digital video
- MATV
- CATV
- Drop cable
- Outdoor use

CATALOG NUMBER	AWG SIZE NOM. DCR	INSULATION O.D.		SHIELD COVERAGE NOM SHLD DCR	NOMINAL O.D.		NOMINAL CAPACITANCE		VELOCITY OF PROPAGATION, %	NOMINAL IMPEDANCE, Ω	NOMINAL ATTENUATION												
		in	mm		in	mm	pF/ft	pF/m			MHz	dB/100'											
C5029 RG 11/U Type UL CL2, CM c(UL) CM, CATV 	14 Ga. Solid Copper-Clad Steel 11.4 Ω/Mft.	Foam PE		100% Flexfoil® Bonded +61% Tinned Copper Braid 3.0 Ω/Mft.	PVC		16.20	53.15	83	75	1	0.30											
		0.280	7.11		0.400	10.16					10	0.70	50	0.90	100	1.30	200	1.90	500	3.00	1000	4.40	1450

Data subject to change.

RG 11/U Type

Product Construction:

Conductor:

- Copper-clad steel per ASTM B3

Insulation/Core:

- Foam polyethylene (PE)

Shield:

- Aluminum braid
- Flexfoil® shield

Jacket:

- Premium PVC compound

Packaging:

- Please contact Customer Service for packaging and color options

Applications:

- Suitable for RF signal transmission
- Broadcast digital video
- MATV
- CATV
- Drop cable

CATALOG NUMBER	AWG SIZE NOM. DCR	INSULATION O.D.		SHIELD COVERAGE NOM SHLD DCR	NOMINAL O.D.		NOMINAL CAPACITANCE		VELOCITY OF PROPAGATION, %	NOMINAL IMPEDANCE, Ω	NOMINAL ATTENUATION	
		in	mm		in	mm	pF/ft	pF/m			MHz	dB/100'
C5039 RG 11/U Type UL CL2, CATV, CM CSA CMG, c(UL) CM 	14 Ga. Solid Copper- Clad Steel 11.4 Ω/Mft.	Foam PE		100% Flexfoil® Bonded +60% Aluminum Braid 4.6 Ω/Mft.	PVC		16.20	53.15	85	75	1	0.30
		0.280	7.11		0.400	10.16					10	0.70
											50	0.90
											100	1.30
											200	1.90
											500	3.00
											1000	4.40
											1450	5.30
											1800	5.90
											2200	6.53
				3000	7.62							

Data subject to change.

RG 11/U Type Serial Digital Interface (SDI) Precision Cable

Extended-Distance, 75 Ohm High-End Coaxial Cables for Exacting Video, Analog & Digital Applications

Product Construction:

Conductor:

- Copper per ASTM B3

Insulation/Core:

- Foam polyethylene (PE)

Shield:

- Bare copper

Jacket:

- Premium PVC compound

Packaging:

- Please contact Customer Service for packaging and color options

Applications:

- Suitable for RF signal transmission
- Broadcast-grade Serial Digital Interface (SDI)
- Analog/digital video
- MATV
- CATV
- CCTV†
- Drop cable
- HDTV

CATALOG NUMBER	AWG SIZE NOM. DCR	O.D.		SHIELD COVERAGE NOM SHLD DCR	NOMINAL O.D.		NOMINAL CAPACITANCE		VELOCITY OF PROPAGATION, %	NOMINAL IMPEDANCE, Ω	NOMINAL ATTENUATION										
		in	mm		in	mm	pF/ft	pF/m			MHz	dB/100'									
395058† RG 11/U Type UL CM, CL2 c(UL) CMG 	14 Ga. Solid Bare Copper 2.6 Ω/Mft.	Foam PE		95% Bare Copper Braid 1.2 Ω/Mft.	Flame-Retardant PVC		16.20	52.50	83	75	1	0.17									
		0.280	7.11		0.400	10.16					10	0.35	50	0.90	100	1.30	200	1.90	400	2.90	540

Data subject to change.

RG 58/U Type

Product Construction:

Conductors:

- Copper per ASTM B3
- Tinned copper per ASTM B33

Insulation/Core:

- Solid and foam polyethylene (PE)
- Foam fluoropolymer (FEP)

Shield:

- Tinned copper braid

Jacket:





- Premium PVC compound

Packaging:

- Please contact Customer Service for packaging and color options

Applications:

- Suitable for RF signal transmission
- Broadcast
- LAN & data transmission

CATALOG NUMBER	AWG SIZE NOM. DCR	INSULATION O.D.		SHIELD COVERAGE NOM SHLD DCR	NOMINAL O.D.		NOMINAL CAPACITANCE		VELOCITY OF PROPAGATION, %	NOMINAL IMPEDANCE, Ω	NOMINAL ATTENUATION	
		in	mm		in	mm	pF/ft	pF/m			MHz	dB/100'
C1155 RG 58 C/U Type MIL-C-17C Type 	20 Ga. (19/0071) Tinned Copper 10.8 Ω/Mft.	Solid PE		95% Tinned Copper Braid 4.3 Ω/Mft.	Non- Contaminating PVC		30.80	101.05	66	50	1	0.42
		0.116	2.95		0.195	4.95					10	1.50
C1166 RG 58/U Type JAN-C-17A Type Ⓢ 1354 	20 Ga. Solid Bare Copper 10.1 Ω/Mft.	Solid PE		95% Tinned Copper Braid 4.3 Ω/Mft.	PVC		30.00	98.43	66	50	1	0.40
		0.116	2.95		0.195	4.95					10	1.20
C1188 RG 58 A/U Type UL CL2, CM CSA CMG Ⓢ 1354 	20 Ga. (19/32) Tinned Copper 9.5 Ω/Mft.	Foam PE		95% Tinned Copper Braid 4.3 Ω/Mft.	PVC		26.00	85.31	78	50	1	0.45
		0.114	2.90		0.195	4.95					10	1.42
C3519 RG 58/U Type Plenum UL CL2P, CMP c(UL) CMP 	19 Ga. Solid Bare Copper 8.1 Ω/Mft.	Fluoropolymer		95% Tinned Copper Braid 5.5 Ω/Mft.	Flexguard® PVC		25.00	82.00	80	53	1	0.40
		0.102	2.59		0.157	3.99					10	1.30
C1178A RG 58A/U Type JAN-C-17A Type Ⓢ 1354 	20 Ga. (19/0071) Tinner Copper 10.8 Ω/Mft	Solid PE		95% Tinned Copper Braid 4.3 Ω/Mft.	Black PVC		30.00	98.43	66	50	1	0.42
		0.116	2.95		0.195	4.95					10	1.50

Data subject to change.



RG 59/U Type

Product Construction:

Conductors:

- Copper per ASTM B3
- Copper-clad steel per ASTM B869
- Twisted pair color code: black and red

Insulation/Core:

- Solid and cellular polyethylene (PE)

Shield:

- Bare copper braid

Jacket:





- Premium PVC compound or PE compound

Packaging:

- Please contact Customer Service for packaging and color options

Applications:

- Suitable for RF signal transmission
- CATV
- MATV
- CCTV†
- Local Area Network
- Digital video
- Monitor/VDT display

CATALOG NUMBER	AWG SIZE NOM. DCR	INSULATION O.D.		SHIELD COVERAGE NOM SHLD DCR	NOMINAL O.D.		NOMINAL CAPACITANCE		VELOCITY OF PROPAGATION, %	NOMINAL IMPEDANCE, Ω	NOMINAL ATTENUATION	
		in	mm		in	mm	pF/ft	pF/m			MHz	dB/100'
C1102 RG 59/U Type 	20 Ga. Solid Copper- Clad Steel 45.9 Ω/Mft.	Foam PE		95% Bare Copper Braid 3.5 Ω/Mft.	Black PE		17.30	56.76	82	75	1	0.26
		0.146	3.71		0.242	6.15					10	0.82
C1104 RG 59/U Type 1354 	22 Ga. Solid Copper- Clad Steel 73.4 Ω/Mft.	Solid PE		95% Bare Copper Braid 2.6 Ω/Mft.	PVC		20.50	67.26	66	73	1	0.41
		0.146	3.71		0.242	6.15					10	0.99
C1103† RG 59/U Type UL CL2, CATV, CM CSA CMG 1354 	22 Ga. (7/30) Bare Copper 14.8 Ω/Mft.	Foam PE		95% Bare Copper Braid 2.6 Ω/Mft.	PVC		16.20	53.15	78	77	1	0.26
		0.146	3.71		0.242	6.15					10	0.91
C1142† RG 59/U Type UL CL2, CATV, CM CSA CMG 1354 	20 Ga. Solid Bare Copper 10.1 Ω/Mft.	Foam PE		95% Bare Copper Braid 2.6 Ω/Mft.	PVC		16.20	53.15	83	75	1	0.25
		0.146	3.71		0.236	5.99					10	0.78

Data subject to change.

RG 59/U Type

Product Construction:

Conductors:

- Copper per ASTM B3
- Copper-clad steel per ASTM B869
- Twisted pair color code: black and red

Insulation/Core:

- Solid polyethylene (PE), Fluoropolymer (FEP) and polyvinylchloride (PVC)

Shield:

- Tinned, bare copper or aluminum braid
- Flexfoil® shield

Jacket:



- Premium PVC compound

Packaging:

- Please contact Customer Service for packaging and color options

Applications:

- Suitable for RF signal transmission
- MATV
- CATV
- CCTV†
- Local Area Network
- Monitor/VDT display
- Analog video
- Digital video

CATALOG NUMBER	AWG SIZE NOM. DCR	INSULATION O.D.		SHIELD COVERAGE NOM SHLD DCR	NOMINAL O.D.		NOMINAL CAPACITANCE		VELOCITY OF PROPAGATION, %	NOMINAL IMPEDANCE, Ω	NOMINAL ATTENUATION	
		in	mm		in	mm	pF/ft	pF/m			MHz	dB/100'
C1106 RG 59B/U Type MIL-C-17D Type 	23 Ga. Solid Copper-Clad Steel 68.5 Ω/Mft.	Solid PE		95% Bare Copper Braid 2.6 Ω/Mft.	Non-Contaminating PVC		20.50	67.26	66	75	1 0.44 10 1.02 50 2.44 100 3.55 200 5.18 500 8.59 1000 13.56 1450 16.33 1800 18.19 2200 20.11 3000 23.49	
		0.146	3.71		0.240	6.10						
C8030† RG 59/U Type +18 AWG Unshielded Pair UL CMP c(UL) CMP 	20 AWG Solid BC Coax 18 AWG (7/26) Unshielded Pair	FEP		95% Bare Copper Braid	Flexguard® PVC		16.30	53.48	83	75	1 0.78 10 1.90 50 1.98 100 2.80 200 4.10 500 6.82 1000 9.64	
		0.135	3.43		0.200 X	5.08 X						
		PVC		Unshielded Pair	0.383	9.73						
		0.006	0.15									

Data subject to change.



RG 59/U Type

Product Construction:

Conductors:

- Copper-clad steel per ASTM B869

Insulation/Core:

- Foam polyethylene (PE)

Shield:

- Aluminum braid
- Flexfoil® shield

Jacket:



- Premium PVC compound

Packaging:

- Please contact Customer Service for packaging and color options

Applications:

- Suitable for RF signal transmission
- CATV
- MATV
- Drop cable
- Local Area Network
- Monitor/VDT display

CATALOG NUMBER	AWG SIZE NOM. DCR	INSULATION O.D.		SHIELD COVERAGE NOM SHLD DCR	NOMINAL O.D.		NOMINAL CAPACITANCE		VELOCITY OF PROPAGATION, %	NOMINAL IMPEDANCE, Ω	NOMINAL ATTENUATION	
		in	mm		in	mm	pF/ft	pF/m			MHz	dB/100'
C5770 RG 59/U Type UL CL2, CM CSA CMG 1354 	22 Ga. Solid Copper-Clad Steel 73.4 Ω/Mft.	Foam PE		100% Flexfoil® Bonded + 40% Aluminum Braid 11.0 Ω/Mft.	PVC		16.00	52.50	78	80	1	0.50
		0.144	3.66		0.236	5.99					10	1.00
C5780 RG 59/U Type MATV UL CL2, CM CSA CMG 1354 	20 Ga. Solid Copper-Clad Steel 45.9 Ω/Mft.	Foam PE		100% Flexfoil® Bonded + 40% Aluminum Braid 11.0 Ω/Mft.	PVC		16.20	53.15	83	75	1	0.60
		0.144	3.66		0.236	5.99					10	1.20
											50	2.30
											100	3.30
											200	4.10
											500	6.50
											1000	9.40
											1450	11.32
											1800	12.61
											2200	13.94
											3000	16.28

Data subject to change.

RG 59/U Type

Product Construction:

Conductors:

- Copper per ASTM B3
- Twisted pair color code: black and red

Insulation/Core:

- Foam polyethylene (PE), Fluoropolymer (FEP) and polyvinylchloride (PVC)

Shield:

- Bare copper braid
- Flexfoil® shield

Jacket:



- Premium PVC compound

Packaging:

- Please contact Customer Service for packaging and color options

Applications:

- Suitable for RF signal transmission
- MATV
- CCTV†
- Local Area Network
- Monitor/VDT display

CATALOG NUMBER	AWG SIZE NOM. DCR	INSULATION O.D.		SHIELD COVERAGE NOM SHLD DCR	NOMINAL O.D.		NOMINAL CAPACITANCE		VELOCITY OF PROPAGATION, %	NOMINAL IMPEDANCE, Ω	NOMINAL ATTENUATION	
		in	mm		in	mm	pF/ft	pF/m			MHz	dB/100'
C8027† RG 59/U Type +18 AWG Shielded Pair UL CL2, CM c(UL) CM 	22 AWG (7/30) Bare Copper Coax 18 AWG (16/30) Shielded Pair	Foam PE		95% Bare Copper Braid 125% Flexfoil® Al/PP Shielded	PVC		17.00	55.78	78	77	1	0.26
		0.144	3.66		0.242	6.15					10	0.91
		Premium PVC			X	X					50	2.09
		0.046	1.17		0.470	11.94					100	3.00
C8028† RG 59/U Type +18 AWG Unshielded Pair UL CL2, CM c(UL) CM 	20 AWG Solid Bare Copper Coax 18 AWG (7/26) Unshielded Pair	Foam PE		95% Bare Copper Braid Unshielded Pair	PVC		16.20	53.15	78	75	1	0.25
		0.144	3.66		0.238	6.05					10	0.78
		Premium PVC			X	X					50	1.97
		0.066	1.68		0.440	11.18					100	2.70
											500	6.35
											1000	9.15

Data subject to change.



RG 59/U Serial Digital Interface Cable

75 Ohm High-End Coaxial Cables for Video, Analog & Digital Applications

Product Construction:

Conductors:

- Copper per ASTM B3

Insulation/Core:

- Foam fluoropolymer (FEP)

Shield:

- Bare copper braid

Jacket:

- Premium PVC compound

Packaging:

- Please contact Customer Service for packaging and color options

Applications:

- Suitable for RF signal transmission
- Broadcast-grade
- MATV
- CATV
- Precision video-analog/digital
- Serial digital interface cable (SDI)

CATALOG NUMBER	AWG SIZE NOM. DCR	INSULATION O.D.		SHIELD COVERAGE NOM SHLD DCR	NOMINAL O.D.		NOMINAL CAPACITANCE		VELOCITY OF PROPAGATION, %	NOMINAL IMPEDANCE, Ω	NOMINAL ATTENUATION		
		in	mm		in	mm	pF/ft	pF/m			MHz	dB/100'	
495028† RG 59/U Type UL CMP c(UL) CMP 	20 Ga. Solid Bare Copper 10.5 Ω/Mft.	Fluoropolymer		95% Bare Copper Braid Shield 2.7 Ω/Mft.	Flexguard® PVC		16.00	52.50	84	75	1	0.24	
		0.139	3.43		0.196	4.97					10	1.41	50

Data subject to change.

RG 62/U Type

Product Construction:

Conductors:

- Copper-clad steel per ASTM B869

Insulation/Core:

- Foam polyethylene (PE)

Shield:

- Bare copper braid

Jacket:

- Premium PVC compound

Packaging:

- Please contact Customer Service for packaging and color options

Applications:

- Suitable for RF signal transmission
- Computer/networks

CATALOG NUMBER	AWG SIZE NOM. DCR	INSULATION O.D.		SHIELD COVERAGE NOM SHLD DCR	NOMINAL O.D.		NOMINAL CAPACITANCE		VELOCITY OF PROPAGATION, %	NOMINAL IMPEDANCE, Ω	NOMINAL ATTENUATION	
		in	mm		in	mm	pF/ft	pF/m			MHz	dB/100'
C1164 RG 62/U Type Computer Cable JAN-C-17A Type UL CL2, CM CSA CMG 	22 Ga. Solid Copper-Clad Steel 73.4 Ω/Mft.	Foam PE		95% Bare Copper Braid 2.6 Ω/Mft.	PVC		13.60	44.62	84	93	1	0.38
		0.146	3.66		0.242	6.15					10	0.85
					50	1.90						
					100	2.70						
					200	3.80						
500	5.90											
1000	8.70											

Data subject to change.

RG 174/U Type

Product Construction:

Conductors:

- Copper-clad steel per ASTM B869

Insulation/Core:

- Solid polyethylene (PE)

Shield:

- Tinned copper braid

Jacket:

- Premium PVC compound

Packaging:

- Please contact Customer Service for packaging and color options

Applications:

- Suitable for RF signal transmission

CATALOG NUMBER	AWG SIZE NOM. DCR	INSULATION O.D.		SHIELD COVERAGE NOM SHLD DCR	NOMINAL O.D.		NOMINAL CAPACITANCE		VELOCITY OF PROPAGATION, %	NOMINAL IMPEDANCE, Ω	NOMINAL ATTENUATION	
		in	mm		in	mm	pF/ft	pF/m			MHz	dB/100'
C1156 RG 174/U Type 	26 Ga. (7/34) Copper-Clad Steel 97.0 Ω/Mft.	Solid PE		88% Tinned Copper Braid 10.3 Ω/Mft.	PVC		30.00 98.43	66	50	1		1.90
		0.059	1.50		0.103	2.62				10		3.30
										50		5.80
										100		8.40
										200		12.50
				500		21.21						
				1000		34.00						

Data subject to change.

RG 213/U Type

Product Construction:

Conductors:

- Copper per ASTM B3

Insulation/Core:

- Solid polyethylene (PE)

Shield:

- Bare copper braid

Jacket:

- Premium non-contaminating black PVC

Packaging:

- Please contact Customer Service for packaging and color options

Applications:

- Suitable for RF signal transmission

CATALOG NUMBER	AWG SIZE NOM. DCR	INSULATION MATERIAL		SHIELD COVERAGE NOM SHLD DCR	NOMINAL O.D.		NOMINAL CAPACITANCE		VELOCITY OF PROPAGATION, %	NOMINAL IMPEDANCE, Ω	NOMINAL ATTENUATION				
		in	mm		in	mm	pF/ft	pF/m			MHz	dB/100'			
C1176A RG 213/U Type MIL-C-17G Type 	13 Ga. (7/21) Bare Copper 1.7 Ω/Mft.	Solid PE		95% Bare Copper Braid 1.2 Ω/Mft.	PVC		30.80	101.05	66	50	1	0.18			
		0.285	7.24		0.405	10.29					10	0.62	50	1.50	100

Data subject to change.

Twinaxial Cables

Product Construction:

Conductors:

- Tinned copper per ASTM B33

Insulation/Core:

- Solid polyethylene (PE)

Shield:

- Tinned copper braid
- Flexfoil® shield

Jacket:

- Premium PVC compound

Packaging:

- Please contact Customer Service for packaging and color options

Applications:

- Programmable Logic Controllers (PLC)
- Data transmission
- Broadcast
- Computer

CATALOG NUMBER	AWG SIZE NOM. DCR	INSULATION MATERIAL		SHIELD COVERAGE NOM SHLD DCR	NOMINAL O.D.		NOMINAL CAPACITANCE		VELOCITY OF PROPAGATION, %	NOMINAL IMPEDANCE, Ω	NOMINAL ATTENUATION	
		in	mm		in	mm	pF/ft	pF/m			MHz	dB/100'
C8001 UL CL2, CM C(UL) CM 2464 60°C, 300V 	20 Ga. (7/28) Tinned Copper 9.5 Ω/Mft.	Solid PE Coded: Natural, Blue 0.080 2.03		100% Flexfoil® +57% Tinned Copper Braid 4.1 Ω/Mft.	Blue PVC		20.00	65.62	66	78	1	0.60
					0.250	6.35					10	2.10
											50	5.00
											100	7.50
											200	11.00
											400	16.00

Data subject to change.

Specialty Cable



Prysmian offers a variety of Gepco® and CAROL® Brand wire and cable for audio/video and direct burial applications. From field production cable to microphone, snake, guitar and speaker cable, Prysmian supports the increasingly demanding entertainment industry.

For extreme hard service, Prysmian’s rubber microphone cables offer the ultimate in performance and service life. The rubber designs are highly flexible and designed to lie flat on studio floors, as well as provide high impact and abrasion resistance.

For outdoor and cold weather applications, microphone cable jacketed with Carolprene® provides the ultimate protection against ozone, oil and ultraviolet radiation.

These technically sophisticated cables are required to contain

sources of interference and to protect against difficulties where they are unavoidable. In addition to providing the needed electrical characteristics, the cables are properly designed to handle demanding conditions, such as microphone hum, handling noise, crosstalk, electrostatic hum, SCR noise and common ground noise—either on stage, in a studio or at a remote venue.

For more information on these cables or for other special applications, please contact your Prysmian sales representative.

Section	Page
Multi-Conductor, Flexfoil® Shield	132
Speaker Wire	133
Command® Series Home Entertainment Speaker Cable	134
CAROL® Brand DMX Lighting Control Cables	135
Special Audio, Communication & Instrumentation	136-137
Microphone Cable, Multi-Conductor, Carolprene	138
Irrigation and Landscape Lighting Solutions Guide	139-140
Low Voltage Sprinkler Wire Multi-Conductor, Carolprene	141

Multi-Conductor, Flexfoil® Shield



CATALOG NUMBER	NO. OF COND.	AWG SIZE	COND. STRAND	NOM. INSULATION THICKNESS		NOM. JACKET THICKNESS		NOMINAL O.D.		NOM. CAP.*	
				in	mm	in	mm	in	mm	A	B
C1228A	2	24	19/36	0.008	0.20	0.022	0.56	0.135	3.43	27.0	48.5

*A – Capacitance between conductors

*B – Capacitance between one conductor and other conductors connected to shield

Data subject to change.

COLOR CODE CHART

NO. OF COND.	COLOR
1	Black
2	Red

COLOR CODE CHART

NO. OF COND.	COLOR
Shielded	
1	Black
2	Red
3	Green
4	Yellow
Unshielded	
1	Blue
2	White

Product Construction:

Conductor:

- 24 AWG fully annealed stranded tinned copper per ASTM B-33

Insulation:

- Premium-grade, color-coded polypropylene
- Color code: See chart below

Shield:

- Conductive tape applied over the core
- 100% Flexfoil® aluminum/polyester, 25% overlap, minimum, foil facing in
- Stranded tinned copper drain wire

Jacket:

- PVC, black
- Temperature range: -20°C to +75°C

Applications:

- Electronic circuits where RF shielding is required
- Radio Transmitters
- Sound Systems
- Recording Studios
- Suggested voltage rating: 300 volts

Features:

- Excellent shielding to reduce noise

Compliances:

- RoHS Compliant Directive 2015/863/EU (RoHS-3)

Packaging:

- Please contact Customer Service for packaging and color options

Speaker Wire

UL Listed or AWM Style 1007

Product Construction:

Conductor:

- 18 AWG tinned annealed stranded copper
- Stranded tinned copper per ASTM B33

Insulation:

- Premium-grade, color-coded PVC
- Temperature range: -30°C to +80°C
- Color code: See chart below

Applications:

- Audio systems
- Not for in-wall use

Compliances:

- UL Style 1007 (UL: 80°C, 300 V)
- AWM Style 1007
- RoHS Compliant Directive 2011/65/EU

Packaging:

- 1000' (305 m) reels



CATALOG NUMBER	NO. OF COND.	AWG SIZE	COND. STRAND	NOM. INSULATION THICKNESS		NOMINAL O.D.	
				in	mm	in	mm

AWM STYLE 1007 (80°C, 300 V)

C7102A	2	18	7/0152	0.020	0.51	0.172	4.37
---------------	---	----	--------	-------	------	-------	------

Data subject to change.

COLOR CODE CHART

ORDERING SUFFIX	STOCK COLOR
99	Black-White

Product Construction:

Conductor:

- 24 thru 12 AWG fully annealed one bare, one tin stranded copper per ASTM B174

Insulation/Jacket:

- Premium-grade PVC
- Color code: See chart below

Applications:

- Digital audio
- Hi-fi and stereo speaker wire
- Jukeboxes
- Not for in-wall use
- Home theater

Compliances:

- UL Wires Misc.
- RoHS Compliant Directive 2015/863/EU (RoHS-3)

Packaging:

- Please contact Customer Service for packaging and color options



CATALOG NUMBER	NUMBER OF COND.	AWG SIZE	COND. STRAND	NOM. INSULATION THICKNESS		NOMINAL O.D.	
				in	mm	in	mm

C1356	2	24	7/32	0.016	0.41	0.058x0.117	1.47x2.79
C1362	2	22	7/30	0.020	0.51	0.070x0.145	1.77x3.68
C1360	2	20	10/30	0.020	0.51	0.085x0.160	2.16x4.06
C1357	2	18	16/30	0.020	0.51	0.083x0.181	2.11x4.60
C1358	2	16	26/30	0.020	0.51	0.105x0.210	2.67x5.33
C1361	2	14	41/30	0.025	0.64	0.125x0.235	3.18x5.69
C1363	2	12	65/30	0.025	0.64	0.154x0.323	3.91x8.20

COLOR CODE CHART

ORDERING SUFFIX	COLORS
01	Black
02	White
08	Brown
10	Gray
90	Clear



Command® Series Home Entertainment Speaker Cable

NEC Type CL3, CSA, CMG, AWM I/II A/B

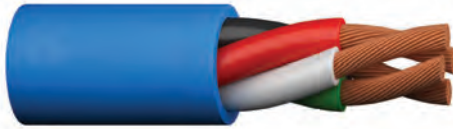

CATALOG NUMBER	NO. OF COND.	AWG SIZE	COND. STRAND	NOM. INSULATION WALL		NOM. JACKET THICKNESS		NOMINAL O.D.	
				in	mm	in	mm	in	mm
C1700t	2	12	65/30	0.009	0.15	0.021	0.53	0.254	6.45
C1701t	4	12	65/30	0.009	0.15	0.021	0.53	0.299	7.59
C1702t	2	14	41/30	0.009	0.15	0.021	0.53	0.220	5.59
C1703t	4	14	41/30	0.009	0.15	0.021	0.53	0.257	6.53
C1704	2	16	26/30	0.009	0.15	0.021	0.53	0.191	4.85
C1705	4	16	26/30	0.009	0.15	0.021	0.53	0.222	5.64

tCL3, CSA AWM I/II A/B only

COLOR CODE CHART

NO. OF COND.	COLOR
1	Black
2	Red
3	White
4	Green

Product Construction:

Conductor:

- 12, 14, 16, or 18 AWG fully annealed, stranded bare copper per ASTM B-8

Insulation:

- Premium-grade, color coded polypropylene
- Color code: see chart below

Jacket:

- PVC, command blue
- Temperature range: -20°C to +60°C

Applications:

- Digital audio
- Stereo Systems
- In-wall speakers
- Home theatre
- Remote control circuits
- Security Systems
- Bi-amp speakers

Features:

- Flexible

Compliances:

- NEC Article 725 Type CL3 (UL: 60°C)
- CSA, CMG, AWM, I/II A/B
- RoHS Compliant Directive 2015/863/EU (RoHS-3)
- Designed to meet UL 70,000 BTU Vertical Tray Flame Test
- Passes CSA FT-4 Vertical Flame Test

Packaging:

- Please contact Customer Service for packaging and color options

CAROL® Brand DMX Lighting Control Cables

Product Construction:

Conductor:

- 22 AWG fully stranded tinned copper per ASTM B33
- Twisted pairs

Insulation:

- Foam PE, .025" Wall
- Color code: See chart below

Shield:

- 100% foil braid, 90% tinned copper braid
- Stranded tinned copper drain wire

Jacket:

- Flexible, durable TPU, black
- Temperature range: -40°C to +75°C

Jacket Marking:

- 1 Pair: CAROL® PRODUCTS —122 —DMX LIGHTING CONTROL CABLE 1 PAIR 22 AWG STRANDED
- 2 Pair: CAROL® PRODUCTS —222 —DMX LIGHTING CONTROL CABLE 2 PAIR 22 AWG STRANDED

Applications:

- DMX512 Lighting Control
- For Portable Use or Remote Environments

Features:

- True DMX512 construction
- Low-capacitance data pairs
- Drain wire for easy shield termination
- Color-coded conductors for easy identification
- One- or Two-Pair designs available
- Durable, flexible, all-weather jacket.

Industry Approvals:

- Meets or exceeds USITT standards

Packaging:

- 1000' (304.8m)
- Other put-ups available on special order

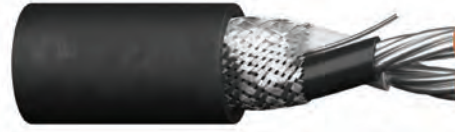

CATALOG NUMBER	NO. OF PAIRS	AWG SIZE	COND. STRAND	NOM. O.D. THICKNESS		NOMINAL O.D.		APPROX. NET WT. LBS/M	STD. CTN.
				in	mm	in	mm		
01220.41.01	1	22	7/30	0.245	6.22	0.245	6.22	33	1000'
02220.41.01	2	22	7/30	0.278	7.06	0.278	7.06	47	1000'

*Capacitance between one conductor and other conductors connected to shield
Data subject to change.

COLOR CODE CHART

NO. OF PAIRS	COLOR
1	Black, White
2	Black & White, Red & Blue

Special Audio, Communication & Instrumentation

UL 2095, 2093



CATALOG NUMBER	NO. OF COND.	AWG SIZE	COND. STRAND	NOM. INSULATION THICKNESS		NOM. JACKET THICKNESS		NOMINAL O.D.		NOM. CAP.*	
				in	mm	in	mm	in	mm	A	B
UL Style 2093, 300 VOLT											
C1333A	3	2-20 Shielded 1-20 Unshielded	7/28	0.016	0.41	0.028	0.71	0.206	5.23	26.0	47.0

*A – Capacitance between conductors
 *B – Capacitance between one conductor and other conductors connected to shield
 Data subject to change.

COLOR CODE CHART

NO. OF COND.	COLOR
Shielded	
1	Black
2	Red
Unshielded	
1	Natural



CATALOG NUMBER	NO. OF COND.	AWG SIZE	COND. STRAND	NOM. INSULATION THICKNESS		NOM. JACKET THICKNESS		NOMINAL O.D.		NOM. CAP.*	
				in	mm	in	mm	in	mm	A	B
UL Style 2095, 300 VOLT											
C1345A	6	4-24 Shielded 2-22 Unshielded	7/32 7/30	0.015	0.38	0.025	0.64	0.230	5.84	32.0	57.0

*A – Capacitance between conductors
 *B – Capacitance between one conductor and other conductors connected to shield
 Data subject to change.

COLOR CODE CHART

NO. OF COND.	COLOR
Shielded	
1	Black
2	Red
3	Green
4	Yellow
Unshielded	
1	Blue
2	White

Product Construction:

Conductor:

- 24 thru 20 AWG fully annealed stranded tinned copper per ASTM B33

Insulation:

- Premium-grade, color-coded polyethylene (C1333A) or PVC (C1345A)
- Color code: See chart below

Shield:

- 100% Flexfoil® aluminum/polyester foil with 25% overlap, minimum, foil facing out
- Stranded tinned copper drain wire

Jacket:

- PVC, gray
- Temperature range: -20°C to +80°C

Applications:

- Audio
- Communications
- EMI isolated circuits for instrumentation
- Suggested voltage rating: 300 volts

Compliances:

- UL Style 2093 (UL: 60°C, 300 V)
- UL Style 2095 (UL: 80°C, 300 V)
- RoHS Compliant Directive 2015/863/EU (RoHS-3)

Packaging:

- Please contact Customer Service for packaging and color options



Special Audio, Communication & Instrumentation

UL 2095, UL 2835, UL 2094, NEC Type CL2

Product Construction:

Conductor:

- 22 thru 18 AWG fully annealed stranded tinned copper per ASTM B33

Insulation:

- C1331A - Premium-grade, color-coded PVC
- C1340A - Premium-grade, color-coded polypropylene
- C1343A - Premium-grade, color-coded polyethylene
- Color code: See chart below

Shield:

- 100% Flexfoil® aluminum/polyester over two conductors, 25% overlap, minimum, foil facing out
- Stranded tinned copper drain wire

Jacket:

- PVC, gray
- Temperature range: -20°C to +105°C

Applications:

- Audio
- Communications
- EMI isolated circuits for instrumentation

Compliances:

- NEC Article 725 Type CL2 (UL: 75°C, 150 V)
- C1331A - UL Style 2095 (UL: 105°C)
- C1340A - UL Style 2835 (UL: 105°C)
- C1343A - UL Style 2094 (UL: 105°C)
- RoHS Compliant Directive 2015/863/EU (RoHS-3)

Packaging:

- Please contact Customer Service for packaging and color options



CATALOG NUMBER	NO. OF COND.	AWG SIZE	COND. STRAND	NOM. INSULATION THICKNESS		NOM. JACKET THICKNESS		NOMINAL O.D.		NOM. CAP.* pF/ft	
				in	mm	in	mm	in	mm	A	B

UL Style 2095, NEC Type CL2

C1331A	4	2-20 Shielded 2-20 Unshielded	7/28	0.016	0.41	0.032	0.81	0.230	5.84	41.0	74.0
---------------	---	----------------------------------	------	-------	------	-------	------	-------	------	------	------

UL Style 2835

C1340A	4	2-22 Shielded 2-22 Unshielded	7/30	0.008	0.20	0.017	0.43	0.161	4.09	29.0	52.0
---------------	---	----------------------------------	------	-------	------	-------	------	-------	------	------	------

UL Style 2094

C1343A	4	2-20 Shielded 2-18 Unshielded	7/28 16/30	0.018	0.46	0.032	0.81	0.259	6.58	27.0	49.0
---------------	---	----------------------------------	---------------	-------	------	-------	------	-------	------	------	------

*A – Capacitance between conductors

*B – Capacitance between one conductor and other conductors connected to shield
Data subject to change.

COLOR CODE CHART

NO. OF COND.	COLOR
Shielded	
1	Black
2	Red
Unshielded	
1	Green
2	White



Microphone Cable, Multi-Conductor, Carolprene®

High and Low Impedance



Product Construction:

Conductor:

- 18 and 16 AWG fully annealed stranded tinned copper per ASTM B33

Insulation:

- Premium-grade, color-coded rubber
- Color code: See chart below

Shield:

- 80% braid tinned copper

Jacket:

- Carolprene®, black
- Temperature range: -20°C to +60°C

Applications:

C1201:

- High-impedance microphones
- Broadcast and studio use
- Communication and audio systems
- Suggested voltage rating: 300 volts

C1202, C1602:

- Low-impedance microphones
- Studio use
- Control circuits
- Video and interconnecting cables
- Shielded power supplies
- Suggested voltage rating: 300 volts

Features:

- Precision engineered to transmit clear, noise-free signals
- Minimizes electrical “hum”
- Resistant to oil, acid, sunlight, abrasion and aging
- Excellent noise rejection

Compliances:

- RoHS Compliant Directive 2015/863/EU (RoHS-3)

Packaging:

- Please contact Customer Service for packaging and color options

CATALOG NUMBER	NO. OF COND.	AWG SIZE	COND. STRAND	NOM. INSULATION THICKNESS		NOM. JACKET THICKNESS		NOMINAL O.D.		NOM. CAP.* pF/ft
				in	mm	in	mm	in	mm	
C1201	1	18	41/34	0.040	1.02	0.035	0.89	0.240	6.10	46.0
C1202	2	18	41/34	0.020	0.51	0.035	0.89	0.295	7.49	61.0
C1602	2	16	65/34	0.025	0.64	0.035	0.89	0.335	8.51	55.0

*Capacitance between one conductor and other conductors connected to shield
Data subject to change.

COLOR CODE CHART

NO. OF COND.	COLOR
1	White
2	Black



Irrigation & Landscape Lighting

SOLUTIONS GUIDE

Underground Low-Voltage Sprinkler Wire 18 AWG Multi-Conductor PVC Insulated, PE Jacketed

Applications:

- For use in wiring irrigation control systems where cable must be suitable for direct burial
- Low-voltage golf course satellite sprinkler control
- Residential sprinkler solenoid control

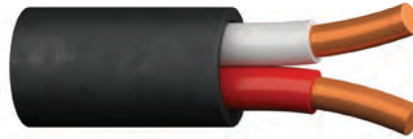

Standard Put-Ups:

- 250'
- 500'
- 1000'
- 2500'

Standard Color Code:

- Black jacket
- Refer to Color Code Chart on back for insulation

ISOTEC PART NUMBER	NO. OF COND.	NOM. INS. THICKNESS INCHES	JACKET THICKNESS INCHES	NOMINAL O.D. INCHES	WEIGHT PER MFT
182IRRAP	2	.016	.025	.183	21
183IRRAP	3	.016	.025	.216	29
184IRRAP	4	.016	.025	.236	37
185IRRAP	5	.016	.025	.250	45
186IRRAP	6	.016	.025	.266	52
187IRRAP	7	.016	.025	.280	59
188IRRAP	8	.016	.025	.300	67
1810IRRAP	10	.016	.025	.327	81
1812IRRAP	12	.016	.025	.355	96
1813IRRAP	13	.016	.025	.368	104

Communication & Control Cable 18 & 20 AWG Multi-Paired, PE Insulated

Applications:

- For use with golf course irrigation control systems

Standard Put-Ups:

- 500'
- 1000'

Standard Color Code:

- Black jacket
- Refer to Color Code Chart on back for insulation



ISOTEC PART NUMBER	NO. OF COND.	AWG/STRANDING	INSULATION THICKNESS & TYPE	JACKET THICKNESS & TYPE	NOMINAL O.D. INCHES
C6061A	Individually Shld. 3 PR w/20 AWG Stranded T.C. Drain	10/30 Tinned Copper	.013" Polypropylene	.047" Polyethylene	.340

Irrigation & Landscape Lighting

SOLUTIONS GUIDE

Underground Feeder (UF) Cable 600 V Single Conductor, PVC Insulated

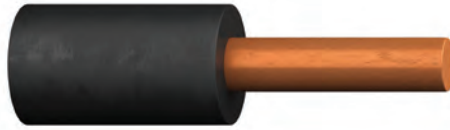

Applications:

- For use in irrigation as described in Article 339 of the National Electric Code (NEC)
- 18 AWG and 16 AWG are not permitted to be UL Listed as Type UF*

Standard Put-Ups:

- 500'
- 1000'
- 2500'

Standard Colors:

- Please consult customer service for information on available colors

ISOTEC PART NUMBER	AWG/STRANDING	INSULATION THICKNESS INCHES	NOMINAL O.D. INCHES	WEIGHT PER MFT
181UF*	18 (Solid)	0.045	0.134	13
161UF*	16 (Solid)	0.045	0.144	17
141UF	14 (Solid)	0.060	0.186	28
121UF	12 (Solid)	0.060	0.205	37
101UF	10 (Solid)	0.060	0.225	52

Note: PE UF cable is available upon special request. Please consult customer service.

Underground Low-Voltage Landscape Lighting Cable 150 V Flat Parallel, PVC Insulated



Applications:

- For use in wiring low-voltage outdoor landscape lighting and security lighting circuits where cable must be suitable for direct burial

Standard Put-Ups:

- 250'
- 500'
- 1000'

Standard Jacket Color:

- Black

ISOTEC PART NUMBER	AWG/STRANDING	NOM. INS. THICKNESS INCHES	NOMINAL O.D. INCHES	WEIGHT PER MFT
182ULC00	18 16/30 B/C	0.041	.209 X .145	26
162ULC00	16 26/30 B/C	0.041	.315 X .155	36
142ULC00	14 41/30 B/C	0.041	.350 X .170	46
122ULC00	12 65/30 B/C	0.041	.390 X .195	86
102ULC00	10 105/30 B/C	0.062	.470 X .240	122
802ULC00	8 133/0125 B/C	0.078	.630 X .316	199

Low-Voltage Sprinkler Wire

60°C 30 Volts UL



CATALOG NUMBER	NO. OF COND.	AWG SIZE	LENGTH OF CORD (FEET)	PACKAGE TYPE	POWER RATING ⁽¹⁾			PKG PER CTN.	APPROX. WEIGHT PER CTN (LBS) ⁽⁵⁾	CARTON DIMENSIONS (H x W x D)	UPC NUMBER
					VOLTS	AMPS	WATTS				
LOW VOLTAGE SPRINKLER WIRE - 30 VOLTS - UL											
23804.18.01	4	18	500	Spool	30	15	450	1	18	10.625 x 10.625 x 6.313	079407908047
23815.60.01	5	18	50	Cuff	30	15	450	6	13	8.5 x 12.25 x 14	079407238156
23825.60.01	5	18	100	Cuff	30	15	450	6	27	9.5 x 14 x 17	079407238255
23805.18.01	5	18	500	Spool	30	15	450	1	22	10.625 x 10.625 x 6.313	079407908054
23817.60.01	7	18	50	Cuff	30	15	450	6	18	8.5 x 12.25 x 14	079407238170
23827.60.01	7	18	100	Cuff	30	15	450	6	36	9.5 x 14 x 17	079407238279
23807.18.01	7	18	500	Spool	30	15	450	1	31	10.625 x 10.625 x 6.313	079407908078
23810.18.01	10	18	500	Reel	30	15	450	1	44	—	079407908108

(1) Amps and watts are offered ONLY as a guide to the end user.
 (5) Actual shipping weight may vary.
 Data subject to change.

Product Construction:

Conductor:

- 18 AWG fully annealed solid bare copper per ASTM B3

Insulation:

- Premium-grade, color-coded PVC
- Premium-grade PE jacket, black
- Nylon rip cord to facilitate jacket removal
- Temperature range: -20°C to +60°C
- Color code: See chart at left

Jacket Marking:

- CAROL (SIZE) 30 V SPRINKLER SYSTEMS WIRE
- DIRECT BURIAL E54567 (UL)

Applications:

- Low-voltage golf course satellite sprinkler control
- Residential sprinkler solenoid control

Compliances:

- UL Listed under a UL Miscellaneous Wire file
- UL Listed for outdoors applications
- UL Listed for direct burial applications

Packaging:

- See tabular data above
- Please contact Customer Service for packaging and color options

COLOR CODE CHART

NO. OF COND.	COLOR	NO. OF COND.	COLOR	NO. OF COND.	COLOR
1	Black	5	Orange	9	Gray
2	White	6	Yellow	10	Purple
3	Red	7	BLue		
4	Green	8	Brown		



Hook-Up Wire

10

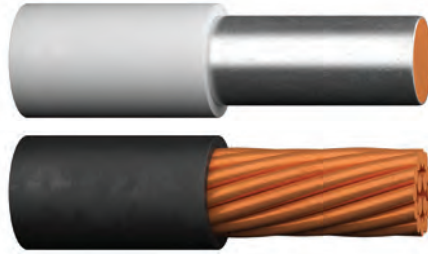

Most applications of hook-up and lead wire for board-to-board or point-to-point wiring rely on PVC-insulated designs.

Prysmian’s CAROL® Brand products offer both electrical and electronic designers a vast array of quality PVC hook-up wire to meet the specific technical demands of today, with “off-the-shelf” distributor inventoried products.

Hook-up wire is also available in special colors and/or stripe combinations with a minimum of lead time. In addition, Prysmian offers a variety of put-ups to meet individual customer requirements.

Section	Page
UL 1007, UL 1569, CSA TR-64	143
UL 1015, CSA TEW	144
UL Types MTW, TFF, AWM & CSA TEW	145
Heavy Wall UL Types MTW, AWM, NEC Type THW and CSA TEW	146
Rubber/PVC/Polyethylene	147

UL 1007, UL 1569, CSA TR-64

Product Construction:

Conductor:

- 24 thru 16 AWG
- Fully annealed tinned copper per ASTM B33
- Solid or stranded

Insulation:

- Premium-grade, color-coded PVC
- Temperature range: -20°C to +105°C
- Color code: See chart below

Applications:

- Internal wiring of electrical and electronic equipment
- Internal wiring of panels and meters
- Point-to-point wiring
- Suggested voltage rating: 300 volts

Compliances:

- UL Style 1007 (UL: 80°C, 300 V)
- CSA TR-64: 90°C, 300 V
- RoHS Compliant Directive 2015/863/EU (RoHS-3)
- Designed to meet UL VW-1 Vertical Wire Flame Test

Packaging:

- Please contact Customer Service for packaging and color options



CATALOG NUMBER	AWG SIZE	COND. STRAND	NOM. INSULATION THICKNESS		NOMINAL O.D.	
			in	mm	in	mm
SOLID CONDUCTORS						
C2003A	24	Solid	0.016	0.41	0.052	1.32
C2004A	22	Solid	0.016	0.41	0.057	1.45
C2028A	20	Solid	0.016	0.41	0.064	1.63
C2052A	18	Solid	0.016	0.41	0.072	1.83
C2053A	16	Solid	0.016	0.41	0.083	2.11
STRANDED CONDUCTORS						
C2015A	24	7/32	0.016	0.41	0.056	1.42
C2016A	22	7/30	0.016	0.41	0.062	1.57
C2040A	20	10/30	0.016	0.41	0.070	1.78
C2064A	18	16/30	0.016	0.41	0.080	2.03
C2065A	16	26/30	0.016	0.41	0.092	2.34

Data subject to change.

COLOR CODE CHART

ORDERING SUFFIX	COLOR	ORDERING SUFFIX	COLOR
01	Black	06	Green
02	White	07	Blue
03	Red	08	Brown
04	Orange	10	Gray
05	Yellow	19	Purple

Striped combinations available upon request; consult Customer Service.



UL 1015, CSA TEW



Product Construction:

Conductor:

- 24 thru 10 AWG
- Fully annealed tinned copper per ASTM B33
- Solid or stranded

Insulation:

- Premium-grade, color-coded PVC
- Temperature range: -30°C to +105°C
- Color code: See chart below

Applications:

- Internal wiring of electrical and electronic equipment
- Internal wiring of panels and meters
- Point-to-point wiring
- Suggested voltage rating: 600 volts

Compliances:

- UL Style 1015 (UL: 105°C, 600 V)
- CSA Type TEW: 105°C, 600 V
- RoHS Compliant Directive 2015/863/EU (RoHS-3)
- Designed to meet UL VW-1 Vertical Wire Flame Test

Packaging:

- Please contact Customer Service for packaging and color options

CATALOG NUMBER	AWG SIZE	COND. STRAND	NOM. INSULATION THICKNESS		NOMINAL O.D.	
			in	mm	in	mm

SOLID CONDUCTORS

C2117A	22	Solid	0.032	0.81	0.089	2.26
C2118A	20	Solid	0.032	0.81	0.096	2.44
C2119A	18	Solid	0.032	0.81	0.104	2.64

STRANDED CONDUCTORS

C2100A	24	7/32	0.032	0.81	0.088	2.24
C2101A	22	7/30	0.032	0.81	0.094	2.39
C2102A	20	10/30	0.032	0.81	0.102	2.59
C2103A	18	16/30	0.032	0.81	0.112	2.84
C2104A	16	26/30	0.032	0.81	0.124	3.15
C2105A	14	41/30	0.032	0.81	0.141	3.58
C2106A	12	65/30	0.032	0.81	0.160	4.06
C2107A	10	105/30	0.033	0.84	0.184	4.67

Data subject to change.

COLOR CODE CHART

ORDERING SUFFIX	COLOR	ORDERING SUFFIX	COLOR
01	Black	06	Green
02	White	07	Blue
03	Red	08	Brown
04	Orange	10	Gray
05	Yellow	19	Purple

Striped combinations available upon request; consult Customer Service.



UL Types MTW, TFF, AWM & CSA TEW

90°C 600 Volt MTW, TFF 105°C 600 Volt AWM/TEW

Product Construction:

Conductor:

- 18 through 8 AWG fully annealed stranded bare copper per ASTM B8

Insulation:

- Premium-grade, color-coded PVC
- Temperature range:
 - MTW: -40°C to +90°C
 - AWM: -40°C to +105°C
 - TEW: -30°C to +105°C
- Color code: See chart below

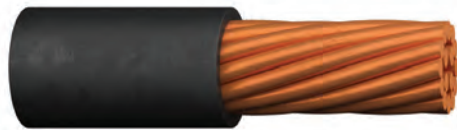

Jacket Marking:

- 18 and 16 AWG: CAROL (SIZE) 600 V E# MTW (UL) OR TFF OR 1000 V AWM VW-1 --- CSA TEW 105°C FT1 ROHS MADE IN USA
- 14 through 8 AWG: CAROL (SIZE) 600 V E# MTW (UL) OR 1000 V AWM VW-1 --- CSA TEW 105°C FT1 ROHS MADE IN USA

Applications:

- Motor and transformer lead
- External wiring of machinery
- Internal wiring of electrical and electronic equipment
- Internal wiring of panels and meters
- Point-to-point wiring

Features:

- Outstanding oil, flame and moisture resistance
- Extra flexible

Compliances:

- UL and NMTBA Type MTW/AWM
- CSA TEW
- RoHS Compliant Directive 2015/863/EU (RoHS-3)
- Passes VW-1 Vertical Flame Test
- AWM Style 1015 – 18-8 AWG
- AWM Style 1335 – 18-10 AWG
- AWM Style 1336 – 8 AWG
- UL 1032 1000 V

Packaging:

- Please contact Customer Service for packaging and color options

CATALOG NUMBER	AWG SIZE	COND. STRAND	NOM. INSULATION THICKNESS		NOMINAL O.D.		STOCK COLORS	APPROX. NET WEIGHT LBS/M ^(S)
			in	mm	in	mm		
UL TYPE MTW, AWM, TFF, CSA TYPE TEW-600 VOLT								
76502	18	16/30	0.032	0.81	0.110	2.79	1-12	10
76512	16	26/30	0.032	0.81	0.123	3.12	1-12	14
76812	14	19/0159	0.032	0.81	0.136	3.40	1-12	20
76822	12	19/0185	0.032	0.81	0.155	3.91	1-7	28
76832	10	19/0234	0.032	0.81	0.179	4.55	1-5	42
76843	8	19/0295	0.047	1.19	0.242	6.15	1-5	72

^(S) Actual shipping weight may vary. Data subject to change.

COLOR CODE CHART

ORDERING SUFFIX	COLOR	ORDERING SUFFIX	COLOR
01	Black	07	Blue
02	White	08	Brown
03	Red	10	Gray
04	Orange	13	Pink
06	Green	19	Purple



Heavy Wall UL Types MTW, AWM, NEC Type THW and CSA TEW

90°C 600 Volts

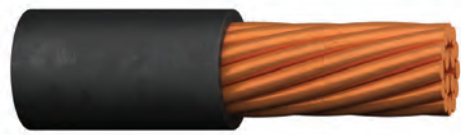

Product Construction:

Conductor:

- 6 and 4 AWG fully annealed stranded bare copper per ASTM B8

Insulation:

- Premium-grade, color-coded PVC, black
- Temperature range:
 MTW: -40°C to +90°C
 AWM: -40°C to +105°C
 TEW: -30°C to +105°C

Jacket Marking:

- CAROL (SIZE) 600 V E# MTW OR THW (UL) OR 1000 V AWM VW-1 --- CSA TEW 105°C FT1 ROHS MADE IN USA

Applications:

- Motor and transformer lead
- External wiring of machinery

Features:

- Outstanding oil, flame and moisture resistance
- Extra flexible

Compliances:

- UL Type AWM
- UL and NMTBA Type MTW
- NEC Type THW
- CSA TEW
- RoHS Compliant Directive 2015/863/EU (RoHS-3)
- Passes UL VW-1 Vertical Flame Test

Packaging:

- Please contact Customer Service for packaging and color options

CATALOG NUMBER	AWG SIZE	COND. STRAND	NOM. INSULATION THICKNESS		NOMINAL O.D.		APPROX. NET WEIGHT LBS/m ⁽⁵⁾
			in	mm	in	mm	
AWM, MTW, THW - 600 VOLT - UL							
76954	6	19/0372	0.064	1.63	0.315	8.00	110
76994	4	19/0469	0.065	1.65	0.365	9.27	150

⁽⁵⁾Actual shipping weight may vary.
Data subject to change.



Underwriters Laboratories Inc.



Rubber/PVC/Polyethylene

Product Construction:

Conductor:

- 20, 18 and 14 AWG fully annealed stranded tinned copper per ASTM B33

Insulation:

- Premium-grade, color-coded rubber, PVC or polyethylene
- Temperature range:
 - 40°C to +90°C rubber
 - 30°C to +105°C PVC
 - 60°C to +80°C polyethylene
- Color code: See chart below

Applications:

- Test equipment
- Oscilloscopes

Compliances:

- RoHS Compliant Directive 2015/863/EU (RoHS-3)

Packaging:

- Please contact Customer Service for packaging and color options

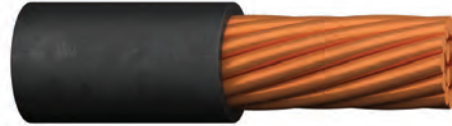

CATALOG NUMBER	NO. OF COND.	AWG SIZE	COND. STRAND	NOM. INSULATION THICKNESS		BREAKDOWN VOLTAGE (AC, rms)	WORKING VOLTAGE*	NOMINAL O.D.	
				in	mm			in	mm

RUBBER TEST LEAD

C1326	1	20	41/36	0.040	1.02	6,000V	1,500V	0.125	3.18
C1319	1	20	41/36	0.047	1.19	12,000V	3,000V	0.140	3.56
C1321	1	18	65/36	0.045	1.14	20,000V	5,000V	0.145	3.68
C1318	1	18	65/36	0.088	2.24	29,000V	10,000V	0.230	5.84

PVC TEST LEAD

C1320A	1	18	65/36	0.047	1.19	20,000V	5,000V	0.140	3.56
---------------	---	----	-------	-------	------	---------	--------	-------	------

POLYETHYLENE TEST LEAD

C7108A	1	14	105/34	0.032	0.81	4,000V	600V	0.140	3.56
---------------	---	----	--------	-------	------	--------	------	-------	------

*For intermittent duty only.
Data subject to change.

COLOR CODE CHART

ORDERING SUFFIX	COLOR
01	Black
03	Red
06	Green

Notes:

Technical Information

As technology becomes more complex, specifying wire and cable products to meet system performance demands becomes more time-consuming and complex.

Today's system designer must be aware not only of the general transmission line types, but also of the myriad of materials available to meet specific environmental or electrical performance criteria.

This technical section is presented to aid in the selection of materials and designs which will best suit the combination of hardware and transmission media.

For technical questions regarding specific transmission designs or applications, please contact Prysmian's Engineering Department.

Section	Page
Insulation & Jacket Properties	150
Decimal Conversion Factors	151
Unit Conversion Factors	152
Temperature Conversion Chart	153
Conduit Capacity Chart	154
AWG Conductor Chart	155
Glossary	156-166
Abbreviations & Acronyms	167-169
Hook-Up Wire Product Finder	170
Multi-Conductor Cable Product Finder	171-176
Belden to CAROL Brand Catalog Cross Reference Index	177-178
NEC/CEC Substitution Chart	179-180
Agency Symbols	181
Put-Ups and Color Codes	182

Insulation & Jacket Properties

TYPICAL PROPERTIES OF COMMON INSULATING MATERIALS

PARAMETER	PVC	PE	PP	XLPE	NYLON	FEP	TFE	BUTYL RUBBER	SILICONE RUBBER	TPR
Specific Gravity	1.37	0.92	0.89	0.93-1.18	1.09	2.16	2.17	1.40	1.24	1.16-1.20
Dielectric Constant (a) 60 Hz (b) 1000 Hz	6.0 5.0	2.26 2.26	2.6	3.0 3.0	4.6 4.5	2.15 2.15	2.1 2.1	4.1 4.0	3.3 3.1	2.8 2.8
Dielectric Strength, v/mil (a) 0.010" wall (b) 0.040" wall	1800 800	2100 1050	850 450	- 700	1000 470	2000 950	2000 950	700 500	600 400	625
Tensile Strength, PSI x 1000	1.5-3.8	1.4-2.4	2.9-4.5	1.8-2.5	8.8-11.9	2.3-3.1	2.0-6.0	0.5-1.5	0.6-1.2	2.3
Service Temp, Range, °C	-55/+105	-90/+90	-40/+105	-80/+75	-55/+105	-90/+200	-90/+260	-40/+90	-80/+200	-55/+90
Elongation, %	200-375	350-550	700	250-400	150-380	200-330	200-500	200-400	125-400	500
Water Absorption, % in 24 hr	<0.75	<0.02	<0.02	<0.01	2.5	<0.01	<0.01	<1.0	<1.0	<0.6
Flame Resistance	Self Extinguishing	Supports Flame	Supports Flame	Slow Flame	Self Extinguishing	Non-Flammable	Non-Flammable	Slow Burning	Slow (Non-Cond. Ash)	Flammable
Ozone Resistance	Excellent	Good	Excellent	Good	Good	Excellent	Excellent	Excellent	Excellent	Excellent
Flexibility	Good	Good	Good	Good-Fair	Good-Fair	Good	Good	Excellent	Excellent	Excellent
Abrasion Resistance	Good	Good	Fair	Excellent	Excellent	Excellent	Excellent	Poor	Poor	Good-Fair
Acid Resistance	Excellent	Excellent	Excellent	Excellent	Excellent	Poor	Excellent	Excellent	Good	Excellent
Base Resistance	Excellent	Excellent	Excellent	Excellent	Excellent	Excellent	Excellent	Good	Good	Excellent
Hydraulic Fluid Resistance	Good-Fair	Fair-Poor	Fair	Good-Fair	Good-Fair	Excellent	Excellent	Poor	Fair-Poor	Poor
Organic Solvent Resistance	Fair-Poor	Poor	Fair	Fair	Good-Fair	Excellent	Excellent	Good-Fair	Poor	Poor

NOTE: The above is representative of performance. For specific compound performance, consult Customer Service.

TYPICAL PROPERTIES OF COMMON JACKETING MATERIALS

PARAMETER	PVC	PE	NYLON	FEP	TFE	SILICONE RUBBER	NEOPRENE	POLY-URETHANE	TPR
Specific Gravity	1.37	0.92	1.09	2.16	2.17	1.24	1.52	1.3	1.16-1.20
Tensile Strength, PSI x 1000	1.5-3.8	1.4-2.4	8.8-11.9	2.3-3.1	2.0-6.0	0.6-1.2	2.5-4.0	>3.5	2.3
Elongation, %	200-375	350-550	150-380	200-330	200-500	125-400	300-500	540-700	500
Service Temp, Range, °C	-55/+105	-80/+75	-55/+105	-90/+200	-90/+200	-80/+200	-65/+90	-65/+75	-55/+90
Ozone Resistance	Excellent	Good	Good	Excellent	Excellent	Excellent	Excellent	Good	Excellent
Weatherability	Good-Fair	Excellent-Good	Fair-Poor	Excellent	Excellent	Excellent	Good	Good	Excellent
Flame Resistance	Self Extinguishing	Supports Flame	Flammable	Non-Flammable	Non-Flammable	Slow-Burn (Non-Cond. Ash)	Self Extinguishing	Slow Burn	Flammable
Flexibility	Good	Good	Good-Fair	Good	Good	Excellent	Excellent	Excellent	Excellent
Abrasion Resistance	Good	Good	Excellent	Excellent	Excellent	Poor	Excellent	Excellent	Good-Fair
Acid Resistance	Excellent	Excellent	Poor	Excellent	Excellent	Poor	Good	Fair	Excellent
Base Resistance	Excellent	Excellent	Excellent	Excellent	Excellent	Good	Good	Fair	Excellent
Hydraulic Fluid Resistance	Good-Fair	Fair-Poor	Good-Fair	Excellent	Excellent	Fair-Poor	Good	Poor	Good
Organic Solvent Resistance	Fair-Poor	Poor	Good-Fair	Excellent	Excellent	Poor	Good	Poor	Poor
Resistance to Tearing	Good	Good	Excellent	Good	Good	Fair	Good	Excellent	Good-Fair

NOTE: The above is representative of performance. For specific compound performance, consult Customer Service.



Decimal Conversion Factors

FRACTIONS, DECIMALS AND MILLIMETER CONVERSION CHART

FRACTIONS OF AN INCH						EQUIVALENTS		FRACTIONS OF AN INCH						EQUIVALENTS	
64	32	16	8	4	2	DECIMALS	mm	64	32	16	8	4	2	DECIMALS	mm
1						0.016	0.40	33						0.516	13.10
2	1					0.031	0.79	34	17					0.531	13.49
3						0.047	1.19	35						0.547	13.89
4	2	1				0.063	1.59	36	18	9				0.563	14.29
5						0.078	1.98	37						0.578	14.68
6	3					0.094	2.38	38	19					0.594	15.08
7						0.109	2.78	39						0.609	15.48
8	4	2	1			0.125	3.18	40	20	10	5			0.625	15.88
9						0.141	3.57	41						0.641	16.27
10	5					0.156	3.97	42	21					0.656	16.67
11						0.172	4.37	43						0.672	17.07
12	6	3				0.188	4.76	44	22	11				0.688	17.46
13						0.203	5.16	45						0.703	17.86
14	7					0.219	5.56	46	23					0.719	18.26
15						0.234	5.95	47						0.734	18.65
16	8	4	2	1		0.250	6.35	48	24	12	6	3		0.750	19.05
17						0.266	6.75	49						0.766	19.45
18	9					0.281	7.14	50	25					0.781	19.84
19						0.297	7.54	51						0.797	20.24
20	10	5				0.313	7.94	52	26	13				0.813	20.64
21						0.328	8.33	53						0.828	21.03
22	11					0.344	8.73	54	27					0.844	21.43
23						0.359	9.13	55						0.859	21.83
24	12	6	3			0.375	9.53	56	28	14	7			0.875	22.23
25						0.391	9.92	57						0.891	22.62
26	13					0.406	10.32	58	29					0.906	23.02
27						0.422	10.72	59						0.922	23.42
28	14	7				0.438	11.11	60	30	15				0.938	23.81
29						0.453	11.51	61						0.953	24.21
30	15					0.469	11.91	62	31					0.969	24.61
31						0.484	12.30	63						0.984	25.00
32	16	8	4	2	1	0.500	12.70	64	32	16	8	4	2	1.000	25.40

Unit Conversion Factors

CONVERSION FACTORS

UNIT	X	CONSTANT	=	UNIT	UNIT	X	CONSTANT	=	UNIT
British Thermal Unit (BTU)		778.0		foot-pound (ft-lb)	gallons (gal)		3.785411		liters (l)
British Thermal Unit (BTU)		1054.35		joules (j)	gallons (gal)		0.13368		cubic foot (ft ³)
British Thermal Unit (BTU)		0.293		watt-hours (w-hr)	gallons (gal)		231.0		cubic inch (in ³)
British Thermal Unit (BTU)		0.032808		feet (ft)	gallons (gal)		3785.411		cubic centimeter (cm ³)
British Thermal Unit (BTU)		0.3937		inches (in)	grams (g)		15.432		grains
centimeters (cm)		0.00001		kilometers (km)	gram/centimeter ³ (gm/cm ³)		0.0361275		pounds/in ³ (lb/in ³)
centimeters (cm)		0.010		meters (m)	horsepower (hp)		33013.26		ft-lb/min
centimeters (cm)		10.0		millimeters (mm)	horsepower (hp)		550.0		ft-lb/sec
centimeters (cm)		0.00064516		circular millimeters	horsepower (hp)		745.7		watts (w)
centimeters (cm)		0.0000007854		inches ² (in ²)	horsepower (hp)		0.027178		yards (yd)
centimeters (cm)		0.00050671		square millimeters	inch (in)		0.083333		feet (ft)
circular mils (cmil)		0.7854		(mm ²)	inch (in)		0.00002540		kilometer (km)
circular mils (cmil)		0.000035314		mils ²	inch (in)		0.025400		meter (m)
circular mils (cmil)		0.061023		cubic foot (ft ³)	inch (in)		2.54000514		centimeter (cm)
circular mils (cmil)		0.000001		cubic inch (in ³)	inch (in)		25.4000514		millimeter (mm)
cubic centimeter (cm ³)		0.00026417		cubic meter (m ³)	inch (in)		1000.0		mils
cubic centimeter (cm ³)		1728.0		gallons (gal)	inch (in)		0.000948		British Thermal Unit (BTU)
cubic centimeter (cm ³)		28317.847		cubic in (in ³)	joules (j)		10 ⁷		ergs
cubic centimeter (cm ³)		0.00057870		cubic centimeter (cm ³)	joules (j)		61.02374		cubic inch (in ³)
cubic foot (ft ³)		0.000016387		cubic feet (ft ³)	liters (l)		1.093611		yard (yd)
cubic foot (ft ³)		16.387064		cubic meter (m ³)	meters (m)		3.2808333		feet (ft)
cubic inch (in ³)		1000000.0		cubic centimeter (cm ³)	meters (m)		39.37		inch (in)
cubic inch (in ³)		35.314666		centimeter (cm)	meters (m)		100.0		centimeter (cm)
cubic inch (in ³)		264.17		cubic foot (ft ³)	meters (m)		1760.0		yards (yd)
cubic meter (m ³)		0.00018939		gallons (gal)	miles (mi)		5280.0		feet (ft)
cubic meter (m ³)		0.33333		miles (mi)	miles (mi)		1.6093		kilometer (km)
cubic meter (m ³)		12		yards (yd)	miles (mi)		0.0032808		feet (ft)
feet (ft)		0.00030480		inches (in)	millimeters (mm)		0.03937		inch (in)
feet (ft)		0.30480		kilometer (km)	millimeters (mm)		0.001		meters (m)
feet (ft)		30.480		meters (m)	millimeters (mm)		0.01		centimeters (cm)
feet (ft)		304.80		centimeters (cm)	millimeters (mm)		39.3701		mils
feet (ft)		0.00067197		millimeters (mm)	millimeters (mm)		1000.0		microns (μ)
feet (ft)		0.001285		meters/grams (m/g)	millimeters (mm)		44.25		ft-lb/minute
feet (ft)		1.356		British Thermal Unit (BTU)	watts (w)		0.737562		ft-lb/sec
feet/pound (ft/lb)		0.1383		joules (j)	watts (w)		0.001341		horsepower
foot-pound (ft-lb)				kilogram/meter (kg/m)	watts (w)		3.414462		British Thermal Unit (BTU)
foot-pound (ft-lb)					watt-hours (w-hr)				
foot-pound (ft-lb)									

Temperature Conversion Chart

To use this chart, find your known temperature (°F) in the shaded column.

°C	°F	°C	°F	°C	°F	°C	°F	°C	°F
-45.0	-49.0	-17.2	1.0	10.6	51.0	38.3	101.0	66.1	151.0
-44.4	-48.0	-16.7	2.0	11.1	52.0	38.9	102.0	66.7	152.0
-43.9	-47.0	-16.1	3.0	11.7	53.0	39.4	103.0	67.2	153.0
-43.3	-46.0	-15.6	4.0	12.2	54.0	40.0	104.0	67.8	154.0
-42.8	-45.0	-15.0	5.0	12.8	55.0	40.6	105.0	68.3	155.0
-42.2	-44.0	-14.4	6.0	13.3	56.0	41.1	106.0	68.9	156.0
-41.7	-43.0	-13.9	7.0	13.9	57.0	41.7	107.0	69.4	157.0
-41.1	-42.0	-13.3	8.0	14.4	58.0	42.2	108.0	70.0	158.0
-40.6	-41.0	-12.8	9.0	15.0	59.0	42.8	109.0	70.6	159.0
-40.0	-40.0	-12.2	10.0	15.6	60.0	43.3	110.0	71.1	160.0
-39.4	-39.0	-11.7	11.0	16.1	61.0	43.9	111.0	71.7	161.0
-38.9	-38.0	-11.1	12.0	16.7	62.0	44.4	112.0	72.2	162.0
-38.3	-37.0	-10.6	13.0	17.2	63.0	45.0	113.0	72.8	163.0
-37.8	-36.0	-10.0	14.0	17.8	64.0	45.6	114.0	73.3	164.0
-37.2	-35.0	-9.4	15.0	18.3	65.0	46.1	115.0	73.9	165.0
-36.7	-34.0	-8.9	16.0	18.9	66.0	46.7	116.0	74.4	166.0
-36.1	-33.0	-8.3	17.0	19.4	67.0	47.2	117.0	75.0	167.0
-35.6	-32.0	-7.8	18.0	20.0	68.0	47.8	118.0	75.6	168.0
-35.0	-31.0	-7.2	19.0	20.6	69.0	48.3	119.0	76.1	169.0
-34.4	-30.0	-6.7	20.0	21.1	70.0	48.9	120.0	76.7	170.0
-33.9	-29.0	-6.1	21.0	21.7	71.0	49.4	121.0	77.2	171.0
-33.3	-28.0	-5.6	22.0	22.2	72.0	50.0	122.0	77.8	172.0
-32.8	-27.0	-5.0	23.0	22.8	73.0	50.6	123.0	78.3	173.0
-32.2	-26.0	-4.4	24.0	23.3	74.0	51.1	124.0	78.9	174.0
-31.7	-25.0	-3.9	25.0	23.9	75.0	51.7	125.0	79.4	175.0
-31.1	-24.0	-3.3	26.0	24.4	76.0	52.2	126.0	80.0	176.0
-30.6	-23.0	-2.8	27.0	25.0	77.0	52.8	127.0	80.6	177.0
-30.0	-22.0	-2.2	28.0	25.6	78.0	53.3	128.0	81.1	178.0
-29.4	-21.0	-1.7	29.0	26.1	79.0	53.9	129.0	81.7	179.0
-28.9	-20.0	-1.1	30.0	26.7	80.0	54.4	130.0	82.2	180.0
-28.3	-19.0	-0.6	31.0	27.2	81.0	55.0	131.0	82.8	181.0
-27.8	-18.0	0.0	32.0	27.8	82.0	55.6	132.0	83.3	182.0
-27.2	-17.0	0.6	33.0	28.3	83.0	56.1	133.0	83.9	183.0
-26.7	-16.0	1.1	34.0	28.9	84.0	56.7	134.0	84.4	184.0
-26.1	-15.0	1.7	35.0	29.4	85.0	57.2	135.0	85.0	185.0
-25.6	-14.0	2.2	36.0	30.0	86.0	57.8	136.0	85.6	186.0
-25.0	-13.0	2.8	37.0	30.6	87.0	58.3	137.0	86.1	187.0
-24.4	-12.0	3.3	38.0	31.1	88.0	58.9	138.0	86.7	188.0
-23.9	-11.0	3.9	39.0	31.7	89.0	59.4	139.0	87.2	189.0
-23.3	-10.0	4.4	40.0	32.2	90.0	60.0	140.0	87.8	190.0
-22.8	-9.0	5.0	41.0	32.8	91.0	60.6	141.0	88.3	191.0
-22.2	-8.0	5.6	42.0	33.3	92.0	61.1	142.0	88.9	192.0
-21.7	-7.0	6.1	43.0	33.9	93.0	61.7	143.0	89.4	193.0
-21.1	-6.0	6.7	44.0	34.4	94.0	62.2	144.0	90.0	194.0
-20.6	-5.0	7.2	45.0	35.0	95.0	62.8	145.0	90.6	195.0
-20.0	-4.0	7.8	46.0	35.6	96.0	63.3	146.0	91.1	196.0
-19.4	-3.0	8.3	47.0	36.1	97.0	63.9	147.0	91.7	197.0
-18.9	-2.0	8.9	48.0	36.7	98.0	64.4	148.0	92.2	198.0
-18.3	-1.0	9.4	49.0	37.2	99.0	65.0	149.0	92.8	199.0
-17.8	0.0	10.0	50.0	37.8	100.0	65.6	150.0	93.3	200.0

TEMPERATURE CONVERSION FORMULA

$$^{\circ}\text{C} = \frac{5}{9} (^{\circ}\text{F} - 32) \qquad ^{\circ}\text{F} = \frac{9}{5} ^{\circ}\text{C} + 32$$



Conduit Capacity Chart

Conduit Trade Size	1/2	3/4	1	1 1/4	1 1/2	2	2 1/2	3	3 1/2	4	
I.D. Inches	0.622	0.824	1.049	1.380	1.610	2.067	2.731	3.356	3.834	4.334	
Internal Area, In ²	0.304	0.533	0.864	1.496	2.036	3.356	5.858	8.846	11.545	14.753	
1 Conductor (53% fill)	0.161	0.283	0.458	0.793	1.079	1.778	3.105	4.688	6.119	7.819	
2 Conductors (31% fill)	0.094	0.165	0.268	0.464	0.631	1.040	1.816	2.742	3.579	4.573	
Conductors (40% fill)	0.122	0.213	0.346	0.598	0.814	1.342	2.343	3.538	4.618	5.901	
Cable OD Inches	Cable Area In ²	Numbers listed below are based on the 2008 NEC (40% fill) for 3 or more non-lead covered cables.									
0.100	0.008	15	26	43	76	104	170	244	375	504	648
0.125	0.012	9	17	27	48	66	109	156	240	322	414
0.150	0.018	6	11	19	33	46	75	108	166	224	288
0.175	0.024	5	8	14	24	34	55	79	122	164	211
0.200	0.031	3	6	10	19	26	42	81	93	126	162
0.225	0.040	3	5	8	15	20	33	48	74	99	128
0.250	0.049	1	4	6	12	16	27	39	60	80	103
0.275	0.059	1	3	5	10	13	22	32	49	66	85
0.300	0.071	1	2	4	8	11	18	27	41	56	72
0.325	0.083	1	1	4	7	9	16	23	35	47	61
0.350	0.096	1	1	3	6	8	13	19	30	41	52
0.375	0.110	1	1	3	5	7	12	17	26	35	46
0.400	0.126	1	1	2	4	6	10	15	23	31	40
0.425	0.142	1	1	1	4	5	9	13	20	27	35
0.450	0.159	1	1	1	3	5	8	12	18	24	32
0.475	0.177	0	1	1	3	4	7	10	17	22	28
0.500	0.196	0	1	1	3	4	6	9	15	20	25
0.525	0.216	0	1	1	2	3	6	8	13	18	23
0.550	0.238	0	1	1	1	3	5	8	12	16	21
0.575	0.260	0	1	1	1	3	5	7	11	15	19
0.600	0.283	0	0	1	1	2	4	6	10	14	18
0.625	0.307	0	0	1	1	2	4	6	9	12	16
0.650	0.332	0	0	1	1	1	4	5	8	11	15
0.675	0.358	0	0	1	1	1	3	5	8	11	14
0.700	0.385	0	0	1	1	1	3	5	7	10	13
0.725	0.413	0	0	1	1	1	3	4	7	9	12
0.750	0.442	0	0	1	1	1	3	4	6	8	11
0.775	0.472	0	0	0	1	1	2	4	6	8	10
0.800	0.503	0	0	0	1	1	2	3	5	7	10
0.825	0.535	0	0	0	1	1	1	3	5	7	9
0.850	0.567	0	0	0	1	1	1	3	5	6	8
0.875	0.601	0	0	0	1	1	1	3	4	6	8
0.900	0.636	0	0	0	1	1	1	3	4	6	8
0.925	0.672	0	0	0	1	1	1	2	4	5	7
0.950	0.709	0	0	0	1	1	1	2	4	5	7
0.975	0.747	0	0	0	1	1	1	1	3	5	6
1.000	0.785	0	0	0	1	1	1	1	3	5	6
1.025	0.825	0	0	0	0	1	1	1	3	4	6
1.050	0.866	0	0	0	0	1	1	1	3	4	5
1.075	0.908	0	0	0	0	1	1	1	3	4	5

Notice: 1. The reader is cautioned to consult the NEC for specific information regarding conduit fill.
 2. This Conduit Capacity Chart should only be used as a guide when attempting to estimate conduit fill.
 3. For additional information, the reader should refer to the National Electrical Code.



AWG Conductor Chart

COPPER CONDUCTOR DATA

The conductors used by Prysmian meet the applicable requirements of ASTM specifications B-3, B-33, B-173, B-174 and B-286 and Federal Specification QQ-W-343.

The following data covers the more commonly used conductor constructions in the electrical and electronics industry. Special constructions, not shown, are available or can be designed to meet specific requirements. It is suggested that the Prysmian Product Engineering Department be contacted before a specification is finalized.

AWG	STRANDING	TYPE STRANDING ⁽¹⁾	DIAMETER ⁽⁴⁾		AREA		WEIGHT		D.C. RESISTANCE 20°C ⁽²⁾				BREAK STR. LBS
			in	mm	circ. mils	sq. mm	lbs/Mft	kg/km	TIN COATING ⁽³⁾		BARE OF SILVER COATING		
									Ω/Mft	Ω/km	Ω/Mft	Ω/km	
32	7/40	Co or Bu	.0096	.254	100	.051	.21	.31	176.00	577.00	164.00	538.00	1.986
30	Solid 7/38	–	.010	.254	100	.051	.30	.45	113.00	371.00	104.00	340.00	3.157
		Bu	.012	.305	112	.057	.35	.52	106.00	348.00	92.60	303.00	
28	Solid 7/36	–	.01264	.321	159	.081	.48	.72	70.80	232.00	65.30	214.00	5.020
		Co	.015	.381	175	.089	.55	.82	67.50	221.00	59.30	194.00	
27	Solid 7/35	–	.0142	.361	202	.102	.61	.91	55.60	182.00	51.40	169.00	6.331
		Co or Bu	.017	.432	220	.111	.69	1.04	53.80	176.00	–	–	
26	Solid 7/34 10/36 19/38	–	.016	.404	253	.128	.77	1.14	44.50	146.00	41.00	135.00	7.983
		Co or Bu	.019	.483	278	.141	.87	1.29	42.50	139.00	37.30	122.00	
		Bu	.0193	.490	250	.127	.78	1.15	47.30	155.00	40.40	133.00	
		Bu or Co	.021	.533	304	.154	.97	1.44	38.90	128.00	34.10	112.00	
24	Solid 7/32 16/36 19/36	–	.0201	.511	404	.205	1.22	1.82	27.20	89.20	25.70	84.20	12.690
		Co or Bu	.024	.610	448	.227	1.38	2.05	25.70	84.20	23.10	75.90	
		Bu	.024	.610	400	.201	1.25	1.64	29.50	96.80	27.50	90.20	
		Co or Bu	.025	.635	475	.241	1.48	2.20	24.90	81.70	21.80	71.60	
22	Solid 7/30 19/34	–	.025	.643	643	.324	1.94	2.89	16.70	54.80	16.20	53.20	19.430
		Co or Bu	.030	.762	700	.355	2.19	3.26	16.60	54.40	14.80	48.60	
		Bu or Eq	.0315	.800	754	.382	2.35	3.50	15.50	50.80	13.80	45.10	
		–	.032	.813	1,020	.519	3.10	4.61	10.50	34.40	10.10	33.20	
20	Solid 7/28 10/30 19/32 26/34	Co or Bu	.038	.965		.562	3.49	5.19	10.30	33.80	9.33	30.60	30.890
		Bu	.037	.940	1,111	.507	3.14	4.67	11.40	37.40	10.40	34.00	
		Co, Bu or Eq	.040	1.02	1,000	.616	3.84	5.71	9.48	31.10	8.53	28.00	
		Bu	.039	.940	1,216	.523	3.28	4.88	11.30	37.10	–	–	
		–	.0359	.912	1,032	.653	3.90	5.80	–	–	8.05	26.40	
18	Solid 7/26 16/30 19/30 41/34	–	.0403	1.024	1,290	.823	4.92	7.32	6.77	22.20	6.39	21.00	49.120
		Co or Bu	.048	1.22	1,620	.897	5.55	8.26	6.45	21.20	5.55	19.20	
		Bu	.0475	1.207	1,770	.810	5.01	7.45	7.15	23.40	6.48	21.30	
		Co, Bu or Eq	.050	1.27	1,600	.963	5.95	8.85	6.10	20.00	5.46	17.90	
		Bu	.049	1.244	1,900	.824	5.09	7.08	7.08	23.20	6.60	21.60	
16	Solid 19/29 19/0117 26/30 65/34	–	.0508	1.29	1,627	1.31	7.81	11.60	4.47	14.70	4.16	13.60	78.100
		Bu or Eq	.057	1.45	2,580	1.23	7.52	11.20	4.82	15.80	4.27	14.00	
		Bu	.0585	1.50	2,426	1.32	8.02	11.90	4.39	14.40	4.13	13.50	
		Bu	.0606	1.54	2,601	1.32	8.15	12.10	4.39	14.40	3.99	13.10	
		Bu	.060	1.52	2,600	1.31	8.20	11.90	4.47	14.70	4.16	13.60	
14	Solid 7/0242 19/27 19/0147 41/30	–	.0641	1.63	2,581	2.08	12.4	18.50	2.68	8.79	2.52	8.28	124.200
		Co	.073	1.85	4,110	2.08	12.7	18.90	–	–	2.61	8.56	
		Co, Eq or Un	.071	1.80	4,100	1.94	12.1	18.00	3.05	10.00	2.71	8.88	
		Bu	.074	1.88	3,831	2.08	12.7	18.90	2.73	–	2.61	8.56	
		Bu	.077	1.96	4,106	2.08	12.9	19.20	2.81	9.22	2.53	8.30	
12	Solid 7/0305 19/25 19/0185 65/30	–	.0808	2.05	4,100	3.31	19.8	29.50	1.69	5.54	1.59	5.21	197.500
		Bu	.092	2.34	6,530	3.30	20.2	30.10	–	–	1.64	5.38	
		Co, Eq or Un	.0905	2.299	6,512	3.08	19.4	28.90	1.87	6.13	1.70	5.59	
		Cu	.0925	2.35	6,088	3.30	20.2	30.10	–	–	1.64	5.25	
		Bu	.094	2.388	6,503	3.29	20.8	31.10	1.82	5.97	1.64	5.25	
10	Solid 7/0385 19/0234 37/0169 105/30	–	.1019	2.588	6,500	5.26	31.4	46.80	–	–	1.00	3.28	314.500
		Co	.116	2.95	10,380	5.25	32.0	47.60	–	–	1.00	3.28	
		Bu	.117	2.97	10,376	5.27	32.0	47.60	–	–	.98	3.21	
		Co	.112	2.84	10,404	4.74	29.2	43.40	–	–	1.25	4.10	
		Bu	.126	3.20	9,361	5.32	33.8	49.20	1.10	3.61	.99	3.24	
8	7/0486 19/0295 133/29 168/30	Bu	.146	3.71	10,500	8.38	50.1	74.50	–	–	.65	2.13	
		Bu or Eq	.144	3.66	16,534	8.38	50.0	74.40	–	–	.65	2.13	
		Ro 19 x 7/29	.169	4.293	16,535	8.61	54.0	80.40	.71	2.33	–	–	
		Ro 7 x 24/30	.174	4.42	16,983	8.51	53.4	79.00	.70	2.30	–	–	
6	19/0374 133/27 266/30	Bu	.188	4.775	16,800	13.33	81.1	121.00	–	–	.40	1.30	
		Ro 19 x 7/27	.213	5.41	26,576	13.60	84.1	125.00	.43	1.41	–	–	
		Ro 7 x 38/30	.222	5.64	26,818	13.49	83.2	124.00	.44	1.44	–	–	
		–											
4	133/25 420/30	Ro 19 x 7/25	.257	6.53	26,600	21.61	135.0	201.00	.29	.95	–	–	
		Ro 7 x 60/30	.270	6.850	42,615	21.29	140.0	208.00	.28	.92	–	–	
2	665/30	Ro 19 x 35/30	.338	8.59	42,000	33.72	213.0	317.00	.18	.59	–	–	

(1) Bu - Bunched; Co - Concentric; Eq - Equilay; Ro - Rope; Un - Unilay

(2) Typical DC resistance values for uninsulated wires. Multiply by 1.04 for typical values after insulation

(3) Values are for tinned, heavy tinned, prefused, overcoated or topcoated conductors

(4) Does not meet UL conductor stranding requirements



Glossary

- Abrasion Resistance:** Resistance to surface wear.
- AC Alternating Current (a.c.):** Current in which the charge-flow periodically reverses and is represented by: $I = I_G \cos(2\pi f - t)$ where, I is the current, I_G is the amplitude, f the frequency, t the phase angle.
- Accelerated Aging:** A test that attempts to duplicate long-time environmental aging in comparatively short time spans.
- Accelerator:** A chemical additive which hastens a chemical reaction under specific conditions.
- Accordion:** (1) A retractile cable with a series of equally-spaced transverse folds. (2) A connector contact with a "Z" shaped flat spring to permit high deflection without overstress.
- Adapter:** A device that enables any or all of the following 1) different sizes or types of plugs to mate with one another or to fit into a telecommunications outlet/connector; 2) the rearrangement of leads; 3) large cables with numerous wires to fan out into smaller groups of wires, 4) interconnection between cables.
- Adhesive Bonded:** Cables bonded by adding an adhesive coating to the surface of the cable components, then joining and curing the adhesive to form a cable. See Bonded Cable.
- Administration:** The method for labeling, identification, documentation and usage needed to implement moves, additions and changes of the telecommunications infrastructure.
- Admittance:** The measure of the ease with which an alternating current flows in a circuit. The reciprocal of impedance.
- Aerial Cable:** A cable suspended in the air on poles or other overhead structure.
- Aging:** The change in properties of a material with time under specific conditions.
- Air Core Cable:** A cable in which the interstices in the cable core are not filled with a moisture barrier.
- Air-Handling Plenum:** A designated area, closed or open, used for environmental air.
- Air Spaced Coaxial Cable:** One in which air is essentially the dielectric material. A spirally wound synthetic filament, beads or braided filaments may be used to center the conductor.
- All-Rubber Cable:** A cable in which all interstices between conductors are filled with rubber compound.
- Alligator Clip:** A mechanical device shaped like alligator jaws used as a temporary connection on the end of interconnections wire.
- Alloy:** A metal formed by combining two or more different metals to obtain desirable properties.
- Aluminum Conductor:** An aluminum wire or group of wires not suitably insulated to carry electrical current.
- Aluminum-Steel Conductor:** A composite conductor made up of a combination of aluminum and steel wires.
- Ambient Temperature:** The temperature of a medium (gas or liquid) surrounding an object.
- American Wire Gauge (AWG):** The standard system used for designating wire diameter. The lower the AWG number, the larger the diameter. Also called the Brown and Sharpe (B&S) wire gauges.
- Ampacity:** See Current Carrying Capacity.
- Ampere:** The unit of current. One ampere is the current flowing through one ohm of resistance at one volt potential.
- Analog:** A signaling format that uses continuous physical variables such as voltage amplitude or frequency variations to transmit information.
- Anneal:** Relief of mechanical stress through heat and gradual cooling. Annealing copper renders it less brittle.
- Annular Conductor:** A number of wires stranded in three reversed concentric layers around a core.
- Annunciator:** A signaling device, usually electrically operated, that gives an audible or visual signal (or both) when energized.
- Anti-Oxidant:** A substance which prevents or slows down oxidation of material exposed to air.
- Appliance Wire and Cable:** A classification covering insulated wire and cable for internal wiring of appliances and equipment.
- Arc Resistance:** The time required for an arc to establish a conductive path in a material.
- Armored Cable:** A cable provided with a wrapping of metal for mechanical protection.
- Attenuation:** The decrease in magnitude of the power of a signal in transmission between points. Attenuation is usually measured in decibels per unit length at a specific frequency.
- Attenuation to Crosstalk Ratio (ACR):** The difference between attenuation and crosstalk, measured in dB, at a given frequency. Important characteristic in networking transmission to assure that signal sent down a twisted pair is stronger at the receiving end, after being attenuated, than are any interference signals imposed on that same pair by crosstalk from other pairs, represented by NEXT.
- Audio Frequency:** The range of frequencies audible to the human ear. Usually 20-20,000 Hz.
- Backbone:** A facility (e.g. pathway, cable or conductors) between telecommunications closets or floor distribution terminals, the entrance facilities and the equipment rooms within or between buildings.
- Backbone Cable or Wire:** Cable or wire found in the backbone; see Backbone.
- Balanced Line:** A cable having two identical conductors which carry voltages opposite in polarity and equal in magnitude with respect to ground.
- Balun:** A device for matching an unbalanced coaxial transmission line to a balanced two-wire system.
- Band Marking:** A continuous circumferential band applied to a conductor at regular intervals for identification.
- Banded Cable:** Two or more cables banded together by stainless steel strapping.
- Bandwidth:** A continuous range of frequencies extending between two limiting frequencies. Also referred to as a frequency band.
- Barrel-Packed:** Method of coiling into a fiber drum for shipment.
- Baseband:** In data transmission, the use of a dedicated end-to-end connection to carry a single channel only.
- Beaded Coax:** Coaxial cable with a dielectric consisting of beads made of various materials.
- Belt:** Number of layers of insulation on a conductor, or number of layers of jacket on a cable.
- Belted-Type Cable:** Multiple conductor cable having a layer of insulation over the assembled insulated conductors.
- Bend Loss:** A form of increased attenuation caused by (1) having an optical fiber curved around a restrictive radius of curvature or (2) microbends caused by minute distortions in the fiber imposed by externally induced forces.
- Bend Radius:** Radius of curvature that a fiber optic or metallic cable can bend without any adverse effects.
- Bifilar:** A winding made non-inductive by winding together (as one wire) two wires carrying current in opposite directions.
- Billion Conductor Feet (BCF):** A quantity derived by multiplying the number of conductors in a cable by the amount of cable. Usually used to indicate plant capacity or an annual requirement.
- Bimetallic Wire:** A wire formed of two different metals joined together (not alloyed). It can include wire with a steel core clad wire, or plated or coated wire.
- Binder:** A spirally served tape or thread used for holding assembled cable components in place awaiting subsequent manufacturing operations.
- Binding Post:** A device for clamping or holding electrical conductors in a rigid position.
- Bit:** One binary (0 or 1) digit.
- Blown Jacket:** Outer cable covering applied by controlled inflation of the cured jacket tube then pulling the cable through it.
- Bond Strength:** Amount of adhesion between bonded surfaces, e.g. in cemented ribbon cable.
- Bondable Wire:** An insulated wire treated to facilitate adherence to materials such as potting compounds. Also, magnet wires used in making coils when bonding the turns together is desired.
- Bonded Cable:** Cable consisting of pre-insulated conductors or multiconductor components laid-in parallel and bonded into a flat cable. See Solvent-Bonded; Adhesive-Bonded; Film-Bonded.
- Bonded Construction:** An insulation construction in which the glass braid and nylon jacket are bonded together.
- Bonding:** The permanent joining of metallic parts to form an electrically conductive path that will assure electrical continuity and the capacity to conduct safely any current likely to be imposed on it.
- Booster:** A device inserted into a line (or cable) to increase the voltage.
- Boot:** (1) Protective covering over a cable, wire or connector in addition to the normal jacketing or insulation. (2) A form placed around wire termination of a multiple-contact connector to contain the liquid potting compound before it hardens.
- Braid:** A fibrous or metallic group of filaments interwoven in cylindrical form to form a covering over one or more wires.
- Braid Angle:** The smaller of the two angles formed by the shielding strand and in the axis of the cable being shielded.
- Braid Carrier:** A spool or bobbin on a braid which holds one group of strands or filaments consisting of a specific number of ends. The carrier revolves during braiding operations.
- Braid Ends:** The number of strands used to make up one carrier. The strands are wound side by side on the carrier bobbin and lie parallel in the finished braid.

Glossary

- Braiding Machine:** Machine used to apply braids to wire and cable and to produce braided sleeving and braids for tying or lacing purposes. Braiding machines are identified by the number of carriers.
- Breakdown (Puncture):** A disruptive discharge through the insulation.
- Breakdown Voltage:** The voltage at which the insulation between two conductors breaks down.
- Breakout:** The point at which a conductor or group of conductors breaks out from a multiconductor cable to complete circuits at various points along the main cable.
- Bridge:** A device used to expand a local area network by forwarding frames between data link layers.
- Bridged Tap:** The multiple appearances of the same cable pair at several distribution points.
- British Standard Wire Gauge:** A modification of the Birmingham Wire Gauge and the legal standard of Great Britain for all wires. Also known as Standard Wire Gauge (SWG), New British Standard (NBS), English Legal Standard and Imperial Wire Guide.
- Broadband:** In data transmission, the use of a carrier signal, rather than direct modulation, to carry several simultaneous channels.
- Buffer:** (fiber optic) A soft material which mechanically isolates individual fibers in a fiber optic cable or bundle from small geometrical irregularities, distortions or roughness of adjacent surfaces.
- Buffing Stripper:** A motorized device for removing flat cable insulation by means of buffing wheels that melt the insulation and brush it away from the conductors. Also called Abrasion Stripper.
- Building Entrance Area:** See Entrance Room or Space, Telecommunications.
- Building Wire:** Wire used for light and power, 600 volts or less, usually not exposed to outdoor environment.
- Bunched Stranding:** A group of strands twisted together in a random manner and the same direction without regard to geometric arrangement of specific strands.
- Buncher:** A machine that twists wires together in random arrangement.
- Bundle:** (fiber optic) A number of fibers grouped together, usually carrying a common signal.
- Buried Cable:** A cable installed directly in the earth without use of underground conduit. Also called "direct burial cable."
- Bus:** Wire used to connect two terminals inside of an electrical unit.
- Bushing:** A mechanical device used as a lining for an opening to prevent abrasion to wire and cable.
- Butt:** Joining of two conductors end-to-end, with no overlap and with the axes in line.
- Butt Splice:** A splice wherein two wires from opposite ends butt against each other, or against a stop, in the center of a splice.
- Butt Wrap:** Tape wrapped around an object or conductor in an edge-to-edge condition.
- Byte:** Typically a group of eight binary digits.
- Cable:** A stranded conductor with or without insulation and other coverings (single-conductor cable), or a combination of conductors (multiple-conductor cable). In fiber optics, a jacketed fiber or jacketed bundle in a form which can be terminated.
- Cable Assembly:** Typically, the cable and associated connectors; ready to install.
- Cable Clamp:** A device used to give mechanical support to the wire bundle or cable at the rear of a plug or receptacle.
- Cable Clamp Adapter:** A mechanical adapter that attaches to the rear of a plug or receptacle to allow the attachment of a cable clamp.
- Cable Core:** The portion of an insulated cable lying under a protective covering.
- Cable Core Binder:** A wrapping of tapes or cords around the conductors of a multiple-conductor cable used to hold them together.
- Cable Filler:** The material used in multiple-conductor cables to occupy the interslices formed by the assembly of the insulated conductors, thus forming a cable core.
- Cable Rack:** The vertical or horizontal open support (usually made of aluminum or steel) that is attached to a ceiling or wall.
- Cable Sheath:** The overall protective covering applied to cables.
- Cable Tray:** A ladder, trough, solid-bottom or channel raceway system intended for, but not limited to, the support of telecommunications media (e.g., cable).
- Cable Vulcanizer:** Compression molding machine used to repair cable jacketing that has had a part removed for splicing, for adding connectors or other devices or for replacing damaged sections.
- Cabling:** (1) A combination of all cables, wire, cords and connecting hardware. (2) Twisting together two or more insulated conductors by machine to form a cable. In fiber optics, a method by which a group or bundle of fibers is mechanically assembled.
- Cabling Factor:** Used in the formula for calculating the diameter of an unshielded, unjacketed cable. $D = Kd$, where D is the cable diameter, K is the factor and d is the diameter of one insulated conductor.
- Campus:** The building and grounds of a complex (e.g. a university, college, industrial park or military establishment).
- Canadian Standards Association (CSA):** A non-profit independent organization which operates a listing service for electrical and electronic materials and equipment. The Canadian counterpart of the Underwriter's Laboratories.
- Capacitance:** The ratio of the electrostatic charge on a conductor to the potential difference between the conductors required to maintain that charge.
- Capacitance, Direct:** The capacitance measured from one conductor to another conductor through a single insulating layer.
- Capacitance, Mutual:** The capacitance between two conductors (typically of a pair) with all other conductors, including shield, short circuited to ground.
- Carolprene®:** Proprietary rubber compound.
- Carrier:** The woven element of a braid consisting of one or more ends (strands) which creates the interlaced effect. Also, a spindle, spool, tube, or bobbin (on a braiding machine) containing yarn or wire, employed as a braid.
- Cellular Plastics:** Expanded or "foam," consists of individual closed cells of inert gas suspended in a plastic medium, resulting in a desirable reduction of the dielectric constant.
- Central Office:** The place where communications common carriers terminate customer lines and locate switching equipment that interconnects those lines.
- Certificate of Compliance (C of C):** A written statement; normally generated by a quality control department, which states that the product being shipped meets customer's specifications.
- Certified Test Report (CTR):** A report reflecting actual test data on the cable shipped. Tests are normally conducted by the quality control department, and show that the product being shipped meets the required test specifications.
- Characteristic Impedance:** The impedance that, when connected to the output terminals of a transmission line of any length, makes the line appear indefinitely long.
- Chlorosulfonated Polyethylene (CSPE):** A rubbery polymer used for insulations and jackets. Manufactured by E.I. DuPont under the trade name of Hypalon®.
- Cigarette Wrap:** Tape insulation wrapped longitudinally instead of spirally over a conductor.
- Circuit:** A complete path over which electrons can flow from the negative terminals of a voltage source through parts and wires to the positive terminals of the same voltage source.
- Circuit Sizes:** A popular term for building wire sizes 14 through 10 AWG.
- Circular Mil:** The area of a circle one mil (.001") in diameter; 7.854×10^{-7} sq. in. Used in expressing wire cross sectional area.
- Cladding:** Method of applying a layer of metal over another metal whereby the junction of the two metals is continuously welded. In fiber optics, a sheathing intimately in contact with the core of a higher refractive index material which serves to provide optical insulation and protection to the reflection interface.
- Closed End Splice:** An insulated splice in which two or more wires overlap and enter the splice from the same end of the barrel.
- Closet, Telecommunications:** An enclosed space for housing telecommunications equipment, cable terminations and cross-connect cabling. The closet is the recognized location of the cross-connect between the backbone and horizontal facilities.
- Coaxial Cable:** A cable consisting of two cylindrical conductors with a common axis, separated by a dielectric.
- Coaxial Connector:** A connector that has a coaxial construction and is used with coaxial cable.
- Coherent Source:** (fiber optic) A light source which emits a very narrow, unidirectional beam of light of one wavelength (monochromatic).
- Coil Effect:** The inductive effect exhibited by a spiral-wrapped shield, especially above audio frequencies.
- Cold Flow:** Permanent deformation of the insulation due to mechanical force of pressure (not due to heat softening).
- Color Code:** A color system for wire or circuit identification by use of solid colors, tracers, braids, surface printing, etc.
- Commercial Building:** A building or portion thereof, that is intended for office use.

Glossary

- Common Axis Cabling:** In multiple cable constructions, a twisting of all conductors about a “common axis” to result in smaller diameter constructions. Tends to result in greater susceptibility to electromagnetic and electrostatic interference.
- Compact Conductor:** Stranded conductor rolled to deform the round wires to fill the normal interstices between the wires in a strand.
- Composite (Clad) Wire:** A wire having a core of one metal with a fused outer shell of different metals.
- Composite Conductor:** Two or more strands of different metals assembled and operated in parallel.
- Compound:** An insulating or jacketing material made by mixing two or more ingredients.
- Compression Cable:** A pipe type cable in which the pressure medium is separated from the insulation by a membrane or sheath.
- Concentric:** A central core surrounded by one or more layers of helically wound strands in a fixed round geometric arrangement.
- Concentric-Lay Cable:** A concentric-lay conductor, or a multiple-conductor cable composed of a central core surrounded by one or more layers of helically laid insulated conductors.
- Concentric Strand:** A strand that consists of a central wire or core surrounded by one or more layers of spirally laid wires.
- Concentricity:** The measurement of the location of the center of the conductor with respect to the geometric center of the circular insulation.
- Conductance:** The ability of a conductor to carry an electric charge. The ratio of the current flow to the potential difference causing the flow. The reciprocal of resistance.
- Conductivity:** The capacity of a material to carry electrical current—usually expressed as a percentage of copper conductivity (copper being 100%).
- Conductor:** A wire (or combination of wires not insulated from one another) suitable for carrying electric current.
- Conduit:** A rigid or flexible metallic or nonmetallic raceway of circular cross-section through which cables can be pulled or housed.
- Connecting Hardware:** A device providing mechanical cable terminations.
- Connector:** A device used to provide rapid connect/disconnect service for electrical cable and wire terminations.
- Contact:** The part of a connector which actually carries the electrical current, and are touched together or separated to control the flow.
- Contact Inspection Hole:** A hole in the cylindrical rear portion of contact used to check the depth to which a wire has been inserted.
- Contact Size:** The largest size wire which can be used with the specific contact. Also, the diameter of the engagement end of the pin.
- Continuity Check:** A test to determine whether electrical current flows continuously throughout the length of a single wire or individual wires in a cable.
- Continuous Vulcanization:** Simultaneous extrusion and vulcanization of rubber-like wire coating materials.
- Contra-helical:** Cable spiralling in an opposite direction than the preceding layer within a wire or cable.
- Control Cable:** A multi-conductor cable made for operation in control of signal circuits.
- Controlled Impedance Cable:** Package of two or more insulated conductors where impedance measurements between respective conductors are kept essentially constant throughout the entire length.
- Copolymer:** A compound resulting from the polymerization of two different monomers.
- Copper-Clad:** Steel with a coating of copper welded to it before drawing as opposed to copper-plated. Synonymous with Copperweld.
- Copperweld:** The trade name of Flexo Wire Division (Copperweld Steel Corp.) for their copper-clad steel conductors.
- Cord:** A small, flexible insulated cable.
- Cord Set:** Portable cords fitted with a wiring device at one or both ends.
- Cord, Telecommunications:** A cable using stranded conductors for flexibility, as in distribution cords or line cords. Line cords can also use tinsel conductors.
- Core:** In cables, a component or assembly of components over which other materials are applied, such as additional components, shield, sheath or armor. In fiber optics, the transparent glass or plastic section with a high refractive index through which the light travels by internal reflections.
- Corona:** A discharge due to ionization of air around a conductor due to a potential gradient exceeding a certain critical value.
- Corona Resistance:** The time that the insulation will withstand a specified level of field-intensified ionization that does not result in the immediate complete breakdown of the insulation.
- Corrosion:** The destruction of the surface of a metal by chemical reaction.
- Coupling Loss:** (fiber optic) Signal losses due to small differences in numerical aperture, core diameter, core concentricity and tolerances in splicing connectors when two fibers are aligned. Also known as Splicing Loss and Transfer Loss.
- Coupling Ring:** A device used on cylindrical connectors to lock plug and receptacle together.
- Coverage:** The calculated percentage which defines the completeness with which a metal braid covers the underlying surface. The higher percentage of coverage, the greater the protection against external interference.
- Covering:** Textile braid or jacket of rubber, plastics or other materials applied over wire and cables to provide mechanical protection and identification.
- Crazing:** The minute cracks on the surface of plastic materials.
- Creep:** The dimensional change with time of a material under load.
- Creepage:** The conduction of electricity across the surface of a dielectric.
- Creepage Path:** The path across the surface of a dielectric between two conductors.
- Creepage Surface:** An insulating surface which provides physical separation as a form of insulation between two electrical conductors of different potential.
- Crimp:** Act of compressing a connector barrel around a cable in order to make an electrical connection.
- Crimp Termination:** Connection in which a metal sleeve is secured to a conductor by mechanically crimping the sleeve with pliers, presses or automated crimping machines.
- Cross-Connect:** A facility enabling the termination of cable elements and their interconnection, and/or cross-connection, primarily by means of a patch cord or jumper.
- Cross-Linked:** Inter-molecular bonds between long-chain thermoplastic polymers by chemical or electron bombardment means. The properties of the resulting thermosetting material are usually improved.
- Crosstalk:** Undesired electrical currents in conductors caused by electromagnetic or electrostatic coupling from other conductors or from external sources. Also, leakage of optical power from one optical conductor to another.
- CSA:** Canadian Standards Association.
- C-SJ:** Same as SJ except extra-flexible conductor.
- C-SJO:** Same as SJO except extra-flexible conductor.
- Cure:** To change the physical properties of a material by chemical reaction.
- Curing Cycle:** The time, temperature and pressure required for curing.
- Curl:** The degree to which a wire tends to form a circle after removal from a spool. An indication of the ability of the wire to be wrapped around posts in long runs.
- Current:** The rate of transfer of electricity. Practical unit is the ampere which represents the transfer of one coulomb per second. In a simple circuit, current (I) produced by a cell or electromotive force (E) when there is an external resistance (R) and internal resistance (r) is:
- $$I = \frac{E}{R+r}$$
- Current Carrying Capacity:** The maximum current an insulated conductor can safely carry without exceeding its insulation and jacket temperature limitations.
- Customer Premises:** Building(s) with grounds and appurtenances (belongings) under the control of the customer.
- Cut-Through Resistance:** The ability of a material to withstand mechanical pressure, usually a sharp edge or small radius, without separation.
- Cycle:** The complete sequence including reversal of the flow of an alternating electric current.
- Decibel (dB):** A unit to express differences of power level. Used to express power gain in amplifiers or power loss in passive circuits or cables.
- Delay Line:** A cable made to provide very low velocity of propagation with long electrical delay for transmitted signals.
- Demarcation Point:** A point where the operational control or ownership changes.
- Depth of Crimp:** Thickness of the crimped portion of a connector measured between two opposite points on the crimped surface.
- Derating Factor:** A factor used to reduce the current carrying capacity of a wire when used in environments other than that for which the value was established.
- Detector:** (fiber optic) A device that picks up light from fiber and converts the information into an electrical signal.
- Device, As Related to a Work Station:** An item such as a telephone, personal computer or graphic or video terminal.

Glossary

- Device, As Related to Protection:** A protector, a protector mount, a protector unit or a protector module.
- Dielectric:** An insulating medium which intervenes between two conductors and permits electrostatic attraction and repulsion to take place across it.
- Dielectric Breakdown:** The voltage required to cause an electrical failure or breakthrough of the insulation.
- Dielectric Constant (K):** The ratio of the capacitance of a condenser with dielectric between the electrodes to the capacitance when air is between the electrodes. Also called Permittivity and Specific Inductive Capacity.
- Dielectric Loss:** Power dissipated in an insulating medium as the result of the friction caused by molecular motion when an AC electric field is applied.
- Dielectric Strength:** The voltage which an insulation can withstand before breakdown occurs. Usually expressed as a voltage gradient (such as volts per mil).
- Dielectric Test:** A test in which a voltage higher than the rated voltage is applied for a specified time to determine the adequacy of the insulation under normal conditions.
- Digital:** Transmission data representative by discrete characters.
- Dip Coating:** An insulating coating applied to the conductor by passing the conductor through an applicator containing liquid insulating medium.
- Direct Burial Cable:** A cable installed directly in the earth.
- Direct Capacitance:** The capacitance measured directly from conductor to conductor through a single insulating layer.
- Direct Current (d.c.):** An electric current which flows in only one direction.
- Direct Current Resistance (DCR):** The resistance offered by any circuit to the flow of direct current.
- Direction of Lay:** The lateral direction in which the strands of a conductor run over the top of the cable conductor as they recede from an observer looking along the axis of the conductor or cable. Also applies to twisted cable.
- Discrete Wiring:** Wire or wires having distinct identity and purpose.
- Dispersion:** (fiber optic) The variation of the refractive index of a material with wavelength, causing light of different wavelengths to travel at different velocities in the material.
- Disruptive Discharge:** A sudden, large increase in current through an insulation medium due to the complete failure of the medium under the electrostatic stress.
- Dissipation Factor:** The tangent of the loss angle of the insulating material. (Also referred to as loss tangent, $\tan \delta$, and approximate power factor.)
- Distribution Cable:** In telecommunications and CATV systems, the transmission cable between the distribution amplifier and the drop wire.
- Distribution Frame:** A structure with terminations for connecting the permanent cabling of a facility in such a manner that interconnection or cross-connections may be readily made.
- Disturbed Conductor:** A conductor that receives energy generated by the field of another conductor or an external source such as a transformer.
- Drain Wire:** In a cable, the uninsulated wire laid over the component or components and used as a ground connection.
- Draw Feed Stock:** Rod or wire that is subsequently drawn to a smaller size.
- Drawing:** In wire manufacture, pulling the metal through a die or series of dies to reduce diameter to a specified size.
- Drop Ceiling:** See False Ceiling.
- Drop Wire:** In telecommunications and CATV systems, the transmission cable from the distribution cable to a dwelling.
- Dual Coaxial Cable:** Two individually insulated conductors laid parallel or twisted and placed within an overall shield and sheath.
- Duct:** 1) A single enclosed raceway for wires or cables. See also Conduit, Raceway; 2) a single enclosed raceway for wires or cables usually used in soil or concrete; 3) an enclosure in which air is moved. Generally part of the HVAC system of a building.
- Duplex:** Two way data transmission on a four-wire transmission line or two fiber.
- Duplex Cable:** (1) A cable composed of two insulated single-conductor cables twisted together. (2) A cable composed of two fibers, typically 62.5/125 mm multimode, placed in parallel under a thermoplastic sheath.
- Duplex Parallel:** Typically used in the thermocouple industry to denote two parallel conductors of dissimilar metals insulated in parallel without twist and jacketed. Commonly applied to thermocouple grades and extension wires.
- Eccentricity:** Like concentricity, a measure of the center of a conductor's location with respect to the circular cross section of the insulation. Expressed as a percentage of displacement of one circle within the other.
- Eddy Current:** Circulating currents induced in conducting materials by varying magnetic fields.
- Elastomer:** A rubber or rubber-like material which will stretch repeatedly to 200 percent or more and return rapidly and with force to its approximate original shape.
- Electro-Tinning:** Electrolytic process of tinning wire using pure tin.
- Electrode:** A conductor through which a current enters or leaves a nonmetallic conductor.
- Electromagnetic Coupling:** Energy transfer by means of a varying magnetic field.
- Electromagnetic Field:** A rapidly moving electric field and its associated moving magnetic field.
- Electromagnetic Induction:** The production of a voltage in a coil due to a change in the number of magnetic lines of forces (flux linkages) passing through the coil.
- Electromagnetic Interference (EMI):** The interference in signal transmission or reception resulting from the radiation of electrical and magnetic fields. Synonym: Radio Frequency Interference.
- Electromotive Force (e.m.f.):** Pressure or voltage. The forces which cause current to flow in a circuit.
- Electronic Wire and Cable:** A length of conductive or semiconductive material used in an electronic application.
- Electrostatic:** Pertaining to static electricity, or electricity at rest. An electric charge, for example.
- Elongation:** The fractional increase in the length of a material stressed in tension.
- Embossing:** A marker identification by means of thermal indentation leaving raised lettering on the sheath material of cable.
- Emergency Overload:** Load which occurs when larger than normal currents are carried through a cable or wire over a certain period of time.
- Enameled Wire:** A conductor with a baked-on enamel film insulation. In addition to magnet wire, enameled insulation is used on thermocouple type wires and other wires.
- Ends:** In braiding, the number of essentially parallel wires of threads on a carrier.
- Energize:** To apply rated voltage to a circuit or device in order to activate it.
- Entrance Facility, Telecommunications:** An entrance to a building for both public and private network service cables (including antennae) including the entrance point at the building wall and continuing to the entrance room or space.
- Entrance Point, Telecommunications:** The point of emergence of telecommunications conductors through an exterior wall, a concrete floor slab or from a rigid metal conduit or intermediate metal conduit.
- Entrance Room or Space, Telecommunications:** A space in which the joining of inter- or intra-building telecommunications backbone facilities takes place. An entrance room may also serve as an equipment room.
- Equilay:** More than one layer of helically laid wires with the direction of lay reversed for successive layers, but with the length of lay the same for each layer.
- Equipment Room, Telecommunications:** A centralized space for telecommunications equipment that serves the occupants of the building. An equipment room is considered distinct from a telecommunications closet because of the nature of complexity or the equipment.
- Etched Wire:** A process applied to fluoroplastic wire in which the wire is passed through a sodium bath to create a rough surface to allow epoxy resin to bond the fluoroplastic.
- Exit Angle:** The angle between the output radiation vectors and the axis of the fiber or fiber bundle.
- External Interference:** The effects of electrical waves or fields which cause sounds other than the desired signal. Static.
- External Wiring:** Electronic wiring which interconnects subsystems within the system.
- Extruded Cable:** Cable with conductors which are uniformly insulated and formed by applying a homogeneous insulation material in a continuous extrusion process.
- Extrusion:** Method of continuously forcing plastic, rubber, or elastomer material through an orifice to apply insulation or jacketing over a conductor or cable core.
- False Ceiling:** A ceiling that creates an area or space between the ceiling material and the structure above the material. Synonym: Drop Ceiling, Suspended Ceiling.
- Farad:** A unit of electrical capacity.
- Fatigue Resistance:** Resistance to metal crystallization which leads to conductors or wires breaking from flexing.
- Feed-Through Insulators:** Insulators that carry a metal conductor through the chassis while preventing the "hot" lead from shorting to the ground chassis.

Glossary

- Feedback:** Energy that is extracted from a high-level point in a circuit and applied to a lower level. Positive feedback reduces the stability of a device and is used to increase the sensitivity or produce oscillation in a system. Negative feedback, also called inverse feedback, increases the stability of a system as the feedback improves stability and fidelity.
- Feeder Cable:** In telecommunication or CATV systems, the transmission cable from the head end (signal pickup) to the trunk amplifier. Also called a trunk cable.
- Feedthrough:** (1) A conductor that connects patterns on opposite sides of a PCB. Also called Interfacial connection. (2) A connector or terminal block, usually having double-ended terminals which permit simple distribution and bussing of electrical circuits.
- Ferrous:** Composed of and/or containing iron. A ferrous metal exhibits magnetic characteristics.
- Ferrule:** A short tube used to make solderless connections to shielded or coaxial cable.
- Fiber:** A thread or threadlike structure. Also, a single discrete element used to transmit optical (light wave) information.
- Fiber Dispersion:** (fiber optic) Pulse spreading in a fiber caused by differing transit times of various modes.
- Fiber Optics:** A lightwave or optical communications system in which electrical information is converted to light energy, transmitted to another location through optical fibers, and is there converted back into electrical information.
- Fiber Tubing:** A loose, crush-resistant cylinder applied over individual fibers to provide mechanical protection.
- Field:** An area of influence around a magnet or electric charge.
- Field Coil:** A suitable insulated winding to be mounted on a field pole to magnetize it.
- Figure 8 Cable:** An aerial cable configuration in which the conductors and the steel strand which supports the cable are integrally jacketed. A cross-section of the finished cable approximates the figure "eight."
- Filament:** Fiber characterized by extreme length.
- Filled Cable:** A telephone cable construction in which the cable core is filled with a material that will prevent moisture from entering or passing through the cable.
- Filler:** (1) A material used in multiconductor cables to occupy large interstices formed by the assembled conductors. (2) An inert substance added to a compound to improve properties or decrease cost.
- Film:** A thin plastic sheet.
- Fine Stranded Wire:** Stranded wire with component strands of 36 AWG or smaller.
- Firestop:** A material, device or assembly of parts installed in a cable system in a fire-rated wall or floor to prevent passage of flame, smoke or gasses through the rated barrier.
- Flame Resistance:** The ability of a material not to propagate flame once the heat source is removed.
- Flammability:** The measure of the material's ability to support combustion.
- Flashover:** A disruptive discharge around or over the surface of a solid or liquid insulator.
- Flat Braid:** A woven braid of tinned copper strands rolled flat at time of manufacture to a specified width.
- Flat Cable:** A cable with two smooth or corrugated but essentially flat surfaces.
- Flat Conductor:** A wire having a rectangular cross-section as opposed to a round or square conductor.
- Flat Conductor Cable:** A cable with a plurality of flat conductors.
- Flexfoil®:** Proprietary aluminum laminated shielding tapes.
- Flex Life:** The measurement of the ability of a conductor or cable to withstand repeated bending.
- Flexibility:** The ease with which a cable may be bent.
- Flexible:** That quality of a cable or cable component which allows for bending under the influence of outside force, as opposed to limpness which is bending due to the cable's own weight.
- Floating:** Referring to a circuit which has no connection to ground.
- Flux:** (1) The lines of force which make up an electrostatic field. (2) The rate of flow of energy across or through a surface. (3) A substance used to promote or facilitate fusion.
- FNCC:** Federal Networking Council (formerly FRICC).
- Foamed Plastics:** See Cellular Plastic.
- Foil:** A thin, continuous sheet of metal.
- Free Connector:** A connector for attachment to the free end of a wire or cable.
- Frequency:** The number of times a periodic action occurs in a unit of time. The number of cycles that an electric current completes in one second.
- Frequency Response:** The characteristic of a device denoting the range of frequencies over which it may be used effectively.
- Funnel Entry:** Flared or widened entrance to a terminal or connector wire barrel.
- Fuse Wire:** Wire made from an alloy that melts at a relatively low temperature.
- Fused Coating:** A metallic coating which has been melted and solidified, forming a metallurgical bond to the base material.
- Fused Conductors:** Individual strands of heavy tinned copper wire stranded together and then bonded together by induction heating.
- Fused Spiral Tape:** A PTFE insulated hookup wire. The spiral wrapped conductor is passed through a sintering oven where overlaps are fused together.
- Gain:** The increase of voltage, current or power over a standard or previous reading. Usually expressed in decibels.
- Galvanometer:** An instrument for detecting or measuring small electrical current.
- Gas-Filled Cable:** A self-contained pressure cable in which the pressure medium is an inert gas having access to the insulation.
- Gauge:** A term used to denote the physical size of a wire.
- Giga:** A numerical prefix denoting one billion (10⁹).
- Gigahertz (GHz):** A unit of frequency equal to one billion hertz.
- Gimmick:** A short length of wire soldered onto a circuit component and used as a small adjustable capacitor.
- Graded-Index:** A type of optical fiber in which the refractive index of the core is in the form of a parabolic curve, decreasing toward the cladding. This type of fiber provides high bandwidth capabilities.
- Ground:** A conducting connection, whether intentional or accidental, between an electrical circuit (e.g. telecommunications) or equipment and the earth, or to some conducting body that serves in place of the earth.
- Ground Conductor:** A conductor in a transmission cable or line that is grounded.
- Ground Insulation:** The insulation used between a winding and the magnetic core or other structural parts, usually at ground potential.
- Ground Loop:** The generation of undesirable current flow within a ground conductor, owing to the circulation currents which originate from a second source of voltage.
- Ground Plane:** Expanded copper mesh which is laminated into some flat cable constructions as a shield.
- Ground Potential:** Zero potential with respect to the ground or earth.
- Hard Drawn Copper Wire:** Copper wire that has not been annealed after drawing.
- Harness:** An arrangement of wires and cables usually with many breakouts, which have been tied together or pulled into a rubber or plastic sheath, used to interconnect an electric circuit.
- Hash Mark Stripe:** A non-continuous helical stripe applied to a conductor for identification.
- Heat Distortion:** Distortion of flow of a material or configuration due to the application of heat.
- Heat Seal:** Method of sealing a tape wrap jacket by means of thermal fusion.
- Heater Cord:** Flexible stranded copper conductor, cotton wrapped, with rubber insulation and asbestos roving.
- Helical Stripe:** A continuous, colored, spiral stripe applied to a conductor for circuit identification.
- Helix:** Spiral winding.
- Henry:** The unit of inductance.
- Hertz (Hz):** A term replacing cycles-per-second as an indication of frequency.
- Heterogeneous Insulation:** A cable insulating system composed of two or more layers of different insulating materials.
- High-Temperature Wire and Cable:** Electrical wire and cables having thermal operating characteristics of 150°C and higher.
- High Voltage:** Generally, a wire or cable with an operating voltage of over 600 volts.
- Holding Strength:** Ability of a connector to remain assembled to a cable when under tension.
- Homogeneous Insulation:** A complete cable insulation structure whose components cannot be identified as layers of different materials.
- Hook-up Wire:** A wire used for low-current, low-voltage (under 1000 volts) applications within enclosed electronic equipment.
- Horizontal Cabling:** The wiring/cabling between the telecommunications outlet/connector and the horizontal cross-connect.
- Horizontal Cross-Connect:** A cross-connect of horizontal cabling to other cabling, e.g. horizontal, backbone or equipment.
- Hot Stamping:** Method of alpha numerical coding. Identification markings are made by pressing heated type and marking foil into softened insulation surfaces. See Surface Printing.
- Hot Tin Dip:** A process of passing bare wire through a bath of molten tin to provide a coating.
- Hybrid Cable:** An assembly of two or more cables (of the same or different types or categories) covered by one overall sheath.

Glossary

Hygroscopic: Capable of absorbing moisture from the air.

Hypalon®: DuPont's trade name for their chlorosulfonated polyethylene, an ozone-resistant synthetic rubber.

Impact Tool: Device used to punch new conductor onto IDs. This tool is typically equipped with a cutting blade for either 66 or 110 blocks.

Impedance: The total opposition that a circuit offers to the flow of alternating current or any other varying current at a particular frequency. It is a combination of resistance R and reactance X, measured in Ω .

Impedance-Matching Transformer: A transformer designed to match the impedance of one circuit to that of another (BALUN).

Impulse: A surge of unidirectional polarity.

Impulse Strength: The voltage breakdown of insulation under voltage surges on the order of microseconds in duration.

Impulse Test: An insulation test in which the voltage applied is an impulse voltage of specified wave shape.

Incoherent Source: (fiber optic) A light source which emits wide, diffuse beams of light of many wave lengths.

Index-Matching Fluid: (fiber optic) Fluid with refractive index same as fiber core; used to fill air gap between fiber ends at connectors.

Index of Refraction: The ratio of light velocity in a vacuum to its velocity in a given transmitting medium.

Inductance: The property of a circuit or circuit element that opposes a change in current flow, thus causing current changes to lag behind voltage changes. It is measured in henrys.

Inductive Coupling: Crosstalk resulting from the action of the electromagnetic field of one conductor on the other.

Infrastructure, Telecommunications: A collection of those telecommunications components, excluding equipment, that together provide the basic support for the distribution of all information within a building or campus.

Insertion Loss: As measure of the attenuation of a device by determining the output of a system before and after the device is inserted into the system.

Insertion Tool: A small, hand-held tool used to insert contacts into a connector.

Insulated Wire: A conductor of electricity covered with a non-conducting material.

Insulating Joint: A device which mechanically couples and electrically insulates the sheath and armor of contiguous lengths of cable.

Insulation: A material having high resistance to the flow of electric current. Often called a dielectric in radio frequency cable.

Insulation Adhesion: The degree of tightness of the insulation over the base conductor, measured in terms of force required to remove a specified length of insulation from the wire.

Insulation Crimp: The area of a terminal, splice or contact that has been formed around the insulation of the wire.

Insulation Grip: Extended cylinders at the rear of crimp-type contacts designed to accept the bared wire and a small length of its insulation.

Insulation Piercing: A method of crimping whereby lances cut the insulation of the wires and enter into the strands to make electrical contact.

Insulation Resistance: The ratio of the applied voltage to the total current between two electrodes in contact with a specific insulation, usually expressed in meg Ω -M feet.

Insulation System: All of the insulation materials used to insulate a particular electrical or electronic product.

Integral Belt: A layer of insulation or semiconductive material applied by extrusion over two or more insulated, twisted or parallel conductors, to form a round, smooth diameter.

Interconnect: A connection scheme that provides for the direct connection of individual cables to another cable or to an equipment cable without a patch cord.

Interconnecting Cable: The wiring between modules, between units or the larger portions of a system.

Interconnecting Wire: The physical wiring between components (outside a module), between modules, between units or between larger portions of a system or systems.

Interconnection: Mechanically joining devices together to complete an electrical circuit.

Interface: The two surfaces on the contact side of both halves of a multiple-contact connector which face each other when the connector is assembled.

Intermediate Cross-Connect: A cross-connect between 1st level and 2nd level backbone cabling.

Internal Wiring: Electronic wiring which interconnects components, usually within a sealed subsystem.

Interstices: Voids or valleys between individual strands in a conductor or between insulated conductors in a multiconductor cable.

Ionization Voltage (Corona Level): The minimum value of falling rms voltage which sustains electrical discharge within the vacuous or gas-filled spaces in the cable construction or insulation.

Irradiation: In insulations, the exposure of the material to high energy emissions for the purpose of favorably altering the molecular structure.

Jack: A plug-in type terminal widely used in an electronic apparatus for temporary connections.

Jacket: An outer protective sheath over primary insulation, braids, shields, cable components or over the cable itself. In fiber optics, a covering, over a fiber, bundle of fibers or cable which protects against the environment.

JAN Specification: Joint Army-Navy specification (replaced by current Military Specifications).

Jumper: An assembly of twisted pairs without connectors, used to join telecommunications circuits/links at the cross connect.

Junction: A point in a circuit where two or more wires are connected.

Keying: The mechanical feature of a connector system that guarantees correct orientation of a connection, or prevents the connection to a jack, or to an optical fiber adapter of the same type intended for another purpose.

Kynar®: Pennwalt trade name for polyvinylidene fluoride. Typically used as insulation for wire wrap wire.

Lacing and Harnessing: A method of grouping wires by securing them in bundles of designated patterns.

Lacquer: A liquid resin or compound applied to textile braid to prevent fraying, moisture absorption, etc.

Laminated Tape: A tape consisting of two or more layers of different materials bonded together.

Laser Diode: (fiber optic) A semiconductor diode that, when pulsed, a laser diode emits coherent light.

Launch Angle: (fiber optic) The angle between the radiation vector and the axis of the fiber or fiber bundle.

Lay: The length measured along the axis of a wire or cable required for a single strand (in stranded wire) or conductor (in cable) to make one complete turn about the axis of the conductor or cable.

Layer: Consecutive turns of a coil lying in a single plane.

Leaching and Non-Leaching: In a leaching wire, the plasticizer will migrate when exposed to heat. A non-leaching wire will retain its plasticizer under extreme temperature conditions and remain flexible after baking.

Lead: A wire, with or without terminals, that connects two points in a circuit.

Lead-Cured: A cable that is cured or vulcanized in a metallic lead mold.

Lead Dress: The placement or routing of wire and component leads in an electrical circuit.

Lead-in: The conductor or conductors that connect the antenna proper to electronic equipment.

Leakage Current: The undesirable flow of current through or over the surface of an insulation.

Life Cycle: A test to determine the length of time before failure in a controlled, usually accelerated, environment.

Light Commercial Building: A building or portion thereof that is intended for use with one to four (1-4) non-residential exchange access lines per tenant.

Light-Intensity Ratio: (fiber optic) Ratio of input light intensity to the output light intensity.

Light Source: (fiber optic) An object capable of emitting light. In fiber optics, the light source is normally an LED or a laser.

Lightguide: (fiber optic) A flexible bundle of fibers used to transmit light.

Lightwave Communications: (fiber optic) Communications using light to carry the information.

Limits of Error: The maximum deviation (in degrees of percent) of a thermocouple or thermocouple extension wire from standard emf-temperature to be measured.

Limpness: The ability of a cable to lay flat or conform to a surface.

Line Balance: The degree to which the conductors of a cable are alike in their electrical characteristics with respect to each other, to other conductors and to ground.

Line Drop: A voltage loss occurring between any two points in a transmission line, due to the resonance, reactance or leakage of the line.

Line Loss: The total of the various energy losses occurring in a transmission line.

Line Voltage: Voltage existing in a cable or circuit.

Link: An assembly of telecommunications facilities between two points, not including terminal equipment.

Glossary

- Listed:** Equipment included in a list published by an organization, acceptable to the authority having jurisdiction, that maintains periodic inspection of production of listed equipment, and whose listing states either that the equipment or material meets appropriate standards or has been tested and found suitable for use in a specified manner.
- Local Area Network (LAN):** A geographically limited communications network intended for the local transport of data, video and voice.
- Longitudinal Shield:** A tape shield, flat or corrugated, applied longitudinally with the axis of the core being shielded.
- Longitudinal Wrap:** Tape applied longitudinally with the axis of the core being covered.
- Loop Resistance:** The total resistance of two conductors measured round-trip from one end. Commonly used term in the thermocouple industry.
- Looping-in:** Wiring method which avoids tee joints by carrying the conductor or cable to and from the point to be supplied.
- Loss:** Energy dissipated without accomplishing useful work.
- Loss Factor:** The product of the dissipation and dielectric constant of an insulating material.
- Lossy Line:** A cable having large attenuation per unit of length.
- Low-Loss Dielectric:** An insulating material that has a relatively low dielectric loss, such as polyethylene or Teflon®.
- Low-Noise Cable:** Cable configuration specially constructed to eliminate spurious electrical disturbances caused by capacitance changes or self-generated noise induced by either physical abuse or adjacent circuitry.
- Low Tension:** Low voltage, as applied to ignition cable.
- Lug:** Termination, usually crimped or soldered to the conductor, with provision for screwing on to the terminal.
- m:** Meter.
- Magnet Wire:** Insulated wire intended for use in windings on motor, transformer and other coils for electromagnet devices.
- Magnetic Field:** The region within which a body or current experiences magnetic force.
- Magnetic Flux:** The rate of flow of magnetic energy across or through a surface (real or imaginary).
- Magnetic Noise:** Caused by change in current level, e.g. ac powerline (creates magnetic field around the cable) this magnetic field causes the magnetic noise.
- Main Cross-Connect:** A cross-connect for 1st level backbone cables, entrance cables and equipment cables.
- Marker Tape:** A tape laid parallel to the conductors under the sheath in a cable, imprinted with the manufacturer's name and the specification to which the cable is made.
- Master Antenna Television (MATV):** A combination of components providing multiple television receiver operations from one antenna or group of antennas normally on a single building.
- Material Scattering Loss:** (fiber optics) Loss due to fluctuations in the refractive index and to inhomogeneities in material composition and temperature.
- Media, Telecommunications:** Wire, cable or conductors used for telecommunications.
- Megarad:** A unit for measuring radiation dosage.
- Messenger:** Supporting member, usually a high-strength steel wire, used to suspend aerial cable. The messenger may be an integral part of the cable, or exterior to it (lashed messenger).
- Microbending Loss:** (fiber optic) Loss due to small geometrical irregularities along the core-clad interface of the fiber.
- Microfarad:** One-millionth of a farad, commonly abbreviated m-F.
- Micromicrofarad:** One-millionth of a microfarad. (uuf, uufd, mmf, mmfd m-m F are common abbreviations.)
- Microwave:** A short (usually less than 30 cm.) electrical wave.
- Mil:** A unit used in measuring diameter of a wire or thickness of insulation over a conductor. One-one thousandth of an inch (.001").
- Mineral-Insulated:** Cable and thermocouple wire consisting of one or more conductors surrounded by magnesium oxide insulation and enclosed in a liquid- and gas-tight metallic sheathing.
- Miniature Wire:** Insulated conductors of approximately 20-34 AWG.
- Mis-Match:** A termination having a different impedance than that for which a circuit or cable is designed.
- Mode:** One of the components of a general configuration of a propagating wave front.
- Modem:** Device which places and receives data signals over a common carrier's communication facility.
- Modular Jack:** This term is outmoded; see Outlet/Connector, Telecommunications.
- Modular Plug:** A telecommunications connector for wire or cords per the Part 68 Rules. A modular plug can have 6 or 8 contact positions, but not all the positions need be equipped with contacts.
- Modulation:** A process whereby certain characteristics of a wave, often called the carrier, are varied or selected in accordance with a modulating function.
- Modulus of Elasticity:** The ratio of stress to strain in an elastic material.
- Moisture Absorption:** The amount of moisture, in percentage, that a material will absorb under specified conditions.
- Moisture Resistance:** The ability of a material to resist absorbing moisture from the air or when immersed in water.
- Molded Plug:** A connector molded on either end of a cord or cable.
- Monomer:** The basic chemical unit used in building a polymer.
- Motor Lead Wire:** Wire which connects to the fragile magnet wire found in coils, transformers and stator or field windings.
- Multiconductor:** More than one conductor within a single cable complex.
- Multimode Optical Fiber:** An optical fiber that will allow many bound modes to propagate. The fiber may be either a graded-index or step-index fiber. See also: Optical Fiber Cable.
- Multiple Conductor Cable:** A combination of two or more conductors cabled together and insulated from one another and from sheath or armor where used.
- Multiple Conductor Concentric Cable:** An insulated central conductor with one or more tubular stranded conductors laid over it concentrically and insulated from one another.
- Multiplexing:** Simultaneous transmission of two or more messages over the same cable pair.
- Mutual Capacitance:** Capacitance between two conductors when all other conductors are connected together to shield and ground.
- Mylar®:** DuPont trademark for polyester film.
- Nanometer (nm):** One billionth of a meter (10^{-9} meter).
- Nanosecond:** One billionth of a second (10^{-9} seconds).
- National Electric Code (NEC):** A set of regulations governing construction and installation of electrical wiring and apparatus in the United States, established by the American National Board of Fire Underwriters.
- Neoprene:** A synthetic rubber with good resistance to oil, chemical and flame. Also called polychloroprene.
- Noise:** In a cable or circuit, any extraneous signal which tends to interfere with the signal normally present in or passing through the system.
- Nomex®:** DuPont trademark for a temperature-resistant, flame-retardant nylon.
- Non-Contaminating:** Type of PVC jacket material whose plasticizer will not migrate into the dielectric of a coaxial cable and thus avoids contaminating and destroying the dielectric.
- Nylon:** Thermoplastic with good chemical and abrasion resistance.
- NVP:** Nominal Velocity of Propagation.
- Off Center:** Conductor displaced within the cross-section of its insulation.
- Offgassing:** Percentage of a specified gas released during the combustion of insulation or jacketing material.
- Ohm:** A unit of electrical resistance.
- Oil Aging:** Cable aged in an accelerated manner by placement in an oil bath and heated to a pre-set temperature for a stated time.
- Oil-Filled Cable:** A self-contained pressure cable in which the pressure medium is low viscosity oil having access to the insulation.
- Opaque:** (fiber optic) Not permitting the passage of light.
- Open Cell:** Foamed or cellular material with cells which are generally interconnected.
- Optical Communication Cable:** (fiber optic) Fiber with a protective jacket around it.
- Optical Conductors:** (fiber optic) Materials which offer a low optical attenuation to transmission of light energy.
- Optical Fiber Cable:** An assembly consisting of one or more optical fibers.
- Optical Fiber Duplex Adapter:** A mechanical media termination device designed to align and join two duplex connectors.
- Optical Fiber Duplex Connector:** A mechanical media termination device designed to transfer optical power between two pairs of optical fibers.
- Optical Waveguide:** (fiber optic) A fiber used for optical communications. Analogous to a waveguide used for microwave communications.
- Oscillatory Surge:** A surge which includes both positive and negative polarity values.
- Outgassing:** The dissipation of gas from a dielectric evidencing decomposition.
- Outlet Box, Telecommunications:** A metallic or nonmetallic box mounted within a wall, floor or ceiling and used to hold telecommunications outlet/connectors or transition devices.

Glossary

Outlet/Connector, Telecommunications: A connecting device in the work area on which horizontal cable terminates.

Overall Diameter: Finished diameter over wire or cable.

Overcoat Conductor: A stranded conductor made from individual strands of tin-coated wire stranded together, and then given an overall tin coat.

Overlap: The amount the trailing edge laps over the leading edge of a spiral tape wrap.

Oxygen Index: Percentage of oxygen necessary to support combustion in a gas mixture.

Ozone: Reactive form of oxygen, typically found around electrical discharges and present in the atmosphere in small quantities.

Packing Fraction: (fiber optic) The ratio of active cross-sectional area of fiber core, or cores, to the total end surface of the fiber, or fiber bundle.

Pair: Two insulated wires of a single circuit associated together, also known as a "balance" transmission line.

Parallel Pair: A duplex construction of two insulated conductors laid parallel and then covered overall with a braid or jacket.

Parallel Stripe: A stripe applied longitudinally on a wire or cable parallel to the axis of the conductor.

Patch Cord: A length of cable with connectors on one or both ends used to join telecommunications links/circuits at the cross-connect.

Patch Cord Cable: Bulk cable used in the manufacture of patch cords.

Patch Panel: A cross-connect system of mateable connectors that facilitates administration.

Pathway: A facility for the placement of telecommunications cable. Synonym: Raceway.

Pay-Off: The process of feeding a cable or wire from a bobbin, reel or other package.

Percent Plating: Quantity of plating on a conductor expressed as a percentage by weight.

Percentage Conductivity: Conductivity of a material expressed as a percentage of that of copper.

Periodicity: The uniformly spaced variations in the insulation diameter of a transmission cable that result in reflections of a signal, when its wavelength or a multiple thereof is equal to the distance between two diameter variations.

Permittivity: See Dielectric Constant.

Phase: An angular relationship between waves.

Phase Shift: A change in the phase relationship between two alternating quantities.

Photodetector (Receiver): Converts light energy to electrical energy.

Pick: Distance between two adjacent crossover points of braid filaments. The measurement in picks per inch indicates the degree of coverage.

Picofarad: One-millionth of one-millionth of a farad. A micromicrofarad or picofarad (abbreviation pf). (See mm F).

Pigtail Wire: Fine-stranded, extra-flexible, rope-lay lead wire attached to a shield for terminating purposes.

Pitch: In flat cable, the nominal distance between the index edges of two adjacent conductors.

Pitch Diameter: Diameter of a circle passing through the center of the conductors in any layer of a multiconductor cable.

Plain Conductor: A conductor consisting of only one metal.

Plain Weave: A weave used on woven cables. Threads between the wires act as binders and give the cable lateral stiffness and linear flexibility. Also called Standard and Square Weave.

Planetary Cabling: A cabling capable of laying down any number of shielded, overbraided or jacketed singles, pairs, called groups, or any combination of them in sequence.

Planetary Twister: A twisting machine whose payoff spools are mounted in rotating cradles that hold the axis of the spool in a fixed direction as the spools are revolved so no twist is built up in each wire.

Plastic Deformation: Change in dimensions under load that is not recovered when the load is removed.

Plasticizer: A chemical agent added to plastics to make them softer and more pliable.

Plenum: The air return path of a central air handling system, either ductwork or open space over a suspended ceiling.

Plenum Cable: Cable approved by a recognized agency such as UL for installation in plenums without the need for conduit.

Plug: The part of the two mating halves of a connector which is moveable when not fastened to the other mating half.

Ply: The number of individual strands or filaments twisted together to form a single thread.

Point-to-Point: A type of connection established between two specific locations, as between two buildings.

Point-to-Point Wiring: An interconnecting technique wherein the connections between components are made by wires routed between connecting points.

Polarization: The orientation of a flat cable or a rectangular connector.

Polishing: (fiber optic) Act of smoothing ends of fibers to an 'optically smooth' finish, generally using abrasive.

Polyester: Polyethylene terephthalate, used extensively as a moisture-resistant cable core wrap.

Polyethylene: A thermoplastic material having excellent electrical properties.

Polyhalocarbon: A general name for polymers containing halogen atoms. The halogens are fluorine, chlorine, bromine and iodine.

Polymer: A material of high molecular weight formed by the chemical union of monomers.

Polyolefin: Any of the polymers and copolymers of the ethylene family of hydrocarbons.

Polypropylene: A thermoplastic similar to polyethylene but stiffer and having higher softening point (temperature); excellent electrical properties.

Polyurethane: Class of polymers known for good abrasion and solvent resistance (may be applied in solid or cellular form).

Porosity: Multiple voids in an insulation cross-section.

Potting: The sealing of a cable termination or other component with a liquid which thermosets into an elastomer.

Power Cables: Cables of various sizes, construction and insulation, single or multi-conductor designed to distribute primary power to various types of equipment.

Power Factor: The ratio of resistance to impedance. The ratio of the actual power of an alternating current to apparent power. Mathematically, the cosine of the angle between the voltage applied and the current resulting.

Pre-Bond: Stranded wire which has been fused, topcoat-tinned or overcoat-tinned.

Prewiring: Wiring installed

- Before walls are enclosed or finished.
- In anticipation of future use or need.

Primary: The transformer winding which receives the energy from a supply circuit.

Primary Insulation: The first layer of non-conductive material applied over a conductor, whose prime function is to act as electrical insulation.

Primary Protection: The minimum protection required on all exposed facilities to comply with NEC requirements.

Primary Wiring: A printed circuit intended to provide point-to-point electrical connections.

Programming: Ability to select various circuit patterns by interconnecting appropriate contacts on one side of a connector plug or panel.

Propagation Delay: Time delay between input and output of signal.

Propagation Time: Time required for a wave to travel between two points on a transmission line.

Protocol: A set of rules for communicating.

Proximity Effect: Nonuniform current distribution over the cross-section of a conductor caused by the variation of the current in a neighboring conductor.

Pull Box: A device to access a raceway used to facilitate placing of wire or cables.

Pull Cord/Pull Wire: Cord or wire placed within a raceway and used to pull wire and cable through the raceway.

Pull Strength: See Pull Tension.

Pull Tension: The maximum pulling force that can be safely applied to a cable without damage.

Pulling Eye: A device used to pull cable into or from a duct.

Pulse: Energy which changes abruptly from an intensity to another. May be light energy or electrical energy.

Pulse Cable: A type of coaxial cable constructed to transmit repeated high-voltage pulses without degradation.

Polyvinyl Chloride (PVC): A general-purpose thermoplastic widely used for wire and cable insulations and jackets.

Quad: A series of four separately insulated conductors, generally twisted together in pairs. Also, a series-parallel combination of transistors with increased reliability because failure of one transistor will not disable the entire circuit.

Quadders: Three-bay machines which can twist four wires together and cable braided and shielded wires with varying lay lengths.

Raceway: Any channel designed for holding wires or cables, e.g. conduit, electrical metallic tubing, sleeves, slots, underfloor raceways, cellular floors, surface raceways, lighting fixture raceways, wireways, cable troughs, busways, auxiliary gutters and ventilated flexible cableways. Synonym: Pathway.

Rack: See: Cable Rack.

Radio Frequency: The frequencies in the electromagnetic spectrum that are used for radio communications.



Glossary

- Random Winding:** A winding in rotating equipment wherein the wires do not lie in an even pattern.
- Reactance:** The opposition offered to the flow of alternating current by inductance or capacitance of a compound or circuit.
- Red Plaque:** A powdery, brown-red growth found on silvercoated copper conductors and shield braids.
- Redraw:** The consecutive drawing of wire through a series of dies to reach a desired wire size.
- Reducing Joint:** A joint between two lengths of cable where the conductors are not the same size.
- Reel:** A revolvable flanged device made of wood or metal, used for winding flexible metal wire or cable.
- Reflection:** (fiber optic) Change in direction of a light wave or ray.
- Reflection Loss:** The part of a signal which is lost due to reflection of power at a line discontinuity.
- Refraction:** (fiber optic) The bending of lightwaves or rays as they go from one material to another due to the difference in velocities in the materials.
- Reinforced Sheath:** The outermost covering of a cable that has cable sheath constructed in layers with the addition of a reinforcing material, usually a braided fiber, molded in place between layers.
- Remanence:** The magnetic induction that remains in a magnetic circuit after the removal of an applied magnetomotive force.
- Repeater:** A device which consists of a transmitter and a receiver or transmitter, used to regenerate a signal to increase the system transmission length.
- Resistance:** A measure of the difficulty in moving electrical current through a medium when voltage is applied. It is measured in Ω .
- Resistive Conductor:** A conductor with high electric resistance.
- Retractile Cord:** A cord having specially treated insulation or jacket so that it will retract.
- Return Wire:** A ground wire or the negative wire in a direct-current circuit.
- Ribbon Cable:** A flat cable of individually insulated conductors lying parallel and held together by means of adhesive or woven textile yarn.
- Ridge Marker:** One or more ridges running laterally along the outer surface of a plastic-insulated wire for purposes of identification.
- Rigid Bay:** Cabling equipment that maintains component sequence, and can produce cables with distinct layers.
- Rigid Coaxial Cable:** Nonflexible coaxial cable, usually a metal tube armored coaxial cable.
- Ring Tongue:** A solderless terminal that connects wire to a stud.
- Ring Out:** Locating or identifying specific conductive paths by passing current through selected conductors.
- Rip-Cord:** 1.) Two or more insulated conductors in a parallel configuration which may be separated to leave the insulation of each conductor intact. 2.) A small filament cord used to rip through the outer cable sheath.
- RoHS (Restriction on Hazardous Substances):** European Union directive that restricts use of heavy metal substances.
- Rope Concentric:** A group of standard conductors assembled in a concentric manner.
- Rope Lay Conductor:** A conductor composed of a central core surrounded by one or more layers of helically laid groups of wires.
- Rope Unilay:** A group of stranded conductors assembled in a unilay manner.
- Round Wire Shields:** Shields constructed from bare, tinned or silver-plated copper wire that include braided, spiral and reverse spiral.
- Routers:** A device that determines how to forward a packet toward its destination, based on tables that indicate the costs, congestion status and other factors associated with possible routes. Also called a level 3 relay or an intermediate system.
- Rubber (Wire Insulation):** Term used to describe wire insulations made of thermosetting elastomers; occurs naturally or may be made synthetically.
- Rulan®:** DuPont's trade name for their flame-retardant polyethylene insulating material.
- Screen:** A shield placed over the entire core.
- Secondary Insulation:** A nonconductive material that protects the conductor against abrasion and provides a second electrical barrier.
- Segmental Conductor:** A stranded conductor consisting of three or more stranded conducting elements, each element having approximately the shape of the sector of a circle, assembled to give a substantially circular cross-section.
- Selenium Cure:** Process used to cure neoprene and rubber jacketed wires and cables.
- Self-Extinguishing:** Characteristic of a material whose flame is extinguished after the igniting flame source is removed.
- Semi-Conducting Jacket:** A jacket having a sufficiently low resistance so that its outer surface can be kept at substantially ground potential.
- Semi-Rigid:** A cable containing a flexible inner core and a relatively inflexible sheathing.
- Semi-Solid:** An insulation cross-section having a partially open space between the conductor and the insulation perimeter.
- Separator:** A layer of insulating material which is placed between a conductor and its dielectric between a cable jacket and the components it covers, or between various components of a multiple-conductor cable.
- Series Circuit:** A circuit in which the components are arranged end to end to form a single path for current.
- Serve:** A filament or group of filaments such as fibers or wires, wound around a central core.
- Servicing:** A wrapping applied over the core of a cable or over a wire.
- Sheath:** See Cable Sheath.
- Shield:** In cables, a metallic layer placed around a conductor or group of conductors to prevent electrostatic or electromagnetic interference between the enclosed wires or external fields.
- Shield Coverage:** Amount of outer cable covered by the shielding material.
- Shield Effectiveness:** The ability of a shield to screen out undesirable signals.
- Shielded Line:** A transmission line whose elements confine propagated radio waves to an essentially finite space inside a tubular conducting surface called the sheath, thus preventing the line from radiating radio waves.
- Shielded-Type Cable:** A cable in which the surface of the insulation is at ground potential.
- Shunt Wire:** A conductor joining two parts of an electric circuit to divert part of the current.
- Signal:** A current used to convey information, either digital, analog, audio or video.
- Silicone:** A material made from silicon and oxygen. Can be in thermosetting elastomer or liquid form. The thermosetting elastomer form is noted for high heat resistance.
- Silicone Treating:** A silicone liquid treatment applied to insulated conductors to allow for easy jacket stripping.
- Sine Wave:** A wave that can be expressed as the sine of a linear function of time, or space or both.
- Single-ended:** Unbalanced, such as grounding one side of a circuit or transmission line.
- Single-Faced Tape:** Fabric tape finished on one side with a rubber or synthetic compound.
- Singlemode Fiber:** A fiber wave guide in which only one mode will propagate. The fiber has a very small core diameter of approximately 8mm. It permits signal transmission at extremely high bandwidths and is generally used with laser diodes.
- Sizing:** Applying a material to a surface to fill pores.
- Skeleton Braid:** Widely separated braid of fiber copper or steel, used to hold core together, for reinforcing jacket or for shielding.
- Skew Rays:** A ray that does not intersect the fiber axis. Generally, a light ray that enters the fiber core at a very high angle.
- Skim Tape:** Filled tape coated on one or both sides with a thin film of uncured rubber or synthetic compound to produce a coating suitable for vulcanization.
- Skin Effect:** The tendency of alternating current, as its frequency increases, to travel only on the surface of a conductor.
- Sleeve:** A braided, knitted or woven tube used over wires or components as insulation tubing. Also called Sleeving.
- Solid Conductor:** A conductor consisting of a single wire.
- Source Coupling Loss:** (fiber optic) Loss of light intensity as light from source passes into fiber.
- Space, Telecommunications:** An area used for housing the installation and termination of telecommunications equipment and cable, e.g. telecommunications closets, work areas and manhole/handholes.
- Span:** (1.) In flat conductors, distance between the reference edge of the first and the last conductor. (2.) In round conductors, distance between centers of the first and last conductors. (3.) In aerial cable, the distance between poles or support clamps.
- Spark Test:** A test designed to locate pin-holes in the insulation of a wire or cable by application of a voltage for a very short period of time while the wire is being drawn through the electrode field.
- Specific Gravity:** The ratio of the density (mass per unit volume) of a material to that of water.
- Spectral Bandwidth:** The difference between wavelengths at which the radiant intensity of illumination is half its peak intensity.
- Spectral Response:** (fiber optic) The response of a detector (or a system) over different wavelengths.
- Spectrum:** Frequencies that exist in a continuous range and have a common characteristic.
- Speed of Light (c):** 2.998×10^8 meters per second.
- Spiral Shield:** A metallic shield of fine-stranded wires applied spirally rather than braided.

Glossary

Spiral Stripe: A color-coding stripe applied helically to the surface of an insulated wire or cable.

Spiral Wrap: The helical wrap of a tape or thread over a core.

Splice: A joining of conductors, generally from separate sheaths.

Splice Closure: A device used to protect a cable or wire splice.

Spread Spectrum: A modulation technique for multiple access, or for increasing immunity to noise and interference.

Standing Wave: The stationary pattern of waves produced by two waves of the same frequency traveling in opposite directions on the same transmission line.

Standing Wave Ratio (SWR): In a transmission line, waveguide, or analogous system, a figure of merit used to express the efficiency of the system in transmitting power.

Star Topology: A topology in which each telecommunications outlet/connector is directly cabled to the distribution device.

Stay Cord: A component of a cable used to anchor the cable ends at their points of termination and to keep any pull of the cable from being transferred to the electrical connections.

Step Index Fiber: (fiber optic) A multimode fiber consisting of a core of uniform refractive index surrounded by cladding of slightly lower refractive index.

Strand: One of the wires of any stranded conductor.

Strand Lay: The distance of advance of one strand of a spirally stranded conductor, in one turn, measured axially.

Stranded Conductor: A conductor composed of groups of wires twisted together.

Strap: Square- or rectangular-section bare conductor manufactured and used in coil form.

Strip: To remove insulation from a cable.

Structural Return Loss: Backward reflected energies from uneven parts of the cable structure causing impedance variations are termed structural return loss.

Surface Resistivity: The resistance of a material between two opposite sides of a unit square of its surface. It is usually expressed in Ω .

Surge: A temporary and relatively large increase in the voltage or current in an electric circuit or cable. Also called Transient.

Suspended Ceiling: See False Ceiling.

Sweep-test: Pertaining to cable, the frequency response is verified by generating an rf voltage whose frequency is swept repeatedly through a given frequency range at a rapid constant rate while the cable response is observed.

Take-Up: The process of accumulating wire or cable onto a reel, bobbin or some other type of pack. Also, the device for pulling wire or cable through a piece of equipment or machine.

Tank Test: A voltage dielectric test in which the test sample is submerged in water and voltage is applied between the conductor and water as ground.

Tape: A relatively narrow woven or cut strip of fabric, paper or film material.

Tape Cable: A form of multiple conductor consisting of parallel metal strips imbedded in insulating material.

Tape Wrap: A spirally applied tape over an insulated or uninsulated wire.

Taped Insulation: Insulation of helically wound tapes applied over a conductor or over an assembled group of insulated conductors.

Taping: Process of insulating continuous length, large diameter wires with tape of non-extrudable materials.

TB: Terminal Block

Tear Strength: The force required to initiate or continue a tear in a material under specified conditions.

Teflon®: DuPont company trade name for fluorocarbon resins. FEP, PFA and TFE are typical materials.

Tefzel®: DuPont trade name for a fluorocarbon material typically used as a wire wrap insulation.

Telecommunications: The communication of information over some distance, including interbuilding and intrabuilding distances.

Telecommunications Closet: See Closet, Telecommunications.

Telecommunications Entrance Facility: See Entrance Facility, Telecommunications.

Telecommunications Entrance Point: See Entrance Point, Telecommunications.

Telecommunications Entrance Room or Space: See Entrance Room or Space, Telecommunications.

Telecommunications Equipment Room: See Equipment Room, Telecommunications.

Telecommunications Grounding Busbar: A common point of connection for telecommunications system and bonding to ground, which is located in the telecommunications closet or equipment room.

Telecommunications Infrastructure: See Infrastructure, Telecommunications.

Telecommunications Outlet/Connector: See Outlet/Connector, Telecommunications.

Telemetry Cable: Cable used for transmission of information from instruments to the peripheral recording equipment.

Temperature Rating: The maximum temperature at which an insulating material may be used in continuous operation without loss of its basic properties.

Tensile Strength: The pull stress required to break a given specimen.

Tension Member: A member included in a fiber cable to add tensile strength.

Terminal: (1) A point at which information may enter or leave a communications network; (2) the input-output associated equipment; or (3) a device by means of which wires may be connected to each other.

Termination Hardware: This term is outmoded. See Connecting Hardware.

Test Lead: A flexible, insulated lead wire used for making tests, connecting instruments to a circuit temporarily or for making temporary electrical connections.

Textile Braid: Any braid made from threads of cotton silk, or synthetic fibers.

Thermal Aging: Exposure to a thermal condition or programmed series of conditions for prescribed periods of time.

Thermocouple Lead Wire: An insulated pair of wires used from the couple to a junction box.

Thermoplastic: A material which softens when heated and becomes firm on cooling.

Thermoset: A material which hardens or sets when heat is applied, and which, once set, cannot be resoftened by heating. The application of heat is called "curing."

Three-Phase Current: Current delivered through three wires, with each wire serving as a return for the other two.

Three-Phase Three-Wire System: An alternating current supply system comprising three conductors over which three-phase power is sent.

Three-Wire System: A d-c or single-phase a-c system comprising three conductors, one of which is maintained at a potential midway between the potential of the other two.

Tin Overcoat (TOC): Tinned copper wire, stranded, then coated with pure tin.

Tinsel Wire: A low-voltage stranded wire, with each strand a very thin conductor ribbon spirally wrapped around a textile yarn.

Topcoat: Bare (untinned) copper wire, stranded then coated with pure tin.

Topology: The physical or logical arrangement of a telecommunications system.

Tracer: A means of identifying polarity.

Transducer: A device for converting mechanical energy to electrical energy.

Transfer Impedance: The ratio of the source voltage of the wires inside the cable to the shield current of the cable or connectorized cable assembly.

Transition Point: A location in the horizontal cabling where flat undercarpet cable connects to round cable.

Transmission: Transfer of electric energy from one location to another through conductors or by radiation or induction fields.

Transmission Cable: Two or more transmission lines. See Transmission Line.

Transmission Line: An arrangement of two or more conductors or a wave guide used to transfer signal energy from one location to another.

Transmission Loss: The decrease or loss in power during transmission of energy from one point to another. Usually expressed in decibels.

Transmission Media: The various types of wire and optical fiber cable used for transmitting voice or data signals. Typically, wire cable includes twisted pair, coaxial and twinaxial. Optical fiber cable includes single, dual, quad, stranded and ribbon (AI).

Transmitter: The electronic package that injects an electrical signal or light signal over the transmission medium.

Transparent: (fiber optic) Transmitting rays of light so that objects can be seen through the material.

Transposition: Interchanging the relative positions of wires to neutralize the effects of induction to or from other circuits or, to minimize interference pickup by the lead-in during reception.

Tray Cable: A factory-assembled multiconductor or multipair control cable approved under the National Electrical Code for installation in trays.

Triaxial: A three-conductor cable with one conductor in the center, a second circular conductor shield concentric with the first, and third circular conductor shield insulated from and concentric with the first and second, usually with insulation, and over a braid or impervious sheath overall.

Triboelectric Noise: Noise generated in a shielded cable due to variations in capacitance between shielding and conductor as the cable is flexed.

Glossary

Triple Cable: A cable composed of three insulated single conductors and one bare conductor, all twisted together. It may or may not have a common covering of binding.

True Concentric: A cable in which each successive layer has a reversed direction of lay from the preceding layer.

Trunk Cable: See Feeder Cable.

Tubing: A tube of extruded non-supported plastic material.

Twin Cable: A pair of insulated conductors twisted, sheathed or held together mechanically and not identifiable from each other in a common covering.

Twin Coaxial: A configuration containing two separate, complete coaxial cables laid parallel or twisted around each other in one complex.

Twin Line: A transmission line which has a solid insulating material, in which the two conductors are placed in parallel to each other.

Twiner: A device for twisting together two conductors.

Twisted Pairs: A cable composed of two small insulated conductors twisted together without a common covering.

Unbalanced Line: A transmission line in which voltages on the two conductors are unequal with respect to ground.

Unidirectional Concentric Stranding: A stranding where each successive layer has a different lay length, thereby retaining a circular form without migration of strands from one layer to another.

Unidirectional Stranding: A term denoting that in a stranded conductor, all layers have the same direction of lay.

Unilay Strand: A conductor constructed with a central core surrounded by more than one layer of helically-laid wires, with all layers having a common length and direction of lay.

Velocity of Propagation (VP): The speed of an electrical signal down a length of cable compared to speed in free space expressed as a percent. It is the reciprocal of the square root of the dielectric constant of the cable insulation.

Volt: A unit of electromotive force.

Voltage: The term most often used in place of electromotive force, potential difference or voltage drop to designate the electric pressure that exists between two points and is capable of producing a current when a closed circuit is connected between two points.

Voltage Drop: The voltage developed across a component or conductor by the current in the resistance or impedance of the component or conductor.

Voltage Rating: The highest voltage that may be continuously applied to a wire in conformance with standards or specifications.

Voltage Standing Wave Ratio (VSWR): The ratio of the maximum effective voltage to the minimum effective voltage measured along the length of a mis-matched radio frequency transmission line.

Volume Resistivity (Specific Insulation Resistance): The electrical resistance between opposite faces of a 1 cm. cube of insulating material, commonly expressed in Ω /centimeter.

Vulcanization: A chemical reaction in which the physical properties of an elastomer are changed by reacting it with sulfur or other cross-linking agents.

Wall Thickness: The thickness of the applied insulation or jacket.

Water Absorption: A test to determine the water absorbed by a material after a given immersion period.

Waterblocked Cable: A cable constructed with no internal voids in order to allow no longitudinal water passage under a given pressure.

Watt: A unit of electric power.

Wave Form: A graphical representation of a varying quantity. Usually, time is represented on the horizontal axis, and the current or voltage value is represented on the vertical axis.

Wave Length: The distance, measured in the direction of propagation, of a repetitive electrical pulse or waveform between two successive points that are characterized by the same phase of vibration.

Wicking: The longitudinal flow of a liquid in a wire or cable due to capillary action.

Wire: A conductor, either bare or insulated.

Wire and Cable Marker: Device for identification marking of wire and cable.

Wire and Cable Tying, Clamping, and Harnessing Devices: Tying tapes, lacing cords and flexible sleeveings which are used for wire and cable bundling, harnessing and holding. Other devices include plastic ties or clamps, spiral-cut plastic tubing and plastic U-shaped trays or ducts.

Wire and Lead Cutters: Tools for cutting that range from plier-type cutters to semiautomatic or fully automatic machines integrated with other wire processing operations such as stripping, forming and terminating.

Wire Gauge: A system of numerical designation of wire sizes.

Wire Nut: A closed-end splice that is screwed on instead of crimped.

Wire Wrapped Connection: A solderless connection made by wrapping bare wire around a square or rectangular terminal with a power or hand tool.

Wire Wrapping Tools: Portable electric tools and automatic stationary machines used to make solderless wrapped connections of wires to terminals.

Wiring Closet: See Telecommunications Closet.

Work Area (Work Station): A building space where the occupants interact with telecommunications terminal equipment.

Wrapper: An insulating barrier applied as a sheet or tape wrapped around a coil periphery.

Yield Strength: The minimum stress at which a material will start to physically deform without increase in load.

Zytel®: DuPont's trade name for nylon resins.

Sections of this glossary are reprinted with permission from December, 1985 Issue of ELECTRONICS copyright 1985. Lake Publishing Corporation, 17730 W. Peterson Rd., Libertyville, IL 60048-0159 USA. Permission to reprint granted to the Prysmian Corporation. No additional reproduction of this wire and cable glossary allowed without written permission.

Abbreviations & Acronyms

A-D: Analog to digital conversion	CEBEC: Belgium approval agency; Commitee Electrotechnique Belge Service de la Marque	DGM: Data Grade Medium
ac: Alternating current	CEE: European standards agency; International Commission on Rules for the Approval of Electrical Equipment	DISA: Defense Information Systems Agency (formerly DCA)
AC: Armored Cable, NEC Article 333 Cable Designation	CEN: European Committee for Standardization	DISI: Directory Information Services Infrastructure
ACO: Analog Central Office	CENELEC: European Committee for Electrotechnical Standardization	DIST: District
ACR: Attenuation to Crosstalk Ratio	CFC: Communications Flat Cable	DRT: Plastic range and dryer cord (CSA)
ADO: Auxiliary Disconnect Outlet	ckt: Circuit	DTE: Data Terminal Equipment
AER: Aerial	CLT or CLOS: Closet	DVD: Digital Versatile Disc
AF: Audio frequency	CL2: Class 2 Circuit Cable, NEC Article 725 Cable Designation	DW: Distribution Wire
AIA: American Institute of Architects	CL2P: Class 2 Circuit Plenum Cable, NEC Article 725 Cable Designation	E: Symbol for voltage. Usually used to represent direct voltage or the effective (root-mean-square) value of an alternating voltage
ALPETH: An aerial telephone cable having an aluminum shield and polyethylene jacket	CL2R: Class 2 Circuit Riser Cable, NEC Article 725 Cable Designation	EFTS: Electronic funds transfer system
ALS: A type of cable consisting of insulated conductors enclosed in a continuous, closely fitting aluminum tube	CL2X: Class 2 Circuit Limited Use Cable, NEC Article 725 Cable Designation	EIA: Electronic Industries Association
ALVYN: An indoor, riser rated telephone cable having an aluminum shield and vinyl jacket (PVC)	CL3: Class 3 Circuit Cable, NEC Article 725 Cable Designation	EMF: Electromotive Force
AM: Amplitude Modulation	CL3P: Class 3 Circuit Plenum Cable, NEC Article 725 Cable Designation	EMI: Electromagnetic Interference
ANSI: American National Standards Institute	CL3R: Class 3 Circuit Riser Cable, NEC Article 725 Cable Designation	EMT: Electric Metallic Tubing
ARPANET: Advanced Research Projects Agency Network	CL3X: Class 3 Circuit Limited Use Cable, NEC Article 725 Cable Designation	EP: Entrance point
ASCII: American Standard Code for Information Interchange	CM: Communications Cable, NEC Article 800 Cable Designation	EPDM: Ethylene-propylene-diene monomer rubber
ASME: American Society of Mechanical Engineers	CMA: Circular Mil Area	EPOS: Electronic Point-Of-Sale
ASP: A filled, direct burial telephone cable used in areas subject to rodent attack. It consists of a filled cable core, corrugated aluminum shield, corrugated steel tape, flooding compound and polyethylene jacket.	CMP: Communication Cable Plenum, NEC Article 800 Cable Designation	EPR: Ethylene-propylene rubber
ASTA: United Kingdom approval agency	CMR: Communications Cable Riser, NEC Article 800 Cable Designation	ER: Equipment room
ASTM: American Society for Testing and Materials	CMX: Communications Limited Use Cable, NEC Article 800 Cable Designation	ESS: Electronic Switching System
AWG: American Wire Gauge	CO: Central Office	ESTA: Australian approval agency; Electricity Trust of South Australia
AWM: Appliance wiring material	codec: Coder decoder	ETPC: Electrolytic Tough Pitch Copper
B & S Gauge: See American Wire Gauge (AWG)	COE: Central Office Equipment	ETV: Educational Television
B or BUR: Buried	COS: Cooperation for Open Systems	E/W: Equipped With
AWM: Appliance wiring material	COSINE: Cooperation for Open Systems Interconnection Network in Europe	EX or EXT: Extension
BCF: Billion Conductor Feet	COT: Central Office Terminal	EXCH: Exchange
BEF: Building Entrance Facility	CPC: Customer Premises Communication	f: Frequency
BER: Bit Error Rate	CPE: (1) Chlorinated Polyethylene (2) Customer Premises Equipment or Customer Provided Equipment	FAA: Federal Aeronautics Administration
BIC: Building Industry Consultant	CPU: Central Processing Unit	FCC: (1) Federal Communications Commission (2) Flat Conductor Cable, NEC Article 328 Cable Designation
BICSI: Building Industry Consulting Service International	CRT: Cathode Ray Tube	FDDI: Fiber Distributed Data Interface
BISDN: Broadband Integrated Services Digital Network	CSMA/CD: Carrier Sense Multiple Access/ Collision Detection	FDM: Frequency-Division Multiplexing
BTU: British Thermal Unit	CSPE: Chlorosulfonated Polyethylene	FDR: Feeder
CA: Cable	CTR: Certified Test Report	FEP: Fluorinated ethylene propylene
CATV: (1) Community Antenna Television; Cable Access Television (2) CATV Cable, NEC Article 820 Cable Designation	CV: Continuous vulcanization	FEXT: Far End Crosstalk
CATVP: CATV Plenum Cable, NEC Article 820 Cable Designation	D-A: Digital to analog conversion	FI: Approval agency of Finland; Electrical Inspectorate
CATVR: CATV Riser Cable, NEC Article 820 Cable Designation	DAF: Dedicated Access Facility	FIPS PUB: Federal Information Processing Standard Publication
CATVX: CATV Limited Use Cable, NEC Article 820 Cable Designation	dB: Decibel	FM: Frequency modulation
CB: Citizens band	DBS: Direct Broadcast Satellite	FOCIS: Fiber Optic Connector Intermateability Standard
C-C: Conductor to conductor capacitance	dc: Direct current	FOTP: Fiber Optic Test Procedure
CCITT: The International Telegraph and Telephone Consultative Committee	DCE: Data Circuit-Terminating Equipment	FOTS: Fiber Optics Transmission System
CCTV: Closed-circuit television	DCO: Digital Central Office	FPL: Power Limited Fire Protective Signaling Circuit Cable, NEC Article 760 Cable Designation
CDDI: Copper Distributed Data Interface	DCR: Direct Current Resistance	FPLP: Power Limited Fire Protective Signaling Circuit Plenum Cable, NEC Article 760 Cable Designation
CDF: Central Distribution Frame	DD: Distribution Designer or Distribution Device	FPLR: Power Limited Fire Protective Signaling Circuit Riser Cable, NEC Article 760 Cable Designation
CDO: Community Dial Office	DEMARC: Demarcation point	FR-1: A flammability rating established by Underwriter's Laboratories for wires and cables that pass a specially designed vertical flame test
	DEMKO: Approval agency of Denmark	freq: Frequency
		FRICC: Federal Research Internet Coordinating Committee (now FNC)

Abbreviations & Acronyms

FRPE: Flame Retardant Polyethylene	kHz: Kilohertz	NEXT: Near End Crosstalk
ft: Foot	Kilo: A numerical prefix denoting 1000 (10 ³)	nf: Nanofarad
FTP: Fire Transfer Protocol	km: Kilometer	NFPA: National Fire Protection Association
ga: Gauge	KTS: Key Telephone Service	NI: Network Interface
gHz: Gigahertz	kV: Kilovolt	NID: Network Interface Device
grd: Ground	kVA: Kilovolt Ampere	NIST: National Institute of Standards and Technology (formerly NBS)
GTO: Gas tube sign and oil-burner ignition cable. 5,000V-15,000V.	kW: Kilowatt	NIU: Network Interface Unit
H: Designation for intensity of magnetic energy	LAN: Local Area Network	nm: Nanometer
hc: Handset combination (single-line telephone)	LASER: Light Amplification by Stimulated Emission of Radiation	NM & NMC: Non Metallic Sheathed Cable, NEC Article 336 Cable Designation
HC: Horizontal cross-connect	LATA: Local Access Transport Area	NPLF: Non Power-Limited Fire Protective Signaling Circuit Cable, NEC Article 760 Cable Designation
hck: Handset combination; key (six-button telephone)	lbf: Pound force	NPLFP: Non Power-Limited Fire Protective Signaling Circuit Plenum Cable, NEC Article 760 Cable Designation
HDPE: High Density Polyethylene	LBO: Line Buildout	NPLFR: Non Power-Limited Fire Protective Signaling Circuit Plenum Cable, NEC Article 760 Cable Designation
HF: High Frequency	LDPE: Low Density Polyethylene	NRZ: Non Return to Zero
hh: Handhole	LEC: Local Exchange Carrier	NRZI: Non Return to Zero Inverted
Hi-Pot: A test designed to determine the highest voltage that can be applied to a conductor without breaking through the insulation.	LED: Light-Emitting Diode	OC: Optical Carrier
HPD: Rubber- and asbestos-insulated heater cord. No braid on individual conductors but with braid overall. Also made with neoprene insulation and no asbestos or PVC/NBC.	LLDPE: Linear Low Density Polyethylene	ODC: Ozone Depleting Chemical
HPN: Two-conductor, neoprene-insulated heater cord. Parallel construction. For use in damp locations.	LOCA: Loss of Coolant Accident	OP: Outside Plant
HSJ: Same as type HS but with #18, #16 and #14 conductors and differing thickness of jacket.	locap: Low-capacitance, low-loss paired cable	OPE: Outside Plant Engineer
HVAC: Heating, ventilation and air conditioning	MAC: Moves, Adds and Changes	OSHA: Occupational Safety and Health Administration
HZ: Hertz	MAP: Manufacturing Automation Protocol	OSI: Open Systems Interconnection
i: Symbol used to designate current	MATV: Master Antenna Television	OVE: Approval agency of West Germany; Oesterreichischer Verband fur Elektrotechnik
IC: Intermediate cross-connect	Mbps: Megabits per second	PABX: Private Automatic Branch Exchange
ICEA: Insulated Cable Engineers Association	MC: (1) main cross-connect (2) Metal Clad Cable, NEC Article 334 Cable Designation	PAM: Pulse Amplitude Modulation
IDC: Insulation Displacement Connector	MCM: One thousand circular mils	PAP: A commonly used term for air core (unfilled) direct burial telephone cable with a corrugated aluminum shield
IEC: International Electrotechnical Commission	MDF: Main Distribution Frame	PBX: Private Branch Exchange
IEEE: Institute of Electrical and Electronics Engineers	MDPE: Medium Density Polyethylene	PC: Personal Computer
IGS: Integrated Gas Spacer Cable, NEC Article 325 Cable Designation	Meg or Mega: A numerical prefix denoting 1,000,000 (10 ⁶)	PCB: Printed Circuit Board
IMSA: International Municipal Signal Association	M/G: Motor/Generator Set	P-FEP: Prysmian proprietary dielectric material used in junction with FEP.
in: Inch	MH: Manhole	PCM: Pulse Code Modulation
IRSC: Internet Research Steering Group	Mho: The unit of conductivity. The reciprocal of an ohm.	PCP: A commonly used term for air core (unfilled) direct burial cable with a corrugated copper shield
IRTF: Internet Research Task Force	MHz: Megahertz	PE: Polyethylene
IS: International Standard	Mi: Mineral Insulated Cable, NEC Article 330 Cable Designation	pf: Picofarad
ISA: Instrument Society of America	Micro: A numerical prefix denoting one-millionth (10 ⁶)	PFA: Polyfluoroalkoxy
ISDN: Integrated Services Digital Network	MIL STD: Military Standard	PIC: A general term for any type of plastic insulated telephone cable
ISO: International Organization for Standardization	MILNET: Military Network	Pico: A numerical prefix denoting one-millionth of one-millionth (10 ⁻¹²)
ISOC: Internet Society	MLT: Multi-Level Threshold	PL: Private Lines
ITCO: Independent Telephone Company	mm: Millimeter	PLSJ: All-rubber, parallel-jacketed, two-conductor, light-duty cord for pendant or portable use in damp locations. 300V.
ITU-T: International Telecommunications Union - Telecommunications Standardization Section	Modem: Modulator demodulator	PLT: (1) Plant (2) Same as PLSJ except thermo-plastic insulation
IW (C): Inside Wiring (cable)	MTT: Main Telephone Terminal	PLTC: Power Limited Tray Cable, NEC Article 725 Cable Designation
J: Joule	MTW: Machine Tool Wire	PM: Phase Modulation
kcmil: One thousand circular mils	MV: Medium Voltage Cable, NEC Article 326 Cable Designation	POI: Point Of Interface
KEMA KEUR: Approval agency of the Netherlands	MW: Radio hookup wire with polyvinyl insulation and plain or nylon jacket or braid, or shield, 1000V	POSJ: All-rubber, parallel, light duty rip-cord for use on lamps and small appliances, 300V, 60°C
kft: An abbreviation for 1000 ft.	N: Newton	
	NAIC: Network Applications and Information Center	
	NASA: National Aeronautics and Space Administration	
	NBR: Natural butadiene-acrylonitrile copolymer rubber	
	NBS: National Bureau of Standards (now NIST)	
	NEC: National Electrical Code	
	NEMA: National Electrical Manufacturers Association	
	NEMKO: Approval agency of Norway	
	NESC: National Electrical Safety Code	

Abbreviations & Acronyms

POT: Thermoplastic, parallel, light duty rip-cord. 300V, 60°C to 105°C.	SP-2: Same as SP-1, but heavier construction, with or without third conductor for grounding purposes. 300V.	TP-PMD: Twisted Pair-Physical Medium Dependent
POTS: Plain Old Telephone Service (colloquial)	SP-3: Same as SP-23, but heavier construction for refrigerators or room air conditioners. 300V.	TPDDI: Twisted Pair Distributed Data Interface
PP: Polypropylene	SPC: Stored Program Control	TSB: Telecommunications System Bulletin
PR: Pair	SPG: Single Point Ground	TT: Telephone Terminal
PTFE: Polytetrafluoroethylene	SPT-1: Same as SP-1, except all-thermoplastic. 300V. With or without third conductor for grounding.	TTB: Telephone Terminal Board
PTSS: Passive Transmission Sub-System	SPT-2: Same as SP-2, except all-thermoplastic. 300V. With or without third conductor for grounding.	TTY: Text Telephones
PVC: Polyvinyl Chloride	SPT-3: Same as SP-3, except all-thermoplastic. 300V. With or without third conductor for grounding.	TW: Thermoplastic vinyl-jacketed building wire, moisture-resistant. 60°C.
PVDF: Polyvinylidene Fluoride	SRD: Portable range or dryer cable. Three or four rubber-insulated conductors with rubber or neoprene jacket, flat or round construction. 300V, 60°C.	UCC: Uniform Code Council
R: Symbol for resistance	SRDT: Same as SRD, except all-thermoplastic with a maximum temperature of 90°C.	UF: Thermoplastic underground feeder and branch circuit cable
R-F: Radio-frequency	SRL: Structural return loss	UG: Underground
RCDD: Registered Communication Distribution Designer	ST: Hard-service cord, jacketed, same as type S except all-plastic construction, 600V, 60°C to 105°C.	UHF: Ultra High Frequency, 300 to 3,000 MHz
REA: Rural Electrification Administration	STA: Station	UL: Underwriter's Laboratories, Inc.
REP: Repair	STO: Same as ST but with oil-resistant thermo-plastic outer jacket. 600V, 60°C.	µm: Micron or micrometer
RFQ: Request for Quote	STP: Shielded twisted pair	UPC: Universal Packaging Code
RG/U: General utility grade military coaxial cable	SV: Vacuum cleaner cord, two or three-conductor, rubber-insulated. Overall rubber jacket. For light-duty in damp locations. 300V, 60°C.	UPS: Uninterruptible Power Supply
RH: Relative humidity	SVO: Same as SV except carolprene jacket, 300V, 60°C.	USE: Underground Service Entrance Cable, NEC Article 338 Cable Designation
RJ-45: A specific pin-point assignment for an eight position modular telecommunications connector.	SVT: Same as SV except all-plastic construction. With or without third conductor for grounding purposes only. 300V, 60°C to 90°C.	UTE: Approval agency for France; Union Technique de l'Electricite
RMS: (1) rack mount space (2) Root Mean Squares	SW: Station Wire	UTP: Unshielded twisted-pair
RoHS: Restriction on Hazardous Substances	SWB: Switchboard	V: Volt
S: Heavy-duty, rubber-insulated portable cord. Stranded copper conductors with separator and individual rubber insulation. Two or more color-coded conductors cabled with filler, wrapped with separator and rubber jacketed overall, 600 Volts.	SWR: Standing Wave Ratio	VDE: West Germany approval agency
SAE: Society of Automotive Engineers	SYS: System	VHF: Very High Frequency, 30 to 300 MHz
SANZ: Standards Association of New Zealand	TC: (1) Power and Control Tray Cable, NEC Article 340 Cable Designation (2) Telecommunications Closet	VP: Velocity of Propagation
SBR: Styrene Butadiene Rubber	TCP: Transmission Control Protocol	VSWR: Volume Standing Wave Ratio
ScTP: Screened Twisted Pair	TDM: Time-Division Multiplexing	VW-1: A flammability rating established by Underwriters Laboratories for wires and cables that pass a specially designed vertical flame test, (formerly designated FR-1)
SDN: Switched Digital Network	TEL: Telephone	W: Symbol for watt or wattage
SE: Service Entrance Cable, NEC Article 338 Cable Designation	TELCO: Telephone Company	WA: Work area
SEMKO: Approval agency for Sweden	TERM: Terminal or termination	WP: Waterproof Outlet
SFTP: Simple File Transfer Protocol	TEW: Canadian Standard Association type appliance wires. Solid or stranded single conductor, plastic-insulated, 600V, 105°C.	X: Cross-connect
SI: System Internationale	TF: Fixture wire, thermoplastic-covered solid or seven strands. 60°C.	XLPE: Crosslinked polyethylene
SJ: Junior hard-service, rubber-insulated pendant or portable cord. Same construction as type S, but 300V. Jacket thickness different.	TFE: Tetrafluoroethylene	Z: Symbol for impedance
SJO: Same as SJ, but carolprene, oil-resistant compound outer jacket. Can also be made "water-resistant." 300V, 60°C.	TFF: Same as TF but flexible stranding. 60°C.	
SJT: Junior hard service thermoplastic or rubber-insulated conductors with overall thermoplastic jacket, 300V, 60°C to 105°C.	THHN: 90°C, 600V nylon jacketed building wire	
SJTO: Same as SJT but oil-resistant thermoplastic outer jacket. 60°C.	THW: Thermoplastic vinyl-insulated building wire. Flame-retardant, moisture- and heat-resistant. 75°C. Dry and wet locations.	
SMTP: Simple Mail Transfer Protocol	THWN: Same as THW but with nylon jacket overall. 75°C.	
SNA: Systems Network Architecture	TIA: Telecommunications Industry Association	
SNM: Shielded Non Metallic Sheathed Cable, NEC Article 337 Cable Designation	TOC: Tin Overcoat	
SNMP: Simple Network Management Protocol	TP: Transport Protocol	
SNR: Signal to Noise Ratio		
SO: Hard-service cord, same construction as type S except oil-resistant carolprene jacket, 600V, 60° to 90°C.		
SONET: Synchronous Optical Network		
SP-1: All rubber, parallel-jacketed, two-conductor light-duty cord for pendant or portable use in damp locations. 300V.		

Hook-Up Wire Product Finder

TEMP. °C	VOLTAGE	UL	UL	CSA	MIL	AWG	P/N	STRAND TYPE	PAGE
60	1500*	—	—	—	—	20	C1326	STRANDED	147
60	3000*	—	—	—	—	20	C1319	STRANDED	147
60	5000*	—	—	—	—	18	C1320A	STRANDED	147
60	5000*	—	—	—	—	18	C1321	STRANDED	147
60	10000*	—	—	—	—	18	C1318	STRANDED	147
80/105	300	1007	1569	TR-64	—	24	C2003A	SOLID	143
80/105	300	1007	1569	TR-64	—	24	C2015A	STRANDED	143
80/105	300	1007	1569	TR-64	—	22	C2004A	SOLID	143
80/105	300	1007	1569	TR-64	—	22	C2016A	STRANDED	143
80/105	300	1007	1569	TR-64	—	20	C2028A	SOLID	143
80/105	300	1007	1569	TR-64	—	20	C2040A	STRANDED	143
80/105	300	1007	1569	TR-64	—	18	C2052A	SOLID	143
80/105	300	1007	1569	TR-64	—	18	C2064A	STRANDED	143
80/105	300	1007	1569	TR-64	—	16	C2053A	SOLID	143
80/105	300	1007	1569	TR-64	—	16	C2065A	STRANDED	143
105	600	1015	—	TEW	—	24	C2100A	STRANDED	144
105	600	1015	—	TEW	—	22	C2101A	STRANDED	144
105	600	1015	—	TEW	—	22	C2117A	SOLID	144
105	600	1015	—	TEW	—	20	C2102A	STRANDED	144
105	600	1015	—	TEW	—	20	C2118A	SOLID	144
105	600	1015	—	TEW	—	18	C2103A	STRANDED	144
105	600	1015	—	TEW	—	18	C2119A	SOLID	144
105	600	1015	—	TEW	—	16	C2104A	STRANDED	144
105	600	1015	—	TEW	—	14	C2105A	STRANDED	144
105	600	1015	—	TEW	—	12	C2106A	STRANDED	144
105	600	1015	—	TEW	—	10	C2107A	STRANDED	144

* For intermittent duty only

Multi-Conductor Cable Product Finder

NO. COND.	STRAND TYPE	AWG 24		AWG 22		AWG 20		AWG 18		AWG 16		AWG 14		AWG 12		
		P/N	SHIELD PAGE	P/N	SHIELD PAGE	P/N	SHIELD PAGE	P/N	SHIELD PAGE	P/N	SHIELD PAGE	P/N	SHIELD PAGE	P/N	SHIELD PAGE	
2	Solid			C2515A F.....15 C4167A F.....19 C2676A B.....25 E1482S U.....81 E2482S F.....83 E3482S U-P.....85 E3542S F-P.....88 E1000S U.....89, 98 E2000S F.....90, 99 E3000S U-P 86, 100 E2100S F-P . 87, 101		C4311A U.....2		C3110 U-P.....9 C3060 F-P.....18 E2402S U.....81 E1502S U.....81 C4304A U.....82 E2502S F.....83 C4334A F.....84 E3502S U-P.....85		E2404S U.....81 E1512S U.....81 C4321A U.....82 E2522S F.....83 C4344A F.....84 E3512S U-P.....85		E2406S U.....81 E1522S U.....81 C4324A U.....82 E2532S F.....83 C4347A F.....84 E3522S U-P.....85		E1532S U.....81 C4327A U.....82 E2542S F.....83 C4348A F.....84 E3532S U-P.....85		E3632S F-P.....88 C0492 U.....91 C0476 F.....92 C3246 U-P.....93 C3174 F-P.....94
	Stranded	C2461A U.....4 C2513A F.....15 C4152A F.....19 C4216A F.....21 C0740A F.....45	C6348A U.....5 C3105 U-P.....8 C3115 U-P.....9 C4100A U.....12 C0431A U.....14 C2514A F.....15 C2516A F.....15 C2518A F.....16 C2520A F.....16 C3158 F-P.....18 C4153A F.....19 C3115 U-P.....9 C4168A F.....19 C4192A F.....20 C4210A F.....20 C0450A F.....23 C2882A S.....24 C2677A B.....25 C2679A B.....27 C6700A U.....13 C0760A F.....46 E1002S U.....89, 98 E2002S F.....89, 99 E3002S U-P 86, 100 E2102S F-P . 87, 101 C6892A F.....22 C6810A F.....22	C6351A U.....6 C4117A U.....10 C0433A U.....14 C2524A F.....15 C2540A F.....15 C2519A F.....16 C4154A F.....19 C4166A F.....20 C4211A F.....20 C0452A F.....23 C2888A S.....24 C1642A B.....26 C2681A B.....27 C3602 U-R.....29 C1302 B-R.....30 C6717A U.....13 C0780A F.....46 E1022S U.....89, 98 E2022S F.....90, 99 E3022S U-P 86, 100 E2122S F-P . 87, 101 C6866A F.....22 C6811A F.....22	C2830A U.....6 C3102 U-P.....8 C3112 U-P.....9 C4125A U.....10 C4214A U.....10 C0435A U.....14 C2534A F.....15 C2521A F.....16 C3062 F-P.....18 C4155A F.....19 C4197A F.....20 C4212A F.....20 C0454A F.....23 C2892A S.....24 C2686A B.....27 C1202 B-C.....31, 138 C6725A U.....13 C6714A U.....13 E1032S U.....89, 98 E2032S F.....90, 99 E3032S U-P 86, 100 E2202S F-P . 87, 101 C6897A F.....22 C6812A F.....22	C2405A U.....7 C3193 U-P.....8 C3127 U-P.....9 C4135A U.....11 C0437A U.....14 C2536A F.....15 C3169 F-P.....94 C3068 F-P.....18 C4162A F.....19 C4199A F.....20 C4213A F.....20 C0456A F.....23 C2895A S.....24 C2689A B.....27 C1602 B-C.....31, 138 C6735A U.....13 E1042S U.....89, 98 E2042S F.....90, 99 E3042S U-P 86, 100 E2242S F-P . 87, 101 C6899A F.....22 C6813A F.....22	C2409A U.....7 C3126 U-P.....8 C3128 U-P.....9 C4146A U.....11 C0439A U.....14 C2538A F.....15 C4163A F.....19 C4201A F.....20 C4215A F.....20 C0458A F.....20 C6746A U.....13 E1052S U.....89, 98 E2052S F.....90, 99 E3052S U-P 86, 100 E2252S F-P . 87, 101 C6801A F.....22 C6815A F.....22	C2410A U.....7 C3135 U-P.....8 C3129 U-P.....9 C4150A U.....11 C0441A U.....14 C2539A F.....15 C4164A F.....19 C4202A F.....20 C0460A F.....23 E1062S U.....89, 98 E2062S F.....90, 99 E3062S U-P 86, 100 E2262S F-P . 87, 101								
3	Solid							C3114 U-P.....9 E1503S U.....81 C4305A U.....82 E2503S F.....83 C4335A F.....84 E3503S U-P.....85 E3603S F-P.....88		C4322A U.....82 C4345A F.....84		C4325A U.....82				
	Stranded	C2462A U.....4 C4217A F.....21 C0741A F.....45 C0951A FB.....47 C0680A FB.....49	C4062A U.....5 C4101A U.....12 C0432A U.....14 C2526A F.....15 C2517A F.....15 C4156A F.....19 C4169A F.....19 C4193A F.....20 C0451A F.....23 C1335A S.....24 C2678A B.....27 C6701A U.....13 C0761A F.....46 C0971A FB.....48 E1003S U.....89, 98 E2003S F.....90, 99 E3003S U-P 86, 100 E2103S F-P . 87, 101 C6893A F.....22	C6352A U.....6 C4118A U.....10 C0434A U.....14 C2528A F.....15 C2525A F.....15 C4157A F.....19 C4158A F.....19 C4195A F.....20 C0453A F.....23 C1643A B.....26 C1332A B.....27 C3603 U-R.....29 C1304 B-R.....30 C0781A F.....46 E1023S U.....89, 98 E2023S F.....90, 99 E3023S U-P 86, 100 E2123S F-P . 87, 101	C2831A U.....6 C3190 U-P.....8 C3120 U-P.....9 C4126A U.....10 C0436A U.....14 C2535A F.....15 C3064 F-P.....18 C4159A F.....19 C4198A F.....20 C0455A F.....23 C2768A S.....24 C2687A B.....27 C1203 B-C.....31 C6726A U.....13 E1033S U.....89, 98 E2033S F.....90, 99 E3033S U-P 86, 100 E2203S F-P . 87, 101 C6898A F.....22	C2406A U.....7 C3194 U-P.....8 C4136A U.....11 C0438A U.....14 C4200A F.....20 C0457A F.....23 C1603 B-C.....31 C6736A U.....13 E1043S U.....89, 98 E2043S F.....90, 99 E3043S U-P 86, 100 E2243S F-P . 87, 101 C6800A F.....22	C0440A U.....14 C0459A F.....23									

B - Braid Shield
 C - Carolprene®
 F - Foil Shield
 FB - Foil + Braid Shield
 I - Individual Foil Shield
 IFB - Individual Foil + Braid Shield
 P - Plenum
 R - Rubber
 S - Spiral Shield
 U - Unshielded



Multi-Conductor Cable Product Finder

NO. COND.	STRAND TYPE	AWG 24		AWG 22		AWG 20		AWG 18		AWG 16		AWG 14		AWG 12	
		P/N	SHIELD PAGE	P/N	SHIELD PAGE	P/N	SHIELD PAGE	P/N	SHIELD PAGE	P/N	SHIELD PAGE	P/N	SHIELD PAGE	P/N	SHIELD PAGE
4	Solid			E1484S U81 E2484S F 83 E3484S U-P 85 E1001S U89, 98 E3001S U-P 86, 100				C3111 U-P9 C3061 F-P18 E1504S U81 C4306A U 82 E2504S F 83 C4336A F 84 E3504S U-P 85 E3604S F-P 88 C0485 U91 C0494 F 92 C3242 U-P 93 C3170 F-P 94	E1514S U81 C4323A U 82 E2524S F 83 C4346A F 84 E3514S U-P 85 E3614S F-P 88 C0486 U91 C0495 F 92 C3243 U-P 93 C3171 F-P 94	E1524S U81 C4326A U 82 E2534S F 83 E3524S U-P 85 E3624S F-P 88 C0496 F 92 C3245 U-P 93 C3173 F-P 94	E1534S U81 E2544S F 83 E3534S U-P 85 E3634S F-P 88 C0497 F 92 C3247 U-P 93 C3175 F-P 94				
	Stranded	C2463A U 4 C4218A F 21 C0742A F 45 C0952A FB 47 C0681A FB 49	C3159 F-P18 C4160A F19 C4194A F 20 C1337A S 24 C2680A B 27 C6702A U13 C0762A F 46 C0972A FB 48 E1004S U89, 98 E2004S F90, 99 E3004S U-P 86, 100 E2104S F-P . 87, 101 C4063A U5 C3106 U-P8 C3116 U-P9 C4102A U12 C2523A F15 C6894A F 22	C6353A U6 C4119A U10 C2555A F15 C4161A F19 C4196A F20 C1644A B 26 C2683A B 27 C3604 U-R 29 C1305 B-R 30 C6718A U13 C0782A F 46 E1024S U89, 98 E2024S F90, 99 E3024S U-P 86, 100 E2124S F-P . 87, 101 C6896A F 22	C2404A U6 C3103 U-P9 C3113 U-P10 C4127A U11 C0444A U15 C2543A F18 C8114 F-P19 C3063 F-P 20 C4204A F 22 C2688A B 29 C8110 FB-P32 C6727A U14 E1034S U ... 91, 100 E2034S F 92, 101 E3034S U-P 88, 102 E2204S F-P 89, 103 C6804A F 24	C2425A U7 C3195 U-P8 C4137A U 11 C1604 B-C 31 C6737A U13 E1044S U89, 98 E2044S F90, 99 E3044S U-P 86, 100 E2244S F-P. 87, 101 C6837A F 22	C2430A U7 C4147A U 11 C6747A U13 E1054S U89, 98 E2054S F90, 99 E3054S U-P 86, 100 E2254S F-P. 87, 101	C2440A U7 C4151A U 11 E1064S U89, 98 E2064S F90, 99 E3064S U-P 86, 100 E2264S F-P. 87, 101							
5	Solid						C3117 U-P9 E1505S U81 C4307A U 82 C4337A F 84	C4349A U 82 C4350A F 84							
	Stranded	C2464A U 4 C4219A F 21 C0753A F 45 C0953A FB 47 C0682A FB 49	C4064A U5 C4103A U12 C0973A FB 48 C4207A F 20 C1341A S 24 C6704A U13 C0763A F 46 C0974A FB 48 E1006S U89, 98 E2006S F90, 99 E3006S U-P 86, 100 E2106S F-P . 87, 101 C6807A F 22	C6355A U6 C4120A U10 C1645A B 26 C1646A B 26 C3606 U-R 29 C1310 B-R 30 C0783A F 46	C2420A U6 C3134 U-P8 C3125 U-P9 C4128A U10 C3065 F-P18 C4205A F 20 C1206 B-C 31 C6706A U13 E1036S U89, 98 E2036S F90, 99 E3036S U-P 86, 100 E2206S F-P. 87, 101 C6805A F 22	C2434A U7 C4138A U 11	C2437A U7 C4148A U 11								
6	Solid		E1486S U81 C4300A U 82				C3118 U-P9 E1506S U81 C4308A U 82 E2506S F 83 C4338A F 84 E3506S U-P 85 E3606S F-P 88								
	Stranded	C2466A U 4 C4220A F 21 C0743A F 46 C0954A FB 47 C0683A FB 49	C4066A U5 C4104A U12 C4207A F 20 C1341A S 24 C6704A U13 C0763A F 46 C0974A FB 48 E1006S U89, 98 E2006S F90, 99 E3006S U-P 86, 100 E2106S F-P . 87, 101 C6807A F 22	C1646A B 26 C3606 U-R 29 C1310 B-R 30 C0783A F 46	C3192 U-P8 C3121 U-P9 C4206A U10 C3065 F-P18 C4205A F 20 C1206 B-C 31 C6706A U13 E1036S U89, 98 E2036S F90, 99 E3036S U-P 86, 100 E2206S F-P. 87, 101 C6805A F 22										
7	Solid						C4309A U 82 C4339A F 84								
	Stranded	C2488A U 4 C4221A F 21 C0754A F 45 C0955A FB 47 C0684A FB 49	C4088A U5 C4105A U12 C0975A FB 48	C6356A U6 C4121A U10 C3607 U-R 29 C1312 B-R 30	C2421A U6 C4129A U10 C2426A U7 C4139A U 11	C2431A U7 C4149A U 11									

B - Braid Shield
C - Carolprene®
F - Foil Shield
FB - Foil + Braid Shield
I - Individual Foil Shield
IFB - Individual Foil + Braid Shield
P - Plenum
R - Rubber
S - Spiral Shield
U - Unshielded



Multi-Conductor Cable Product Finder

NO. COND.	STRAND TYPE	AWG 24		AWG 22		AWG 20		AWG 18		AWG 16		AWG 14		AWG 12	
		P/N	SHIELD PAGE	P/N	SHIELD PAGE	P/N	SHIELD PAGE	P/N	SHIELD PAGE	P/N	SHIELD PAGE	P/N	SHIELD PAGE	P/N	SHIELD PAGE
8	Solid							C3119 U-P.....9 E1508S U.....81 C4310A U.....82 E2508S F.....83 C4340A F.....84							
	Stranded	C2465A U.....4 C4222A F.....21 C0744A F.....45 C0956A FB.....47 C0685A FB.....49		C4065A U.....5 C4106A U.....12 C4208A F.....20 C0764A F.....46 C0976A FB.....48 E1008S U.....89,98 E2008S F.....90,99 E3008S U-P 86,100 E2108S F-P.. 87,101		C1648A FB.....28 C3608 U-R.....29 C1313 B-R.....30 C0784A F.....46		C3191 U-P.....8 C3122 U-P.....9 E1038S U.....89,98 E2038S F.....90,99 E3038S U-P 86,100 E2208S F-P.. 87,101		C2443A U.....7 C4140A U.....11					
9	Solid							C4312A U.....82 C4341A F.....84							
	Stranded	C2470A U.....4 C4223A F.....21 C0755A F.....45 C0957A FB.....47 C0686A FB.....49		C4070A U.....5 C4107A U.....12 C0977A FB.....48		C6357A U.....6 C4122A U.....10		C2422A U.....6 C4130A U.....10		C2435A U.....7 C4141A U.....11					
10	Solid							C4313A U.....82 C4342A F.....84							
	Stranded	C2471A U.....4 C4224A F.....21 C0745A F.....45 C0958A FB.....47 C0687A FB.....49		C4071A U.....5 C4108A U.....12 C0765A F.....46 C0978A FB.....48 E1010S U.....89,98 E2010S F.....90,99 E3010S U-P 86,100 E2110S F-P.. 87,101		C3610 U-R.....29 C0785A F.....46		C3178 U-P.....8 C3123 U-P.....9 C3183 F-P.....18 E1040S U.....89,98 E2040S F.....90,99							
11	Solid							C4314A U.....82							
12	Stranded	C2467A U.....4		C4067A U.....5 C4109A U.....12 E1012S U.....89,98 E2012S F.....90,99 E3012S U-P 86,100 E2112S F-P.. 87,101		C6360A U.....6 C4123A U.....10		C2412A U.....6 C3179 U-P.....8 C3124 U-P.....9 C4131A U.....10 C3184 F-P.....18 E1041S U.....89,98 E2041S F.....90,99		C2427A U.....7 C4142A U.....11					
15	Solid			C4301A U.....82											
	Stranded	C2473A U.....4 C4225A F.....21 C0746A F.....45 C0959A FB.....47 C0688A FB.....49		C4073A U.....5 C4110A U.....12 C0766A F.....46 C0979A FB.....48 C4111A U.....12		C6358A U.....6 C4124A U.....10 C0786A F.....46		C2423A U.....6 C4132A U.....10		C2428A U.....7 C4143A U.....11					
19	Solid							C2424A U.....6							
	Stranded							C4133A U.....10		C2429A U.....7 C4144A U.....11					
20	Solid			C4302A U.....82				C4316A U.....82							
	Stranded	C4226A F.....21 C0747A F.....45 C0960A FB.....47		C4075A U.....5 C4112A U.....12 C0767A F.....46 C0980A FB.....48											
21	Solid							C4317A U.....82							
	Stranded														
25	Solid														
	Stranded	C4227A F.....21 C0748A F.....45 C0961A FB.....47		C4076A U.....5 C4113A U.....12 C0768A F.....46 C0981A FB.....48		C0787A F.....46 C0788A F.....46		C2433A U.....6 C4134A U.....10		C2436A U.....7 C4145A U.....11					
27	Solid														
	Stranded														
30	Solid							C4318A U.....82 C4343A F.....84							
	Stranded	C4228A F.....21 C0749A F.....45		C4077A U.....5 C4114A U.....12											
40	Solid														
	Stranded	C4229A F.....21 C0750A F.....45		C4078A U.....5 C4115A U.....12											
50	Solid														
	Stranded	C4230A F.....21 C0751A F.....45		C4079A U.....5 C4116A U.....12											



B - Braid Shield
 C - Carolprene®
 F - Foil Shield
 FB - Foil + Braid Shield
 I - Individual Foil Shield

IFB - Individual Foil + Braid Shield
 P - Plenum
 R - Rubber
 S - Spiral Shield
 U - Unshielded



Multi-Conductor Cable Product Finder

NO. PAIR	STRAND TYPE	AWG 28		AWG 24		AWG 22		AWG 20		AWG 18	
		P/N SHIELD	PAGE	P/N SHIELD	PAGE	P/N SHIELD	PAGE	P/N SHIELD	PAGE	P/N SHIELD	PAGE
1	SOLID					C4008A U.....	34				
	STRANDED			C4170A F..... C4209A F..... C4191A F..... C0600A F..... C0841A FB.....	38 38 38 50 53	C7104A F..... C3204 F-P..... C4183A F..... C7112A F..... C0720A F.....	36 37 39 43 50			C6101A U.....	35
2	SOLID					C4010A U..... C1670A F.....	34 36				
	STRANDED			C3150 F-P..... C4171A F..... C0601A F..... C0890A F..... C0620A FB..... C0842A FB..... C0829A FB..... C0515A FB..... C0910A I..... C0924A IFB.....	37 38 50 51 52 53 54 55 57 58	C6010A U..... C3205 F-P..... C4184A F..... C1352A I..... C1353A I..... C4203A I..... C0570A I..... C0550A F..... C7114A F..... C0721A F..... C0650A FB.....	34 37 39 40 40 41 42 43 43 50 52	C7106A I.....	40	C6118A U..... C0584A I..... C0560A F.....	35 42 43
3	SOLID					C4014A U.....	34				
	STRANDED			C3153 F-P..... C4172A F..... C0602A F..... C0901A F..... C0621A FB..... C0843A FB..... C0830A FB..... C0516A FB..... C6065A I..... C0911A I..... C0925A IFB.....	37 38 50 51 52 53 54 55 56 57 58	C6014A U..... C3206 F-P..... C4185A F..... C0571A I..... C0551A F..... C7116A F..... C0722A F..... C0651A FB..... C6040A I.....	34 37 39 42 43 43 50 52 56	C6052A I.....	56	C6103A U..... C0585A I..... C0561A F..... C6047A I.....	35 42 43 56
4	SOLID					C4015A U..... C1676A F.....	34 36				
	STRANDED			C3151 F-P..... C4173A F..... C0603A F..... C0893A F..... C0622A FB..... C0844A FB..... C0831A FB..... C0517A FB..... C0912A I.....	37 38 50 51 52 53 54 55 57	C6015A U..... C3207 F-P..... C4186A F..... C0572A I..... C0552A F..... C0723A F..... C0652A FB.....	34 37 39 42 43 50 52			C6119A U..... C0586A I..... C0562A F.....	35 42 43
4.5	Solid										
	Stranded										
5	Solid									C3120 U.....	9
	Stranded			C4174A F..... C0604A F..... C0894A F..... C0623A FB..... C0832A FB..... C0518A FB.....	38 50 51 52 54 55	C4187A F..... C0724A F..... C0653A FB.....	39 50 52				

B - Braid Shield
 C - Carolprene®
 F - Foil Shield
 FB - Foil + Braid Shield
 I - Individual Foil Shield
 IFB - Individual Foil + Braid Shield
 P - Plenum
 R - Rubber
 S - Spiral Shield
 U - Unshielded



Multi-Conductor Cable Product Finder

NO. PAIR	STRAND TYPE	AWG 28		AWG 24		AWG 22		AWG 20		AWG 18	
		P/N SHIELD	PAGE	P/N SHIELD	PAGE	P/N SHIELD	PAGE	P/N SHIELD	PAGE	P/N SHIELD	PAGE
6	Solid					C4017A U 34 C1671A F 36					
	Stranded			C3165 F-P 37 C4175A F 38 C0605A F 50 C0899A F 51 C0624A FB 52 C0839A FB 54 C0519A FB 55 C6066A I 56 C0913A I 57		C6017A U 34 C3208 F-P 37 C4188A F 39 C0573A I 42 C0553A F 43 C0725A F 50 C0654A FB 52 C6041A I 56		C6053A I 56		C6106A U 35 C0587A I 42 C0563A F 43 C6048A I 56	
7	Solid										
	Stranded			C4176A F 38 C0606A F 50 C0625A FB 52 C0833A FB 54 C0520A FB 55		C0655A FB 52					
8	Solid										
	Stranded			C4177A F 38 C0607A F 50 C0626A FB 52 C0521A FB 55		C0656A FB 52				C6121A U 35	
9	Solid					C1672A F 36					
	Stranded			C4178A F 38 C0608A F 50 C0896A F 51 C6067A I 56 C0914A I 57		C6019A U 34 C4189A F 39 C0574A I 42 C0554A F 43 C0726A F 50 C6042A I 56		C6054A I 56		C6109A U 35 C0588A I 42 C0564A F 43 C6049A I 56	
10	Solid										
	Stranded			C4179A F 38 C0609A F 50 C0628A FB 52 C0835A FB 54 C0522A FB 55		C0658A FB 52					
11	Solid										
	Stranded			C0915A I 57		C0575A I 42 C0555A F 43 C6043A I 56				C0589A I 42	
12	Solid										
	Stranded			C0836A FB 54 C0916A I 57		C6023A U 34 C6059A I 56		C6056A I 56		C6050A I 56	
12.5	Solid										
	Stranded			C3152 F-P 37 C0897A F 51 C0630A FB 52 C0523A FB 55		C0660A FB 52					
15	Solid					C1673A F 36					
	Stranded			C4180A F 38 C0610A F 50 C0524A FB 55 C0917A I 57		C6026A U 34 C4190A F 39 C0556A F 43 C0728A F 50 C6044A I 56		C6058A I 56		C6111A U 35 C0590A I 42 C0566A F 43 C6051A I 56	

B - Braid Shield
 C - Carolprene®
 F - Foil Shield
 FB - Foil + Braid Shield
 I - Individual Foil Shield
 IFB - Individual Foil + Braid Shield
 P - Plenum
 R - Rubber
 S - Spiral Shield
 U - Unshielded



Multi-Conductor Cable Product Finder

NO. PAIR	STRAND TYPE	AWG 28		AWG 24		AWG 22		AWG 20		AWG 18	
		P/N SHIELD	PAGE	P/N SHIELD	PAGE	P/N SHIELD	PAGE	P/N SHIELD	PAGE	P/N SHIELD	PAGE
17	Solid										
	Stranded					C6060A I.....	.56				
18	Solid										
	Stranded			C0525A FB.....	.55						
19	Solid										
	Stranded			C4181A F.....	.38	C0729A F.....	.50				
				C0611A F.....	.50	C6045A I.....	.56				
25	Solid										
	Stranded			C4182A F.....	.38	C0663A FB.....	.52				
				C0612A F.....	.50						
				C0526A FB.....	.55						
27	Solid										
	Stranded					C0730A F.....	.50				
						C6046A I.....	.56				
51	Solid										
	Stranded										

B - Braid Shield
 C - Carolprene®
 F - Foil Shield
 FB - Foil + Braid Shield
 I - Individual Foil Shield
 IFB - Individual Foil + Braid Shield
 P - Plenum
 R - Rubber
 S - Spiral Shield
 U - Unshielded

CAROL® Electronics Cable

CAROL to Belden Cross-Reference Guide



Communication and Control Cable – New 105°C Rating

Belden	CAROL	Belden	CAROL	Belden	CAROL	Belden	CAROL	Belden	CAROL	Belden	CAROL
1883A	C0600A	8444	C4063A	8477	C2410A	9302	C1670A	9502	C0601A	9540	C0745A
5541FE	C0721A	8445	C4064A	8489	C2404A	9406	C1350A	9503	C0602A	9541	C0746A
8205	C6351	8456	C4071A	8619	C2424A	9418	C2543A	9504	C0603A	9542	C0747A
8302	C0650A	8458	C4073A	8620	C2425A	9423	C4070A	9505	C0604A	9543	C0748A
8303	C0651A	8459	C4076A	8621	C2426A	9430	C4088A	9506	C0605A	9626	C2433A
8304	C0652A	8465	C2420A	8622	C2427A	9431	C4075A	9533	C0741A	9740	C6101A
8306	C0654A	8466	C2412A	8627	C2430A	9432	C4077A	9534	C0742A	9744	C6102A
8332	C0620A	8467	C2421A	8690	C6103A	9444	C6353A	9535	C0753A	9939	C0971A
8335	C0623A	8468	C2423A	8691	C6106A	9445	C6355A	9536	C0743A	9940	C0972A
8441	C2677A	8469	C2422A	8740	C4008A	9455	C6357A	9537	C0754A		
8442	C6348A	8471	C2405A	8780	C2895A	9457	C6360A	9538	C0744A		
8443	C4062A	8473	C2409A	9156	C6118	9458	C6358A	9539	C0755A		

Communication and Control Cable

Belden	CAROL	Belden	CAROL	Belden	CAROL	Belden	CAROL	Belden	CAROL	Belden	CAROL
1266A	C2516A	8405	C1645A	8772	C2528A	9369	C0585A	9544	C0749A	9829	C0829A
3107A	C7114A	8446	C4081	8773	C6046A	9388	C0586A	9545	C0750A	9841	C4841A
3108A	C7116A	8447	C4082A	8774	C6042A	9389	C0587A	9546	C0751A	9842	C4842A
5120FJ	C0475	8448	C4083A	8775	C6043A	9390	C0588A	9608	C0951A	9843	C4843A
5220FJ	C0474	8449	C4084A	8776	C6044A	9407	C0431A	9609	C0952A	9844	C4844A
5545FE	C0725A	8450	C2515A	87760	C8104	9408	C0433A	9610	C0953A	9855	C8004
6000UC	C3129	8451	C2516A	87761	C8103	9409	C0435A	9611	C0954A	9873	C6052A
6100UF	C3128	8457	C4067A	8777	C6040A	9410	C0437A	9621	C2435A	9874	C6053A
6220FK	C3168	8486	C2754A	8778	C6041A	9411	C0439A	9622	C2436A	9875	C6054A
8162	C0924A	8487	C2755A	8790	C2892A	9412	C0441A	9681	C0616A	9877	C6056A
8163	C0925A	8623	C2428A	8791	C2768A	9421	C4065A	9682	C0617A	9879	C6058A
8164	C0926A	8624	C2429A	88102	C8118	9433	C4078A	9683	C0618A	9925	C0680A
82503	C8113	8628	C2431A	88723	C8112	9434	C4079A	9684	C0619A	9927	C0681A
82641	C8127	8641	C2513A	88760	C8101	9451	C2520A	9696	C8006	9929	C0682A
82723	C8105	8692	C6109A	88761	C8109	9451P	C8124	9721	C2443A	9931	C0683A
82729	C8134	8718	C2539A	88778	C8132	9460	C2521A	9728	C0912A	9932	C0684A
82740	C8122	8719	C2536A	89418	C8114	9461	C2518A	9729	C0910A	9933	C0685A
82760	C8123	8720	C2538A	89729	C8128	9462	C7104A	9730	C0911A	9934	C0686A
82761	C8126	8723	C1352A	89740	C8116	9464	C2519A	9731	C0913A	9935	C0687A
82777	C8131	8725	C1368A	89841	C8117	9491	C0432A	9732	C0914A	9936	C0688A
82778	C8133	8728	C1353A	9157	C6119	9492	C0432A	9733	C0915A	9947	C0979A
8305	C0653A	8729	C7110A	9159	C6120	9493	C0436A	9735	C0917A	9990	C6065A
8307	C0655A	8735	C2678A	9161	C6121	9494	C0438A	9745	C6014A	9991	C6066A
8308	C0566A	8737	C2882A	9305	C1676A	9495	C0440A	9746	C6015A	9992	C6067A
8310	C0658	8741	C4010A	9306	C1671A	9501	C0600A	9768	C6059A		
8312	C0660A	8742	C4014A	9309	C1672A	9507	C0606A	9773	C6047A		
8307	C0655A	8747	C6017A	9315	C1673A	9508	C0607A	9774	C6048A		
8308	C0566A	8751	C6451A	9328	C0570A	9509	C0608A	9775	C6049A		
8310	C0658	8757	C4015A	9329	C0571A	9510	C0609A	9776	C6050A		
8312	C0660A	8760	C2534A	9330	C0572A	9512	C0550A	9777	C6051A		
8333	C0621A	8761	C2514A	9331	C0573A	9513	C0551A	9791	C0533A		
8334	C0622A	8762	C2524A	9363	C0451A	9514	C0552A	9804	C0804A		
8336	C0624A	8767	C6035A	9364	C0453A	9515	C0610A	9805	C0805A		
8337	C0625A	8768	C6036A	9365	C0455A	9516	C0553A	9806	C0806A		
8340	C0628A	8769	C6045A	9366	C0457A	9519	C0611A	9807	C0807A		
8342	C0630A	8770	C2535A	9367	C0459A	9520	C0554A	9808	C0808A		
83654	C8110	8771	C2526A	9368	C0584A	9525	C0612A	9812	C0812A		



Prysmian North America
 4 Tessenner Drive, Highland Heights, KY 41076
 +1-859-572-8000 /na.prysmian.com

CAROL® Electronics Cable

CAROL to Belden Cross-Reference Guide



Alarm and Security, Fire Alarm and Coaxial Cable – New 105°C Rating

Belden	CAROL	Belden	CAROL	Belden	CAROL	Belden	CAROL	Belden	CAROL	Belden	CAROL
5000FE	E2062S	5122UL	E1524S	5222UL	E1514S	5322FL	E2504S	5501FE	E2003S	5509FE	E2012S
5020FL	E2542S	5200FE	E2042S	5300FE	E2032S	5322UL	E1504S	5501UE	E1003S	5509UE	E1012S
5020UL	E1532S	5200UE	E1042S	5300UE	E1032S	5400FE	E2022S	5502FE	E2004S	5520UE	E1000S
5100FE	E2052S	5201FE	E2043S	5301FE	E2033S	5401FE	E2023S	5502UE	E1004S	5522UE	E1001S
5100UE	E1052S	5202FE	E2044S	5302FE	E2034S	5402FE	E2024S	5504FE	E2006S		
5102A	E1054S	5202UL	E1044S	5302UE	E1034S	5402UE	E1024S	5504UE	E1006S		
5120FL	E2532S	5220FL	E2522S	5304UE	E1036S	5400UE	E1022S	5506FE	E2008S		
5120UL	E1522S	5220UL	E1512S	5320FL	E2502S	5500FE	E2002S	5506UE	E1008S		
5122FL	E2534S	5222FL	E2524S	5320UL	E1502S	5500UE	E1002S	5508FE	E2010S		

Alarm and Security, Fire Alarm and Coaxial Cable

Belden	CAROL	Belden	CAROL	Belden	CAROL	Belden	CAROL	Belden	CAROL	Belden	CAROL
1186A	C5784	513945	395058	6102UE	E3054S	6400FE	E2122S	8213	C5025	9116	C5775
1189A	C5785	5201UE	E1043S	6120FL	E3622S	6400UE	E3022S	8214	C1198	9117	C5802
1190A	C5804	5202UE	E1044S	6120UL	E3522S	6401FE	E2123S	8215	C5810	9141	C5838
1223A	C5812	5220LL	E2404S	6122UL	E3524S	6401UE	E3023S	8216	C1156	9182	C8014
1242A	E1001S	5301UE	E1033S	6220FL	E3612S	6402FE	E2124S	8218	C1158	9201	C1117
1266A	E2022S	5308UE	E1040S	6220UL	E3512S	6402UE	E3024S	8219	C1188	9243	C5782
1322R	C5889	5320FE	E2030S	6222FL	E3614S	6500FE	E2102S	8221	C1135	9244	C5836
1426A	C1142	5320LL	E2402S	6222UL	E3514S	6500UE	E3002S	82262	C3520	9259	C1103
1513A	C5776	5320UE	E1030S	6300FE	E2202S	6501FE	E2103S	8228	C5760	9265	C8025
1523A	C5039	5321FL	E2503S	6300UE	E3032S	6501UE	E3003S	8233	C5027	9269	C1164
1524A	C5041	5321UL	E1503S	6301FE	E2203S	6502FE	E2104S	8237	C1154	9271	C8012
1530A	C5776	5324UL	E1506S	6302FE	E2204S	6502UE	E3004S	82442	E3002S	9275	C5780
1613A	C5812	5339Q5	395014	6304FE	E2206S	6504FE	E2106S	8259	C1178	9291	C5770
1617A	C5044	539945	C8029	6306FE	E2208S	6504UE	E3006S	8261	C1160	9463	C8001
1829A	C5775	539949	C8029	6320FE	E2200S	6506FE	E2108S	8263	C1106	9860	C8013
1840A	C5826	5401UE	E1023S	6320FL	E3602S	6506UE	E3008S	8267	C1176	9862	C1162
1841A	C5822	5508UE	E1010S	6320UE	E3030S	6509UE	E3012S	8281B	C5816	9863	C8000
1846A	C5853	5520FE	E2000S	6320UL	E3502S	6520FE	E2100S	9011	C5034	9907	C5779
1847A	C5856	6000UE	E3062S	6321FL	E3503S	6520UE	E3000S	9066	C5804	9913	C1180
5000UE	E1062S	6020FL	E3632S	6321UL	E3604S	6522UE	E3001S	9067	C5844	9999	C8033
5002UE	E1064S	6020UL	E3532S	6322FL	E3604S	6522UL	E3482S	9100	C5780		
5102UE	E1054S	6100FE	E2252S	6322UL	E3504S	7999A	C5044	9106	C5834		
5120LL	E2406S	6100UE	E3052S	6324UL	E3506S	8212	C1102	9108	C5832		

This cross-reference guide should be used in conjunction with the product information contained in our catalog or Website. It should be used for suggested alternative items, which are functionally equal. Constructional differences are not indicated. Prysmian Group is not responsible for variances due to competitor and industry constructional changes or agency updates.

Belden is a registered trademark of Belden, Inc. CAROL BRAND is a registered trademark the Prysmian Group.



Prysmian North America
 4 Tesseneer Drive, Highland Heights, KY 41076
 +1-859-572-8000/na.prysmian.com

NEC/CEC Substitution Chart

Communication wire and cable for premise installations in accordance with Article 800, and other applicable parts of the National Electrical Code (NEC), latest issue. Communication wire and cables for Canada are in accordance with the harmonized Canadian Standard Association C22.2 No. 214, Underwriters Laboratories UL 444, latest issue.

Figure 800-154(E) Cable Substitution Hierarchy

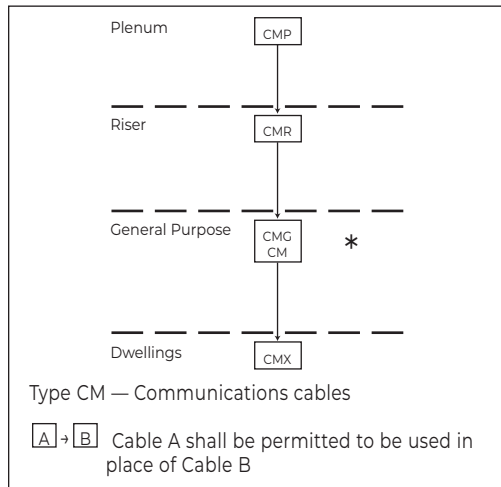

*CMG can be substituted for CM—CM can NOT be substituted for CMG

Figure 725-154(G), Cable Substitution Hierarchy

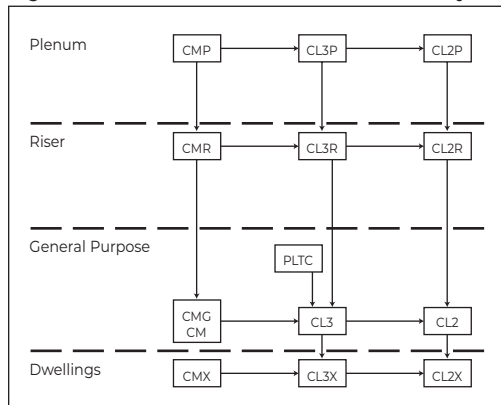

Type CM — Communications wires and cables
 Type CL2 and CL3 — Class 2 and Class 3 remote-control, signaling and power-limited cables
 Type PLTC — Power-limited tray cable

A → B Cable A shall be permitted to be used in place of Cable B

FIRE RESISTANCE LEVEL	TEST REQUIREMENT	NEC ARTICLE			
		800	725	760	820
(Highest) Plenum Cables	NFPA 262 (Steiner Tunnel) CSA-CMP (Steiner Tunnel)	CMP	CL3P CL2P	FPLP	CATVP
Riser Cables	UL-1666 (Vertical Shaft)	CMR	CL3R CL2R	FPLR	CATVR
General-Purpose Cables Multiple Floors	UL-1581 (Vertical Tray) CSA-CMG (Vertical Tray)	CMG CM	CL3	FPL	CATV
(Lowest) Residential Cables Restricted Use	UL-1581 VW-1	CMX	CL2 CL3X		CATVX

Notes: 1. Cables with a higher fire resistance level may be substituted for those with a lower fire resistance level.
 2. Non-fire rated outside plant telephone cables may not run outside of a rigid metal conduit more than 50 feet from the point of entrance into a building.
 3. Cables rated cmg or cm may be used in runs penetrating one floor. (nec 800-53)

ARTICLE 800

Table 800-154(E). Cable Uses and Permitted Substitutions

CABLE TYPE	USE	REFERENCE	PERMITTED SUBSTITUTIONS
CMP (FT6)	Communications plenum cable	800-154(a)	
CMR	Communications riser cable	800-154(b)	CMP
CMG (FT4) CM (FT1)	Communications general purpose cable	800-154(c)	CMP, CMR
CMX (FT1)	Communications cable, limited use	800-154(c)	CMP, CMR, CMG, CM

Note: See Figure 800-154(E), Cable Substitution Hierarchy

ARTICLE 725

Table 725-154(G). Cable Uses and Permitted Substitutions

CABLE TYPE	USE	REFERENCE	PERMITTED SUBSTITUTIONS
CL3P	Class 3 plenum cable	725-61(a)	CMP
CL2P	Class 2 plenum cable	725-61(b)	CMP, CL3P
CL3R	Class 3 riser cable	725-61(b)	CMP, CL3P, CMR
CL2R	Class 2 riser cable	725-6 (b)	CMP, CL3P, CL2P, CMR, CL3R
PLTC	Power-limited tray cable	725-61(c) and (d)	
CL3	Class 3 cable	725-61(b), (e) and (f)	CMP, CL3P, CMR, CL3R, CMG, CM, PLTC
CL2	Class 2 cable	725-61(b), (c) and (f)	CMP, CL3P, CL2P, CMR, CL3R, CL2R, CMG, CM, PLTC, CL3
CL3X	Class 3 cable, limited use	725-61(b) and (e)	CMP, CL3P, CMR, CL3R, CMG, CM, PLTC, CL3, CMX
CL2X	Class 2 cable, limited use	725-61(b) and (e)	CMP, CL3P, CL2P, CMR, CL3R, CL2R, CMG, CM, PLTC, CL3, CL2, CMX, CL3X

Note: See Figure 725-154(G), Cable Substitution Hierarchy

Reprinted with permission from NFPA 70-2008 National Electrical Code®, copyright © 2008, National Fire Protection Association, Quincy, MA 02269. This reprinted material is not the complete and official position of the NFPA on the referenced subject, which is represented only by the standard in its entirety.

National Electrical Code® and the NEC® are registered trademarks of the NFPA.



NEC/CEC Substitution Chart

Figure 760-154 (D), Cable Substitution Hierarchy

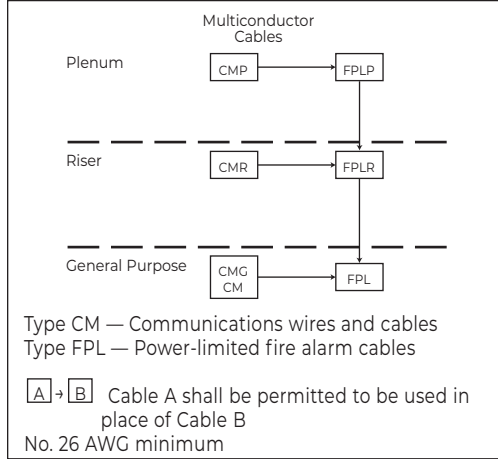

Article 760

Table 760-154 (D). Cable Uses and Permitted Substitutions

CABLE TYPE	USE	REFERENCES	PERMITTED SUBSTITUTIONS
			MULTICONDUCTOR
FPLP	Power-limited fire alarm plenum cable	760-154 (A)	CMP
FPLR	Power-limited fire alarm riser cable	760-154 (B)	CMP, FPLP, CMR
FPL	Power-limited fire alarm cable	760-154 (C)	CMP, FPLP, CMR, FPLR, CMG, CM

Note: See Figure 760-154 (D), Cable Substitution Hierarchy

Figure 820-154 (E), Cable Substitution Hierarchy

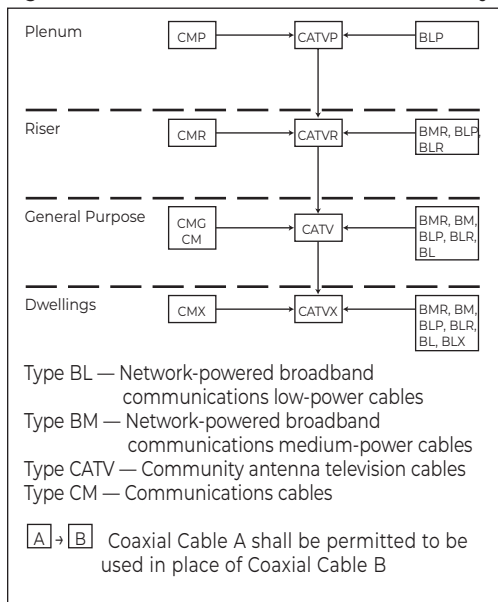

Article 820

Table 820-154 (E). Coaxial Cable Uses and Permitted Substitutions

CABLE TYPE	USE	REFERENCES	PERMITTED SUBSTITUTIONS
CATVP	Coaxial plenum cable	820-154 (A)	CMP, BLP
CATVR	Coaxial riser cable	820-154 (B)	CATVP, CMP, CMR, BMR, BLP, BLR
CATV	Coaxial general purpose cable	820-154 (C)	CATVP, CMP, CATVR, CMR, CMG, CM, BMR, BM, BLP, BLR, BL
CATVX	Coaxial cable, limited use	820-154 (C)	CATVP, CMP, CATVR, CMR, CATV, CMG, CM, BMR, BM, BLP, BLR, BL, BLX

Note: See Figure 820-154 (E), Cable Substitution Hierarchy

Reprinted with permission from NFPA 70-2002 National Electrical Code®, copyright © 2008, National Fire Protection Association, Quincy, MA 02269. This reprinted material is not the complete and official position of the NFPA on the referenced subject, which is represented only by the standard in its entirety.

National Electrical Code® and the NEC® are registered trademarks of the NFPA.

Agency Symbols



UL Listed Mark for the United States



CSA CMP



UL Listed Mark for Canada



CSA CMG



UL Listed Mark for Canada and the United States



CSA CMH



UL Recognized Component Mark for the United States

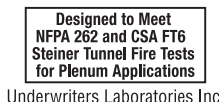

NFPA 262 and CSA FT6 Steiner Tunnel Fire Tests



TIA/EIA 568A Cat. 3



UL Vertical Tray Flame Test



TIA/EIA 568B Cat. 5e & Cat. 6



UL 1666 Riser Flame Test



RoHS Compliant Directive (EU) 2019/863



IMSA



ETL

Put-Ups and Color Codes

PUT-UP CODES

	PULL-PAC®	SPOOL-PAC®	SPOOL	REEL
100'	-	-	12	33
250'	-	-	15	35
500'	25	-	18	38
1000'	30	86	21	41
2000'	-	-	-	43
2500'	-	-	24	44
3000'	-	-	-	52
5000'	-	-	26	46

JACKET COLOR CODES

COLOR	ABBREVIATION	COLOR CODE
Black	BK	01
White	WH	02
Red	RD	03
Orange	OR	04
Yellow	YL	05
Green	GN	06
Blue	BL	07
Brown	BR	08
Gray	GY	10
Pink	PK	13
Light Blue	LB	16
Beige	BG	17
Purple	PU	19
Natural	NT	86
Clear	CL	90

Due to variances in monitors and printed materials, the colors above are only a representation of color and do not necessarily reflect the actual jacket color of the cable.